



Waterloo 1.15 GPM Deck-Mounted Pre-Rinse Faucet with 8" Centers and 6" Add-On Faucet

#750PRD86

Item #: 750PRD86 Qty: _____
 Project: _____
 Approval: _____ Date: _____



Features

- 44" hose, 1.15 GPM spray valve
- Deck-mounted design with 8" centers, 1/2" NPT inlets
- 1/4 turn ceramic cartridges for long life and leak-protection, check valves prevent backflow
- Heavy-duty faucet base and spray valve, chrome-plated brass construction
- 6" add-on faucet (2 GPM), 18" riser

Certifications

 CSA, US and Canada
  NSF Listed
  1/2" Water Connection

Technical Data

Hose Length	44 Inches
Add-On Faucet	6 Inches
Add-on Flow Rate	2 GPM
Cartridge Type	Ceramic
Faucet Centers	8 Inches
Features	ASME A112.18.1-2018 / CSA B125.1-18 California AB100 Compliant NSF/ANSI 372 NSF/ANSI 61
Handle Type	Lever

Technical Data

Material	Brass
Mounting Style	Deck Mounted
Pre Rinse Unit Type	Hose and Spring
Spout Type	Swing
Spray Valve Flow Rate	1.15 GPM
Temperature Rating	180 Degrees Fahrenheit
Water Inlet Size	1/2 Inches

Plan View

750PRD8X

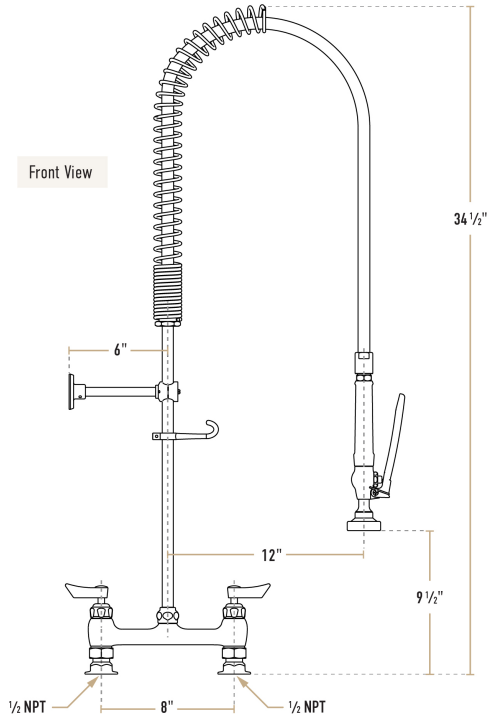

750PRRADAPT

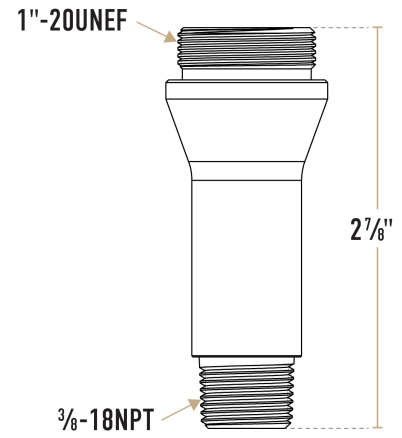

750AF6

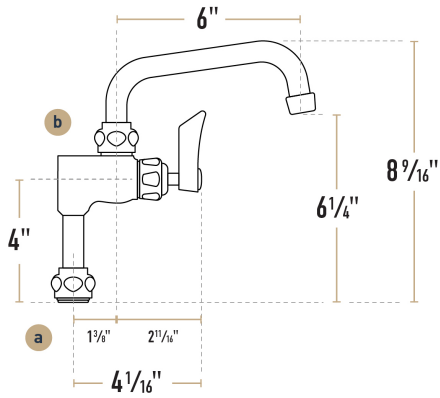

Connections

- a 1/2" NPT Inlet
- b 3/8" NPT Female Inlet

Notes & Details

This Waterloo deck-mounted pre-rinse faucet is perfect for rinsing excess food and sauces off of your dishes prior to running them through your commercial dish machine. A quality pre-rinse unit is vital to any dishroom, removing the heaviest soil deposits so that dishes come out clean and ready to use. Waterloo products provide the industry-leading quality you expect. With heavy chrome-plated brass faucet bodies, ceramic cartridges engineered for durability, and certifications from a wide range of national and local regulatory agencies, you can install Waterloo products with confidence. And to give you total peace of mind, this model comes with a 3-year replacement warranty.

A 44" long flexible hose gives you plenty of reach to deliver water where you need it, letting you handle glassware and dinnerware, or bulky items like pots and pans. The spring has a compressed bottom to provide greater durability and help it retain its shape. The spray valve delivers a flow rate of 1.15 GPM, giving you the power needed to blast away food debris while being easy on your water bill. The heavy-duty valve body is designed with a comfort-grip handle and uses metal components for maximum durability and leak protection. This pre-rinse unit also comes with a 6" add-on faucet, for times when you need a normal faucet instead of a spray valve. It is perfect for filling up sink compartments to complete your warewashing tasks. It's also great for mixing up cleaning solutions in sanitation pails.

This faucet uses ceramic cartridges, which provide a much lower fail rate than the compression cartridges widely used in the industry. In this design, 2 ceramic discs fit together to create a watertight seal when closed. This removes the need for a rubber seat washer, which is one of the most frequently replaced parts on a faucet. This is a deck-mounted faucet, and it comes with 8" centers that make installation easy. A set of 1/2" NPT inlets make it easy to connect it to your facility's water lines. This pre-rinse unit comes with an 18" riser.

⚠ WARNING: This product can expose you to chemicals including lead, which are known to the State of California to cause cancer, birth defects, or other reproductive harm. For more information, go to www.p65warnings.ca.gov.