



## Waterloo Deck Mount Hands-Free Sensor Faucet with 5 1/2" Surgical Bend Gooseneck Spout and 10" Chrome-Plated Faucet Deck Plate

#750EFDMSGSDP8SS

Item #: 750EFDMSGSDP8SS Qty: \_\_\_\_\_

Project: \_\_\_\_\_



Approval: \_\_\_\_\_ Date: \_\_\_\_\_



### Features

- 2.2 GPM flow rate
- Deck-mounted single base, (1) 18" stainless steel supply line to connect module to faucet
- Mixing valve, (2) 18" stainless steel supply lines, 1/2" NPSM x 3/8" female fittings
- Solid chrome-plated brass faucet with chrome-plated stainless steel deck plate for long life
- Includes AC adapter and control module, can operate on batteries

### Certifications

 ADA Compliant
  1-15P
  3/8" Water Connection

 CSA, US and Canada

### Technical Data

Spout Length	5 1/2 Inches
Faucet Height	8 Inches
Battery Type	AA
Faucet Centers	Single
Features	ASME A112.18.1-2018 / CSA B125.1-18 California AB100 Compliant Flex Inlets Included Hands Free NSF/ANSI 372 NSF/ANSI 61

## Technical Data

Finish	Chrome
Flow Rate	2.2 GPM
Material	Brass
Mounting Holes Required	1 Mounting Hole
Mounting Style	Deck Mounted
Pressure Rating	60 PSI
Spout Clearance	5 5/8 Inches
Spout Type	Gooseneck
Temperature Rating	194 Degrees Fahrenheit
Type	Touchless Faucets
Water Inlet Size	3/8 Inches

# Plan View

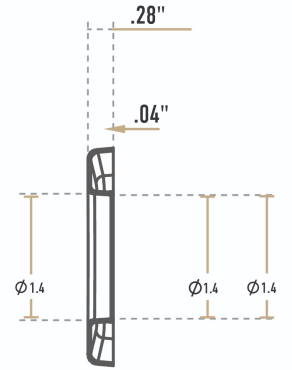
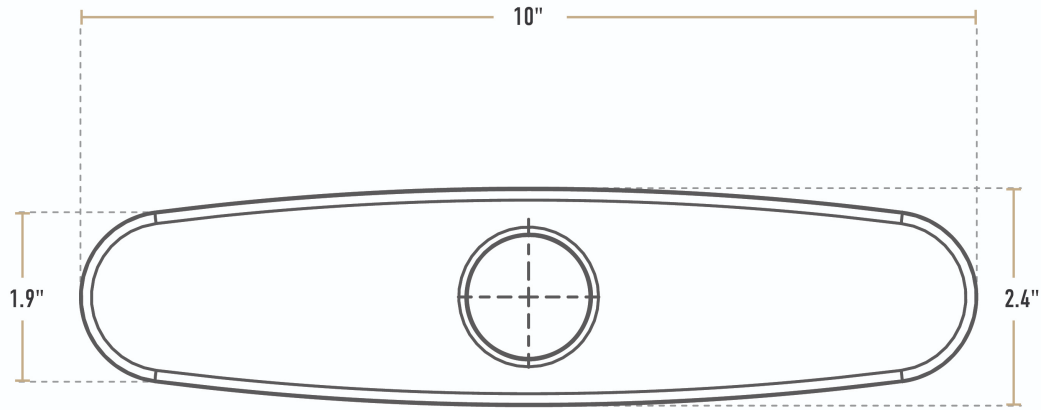

Front View

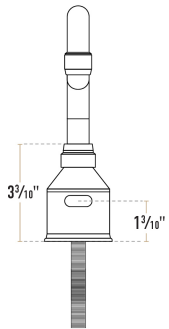

Side View

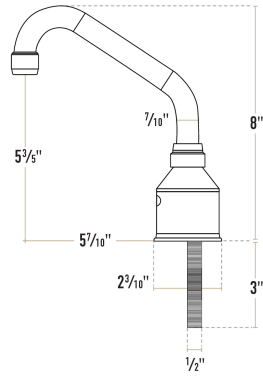

Top View

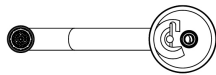

# Notes & Details

---

This Waterloo deck mounted hands-free sensor faucet is the perfect solution when you need a dependable water fixture for your facility's restrooms and hand-washing areas! It features a 5 1/2" long gooseneck spout, with a chrome-plated finish and an attractive rounded base to provide a contemporary and refined look wherever it's installed. Plus, it comes with an 10" deck plate. The deck plate is a great way to create a seamless and attractive connection point between your faucet and the countertop. Made from chrome-plated stainless steel, it provides a polished look and superior durability. Additionally, the spout features a surgical bend design that is perfect for healthcare applications.

It has an infrared proximity sensor with a 30 second timeout feature and an adjustable range of 2-21 cm. Because a sensor activates the water flow, it has several advantages over a traditional handle-style faucet. It is hands-free, which reduces the opportunity for germs to length, and it also prevents the faucet from running when it's not needed, which helps to cut down on your water bill.

The UL certified AC adapter with a Level VI efficiency rating is included to provide power for the faucet's control module, which installs below the countertop and connects to the faucet with an 18" flexible supply line. Or, you can also use (4) AA batteries if an outlet isn't convenient, and to provide backup power in case of an outage. A mixing valve also allows you to easily set the output temperature to the desired level. This prevents burned hands from water that is too hot, while still ensuring that the water is warm enough for users to effectively wash their hands. A pair of 18" flexible stainless steel connectors with 1/2" NPSM female x 3/8" female compression fittings connect the mixing valve to your building's water lines.

Waterloo sensor faucets provide the industry-leading quality you expect. With heavy chrome-plated brass faucet bodies and certifications from a wide range of national and local regulatory agencies, you can install this model with confidence. And to give you total peace of mind, it comes with a 3-year replacement warranty.

 **WARNING:** This product can expose you to chemicals including lead, which are known to the State of California to cause cancer, birth defects, or other reproductive harm. For more information, go to [www.p65warnings.ca.gov](http://www.p65warnings.ca.gov).