

TC 32 NEVADA ICE H

Refrigerated meat grinder, heavy duty

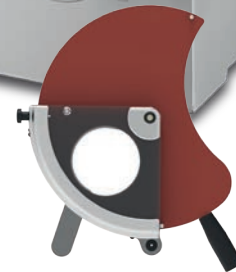

Optional lid



Optional Format M

- Powerful - up to 2.5 Hp - and compact for busy environments where space is at a premium.
- Complete stainless steel construction to withstand heavy-duty application and ensure the highest levels of hygiene.
- Fast and easy breakdown and assembly without tools for thorough cleaning.
- High efficiency air-cooled motor for continuous operation.
- Gear motor with oil-bath transmission and double seal for long-lasting and maintenance-free operation.
- Supplied with one simple cut knife and plate.
- 150 Watt, R134A gas refrigerator.
- Refrigeration on feed tray neck, mincing head and on the whole feed tray.
- IP 67 protection rated controls with reverse.

Optional:

- Interlock protection for more than 8 mm holes plates (An interlock protection system is required in order to utilize more than 8 mm holes plates).
- Partial or total Unger system mincing head.
- Plexiglass feed tray lid.
- Hamburger press attachment FORMAT M.

Features

Technical

- Sealed gear box with hardened gears in oil bath.
- Stainless steel AISI 304 conveying screw and head.
- 5 different plates available (3/16", 7/32", 5/26", 3/8", 9/16").

Safety

- An interlock stops the machine when removing the feed tray.

Sanitary

- Head is completely removable for an easy and fast cleaning and sanitation.

Specifications

- Standard plate:** TC 32: 1/4" (6 mm.)
Motor: 2.5 Hp (1840W), fan cooled.
Electrical: 220V AC, 60Hz 1-phase
Plug and Cord: Attached, flexible, 3 wire SJT 16 AWG, 6'4" long cord.
Controls: ON/OFF/REV stainless steel keypad, IP 67 waterproof protection

FORMAT M

hamburger applications



TC 32 NEVADA ICE H - Optional molds

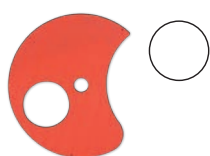

Ø 3 7/8" inch.
h. 9/16" inch.
lbs. 0.31 ±

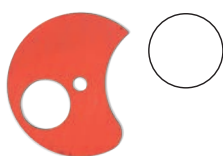

Ø 4 1/3" inch.
h. 9/16" inch.
lbs. 0.34 ±

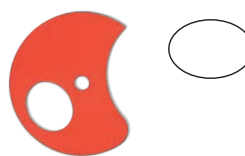

3 3/4" x 4 1/2" inch.
h. 9/16" inch.
lbs. 0.29 ±

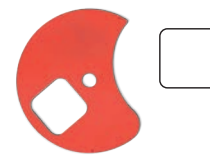

3 7/8" x 3 7/8" inch.
h. 9/16" inch.
lbs. 0.33 ±



3 7/8" x 4 1/8" inch.
h. 9/16" inch.
lbs. 0.42 ±

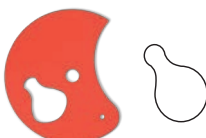

3 7/8" x 4 5/8" inch.
h. 9/16" inch.
lbs. 0.23 ±

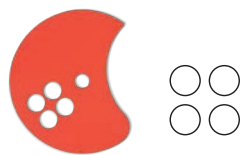

Ø 1 9/16" inch.
h. 9/16" inch.
lbs. 0.044 (x4) ±

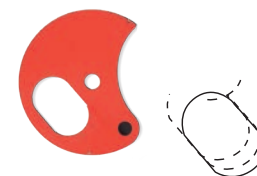

Adjustable 0,22-0,44 lbs.
round to oval
h. 9/16" inch.

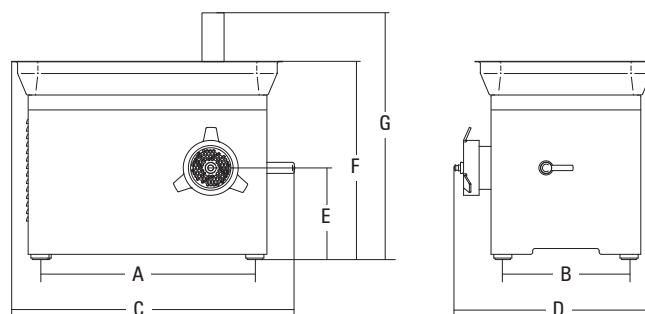

	Power	Power source +/- 10%	Average TC output/h	Standard plate	A	B	C	D	E	F	G	Net weight	Shipping	Gross weight
	watt/Hp		lbs./h.	Ø inch.	inch.	inch.	inch.	inch.	inch.	inch.	inch.	lbs.	inch.	lbs.
TC 32 Nevada Ice H	1840/2.5	220V, 60Hz 1-ph	1433	3/16"	18 ^{57/64} "	11 ^{7/32} "	24 ^{58/64} "	19 ^{31/64} "	4 ^{48/64} "	17 ^{23/32} "	21 ^{58/64} "	132	29 ^{17/32} " x 22 ^{53/64} " x 31 ^{1/2} "	181