



ServIt CFT5 Stainless Steel 5 Pan Ice-Cooled Cold Food Table with Undershaft

#423CFT5

FEATURES

- Fiberglass insulation for excellent temperature retention and 1" diameter IPS drain
- Ice-cooled, requires no electricity or refrigeration connections
- Perfect for cooling a large variety of products from fruit to seafood
- Removable polyethylene 8" deep cutting board provides plenty of extra work space
- Convenient adjustable undershaft provides additional space for utensils, pans, or lids

TECHNICAL DATA

Width	71 3/8 Inches
Depth	30 3/16 Inches
Height	34 Inches
Interior Width	66 15/16 Inches
Interior Depth	20 Inches
Interior Height	8 Inches
Base Style	Undershaft
Features	NSF Listed
Full Size Pan Capacity	5



CERTIFICATIONS



TECHNICAL DATA

Material	Stainless Steel
Style	Ice Cooled
Type	Food Tables

Plan View

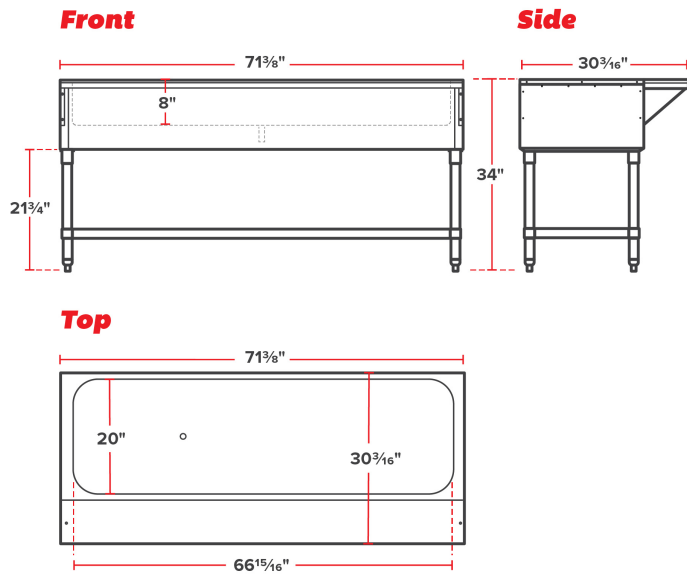

Notes & Details

Chill your seafood, salad ingredients, fruits, and other cold products for hours with this Servit CFT5 stainless steel 5 pan ice-cooled cold food table! Its spacious ice well allows you to place (5) 12" x 20" food pans, or multiple food pans of various sizes, which increases its versatility to perform in self-serve or staff-serve applications. The ice pan slopes down to a 1" IPS drain to facilitate smooth, hassle-free drainage of melted ice and simplify clean up for staff. The pan features fiberglass insulation to guarantee maximum temperature retention and product longevity. An 8" x 71 3/8" white thermoplastic cutting board is included with this table, ensuring you will have a convenient place for preparing food!

The top and bowl of this unit are constructed with 20-gauge 304 stainless steel, which ensures long-term durability in commercial environments while remaining easy to clean. This ice-cooled cold food table also features a 20-gauge undershelf with galvanized steel sockets to provide additional, easy-to-access storage for cooking equipment and supplies. The stainless steel legs provide a sturdy base to support your cold food table with ease!

⚠ WARNING: This product can expose you to chemicals including lead, which are known to the State of California to cause cancer, birth defects, or other reproductive harm. For more information, go to www.p65warnings.ca.gov.