



Regency 30" x 120" 16-Gauge 304 Stainless Steel Commercial Open Base Work Table

#600WT30120SS



Technical Data

Length	30 Inches
Width	120 Inches
Height	34 Inches
Work Surface Height	34 Inches
Backsplash	Without Backsplash
Configuration	Straight
Features	ADA Compliant Customizable Height NSF Listed
Gauge	16 Gauge

Features

- 16-gauge type 304 stainless steel top offers greater durability and corrosion-resistance than type 430
- 1 5/8" stainless steel legs with adjustable plastic bullet feet
- Holds approximately 840 lb.
- Six legs for even weight distribution
- Ideal for a variety of floor layouts

Certifications



NSF Listed



ADA Compliant

Technical Data

Leg Construction	Stainless Steel
Number of Legs	6 Legs
Size	30" x 120"
Stainless Steel Type	Type 304
Table Style	Open Base
Tabletop Material	Stainless Steel
Top Capacity	840 lb.
Usage	Standard Duty

Plan View

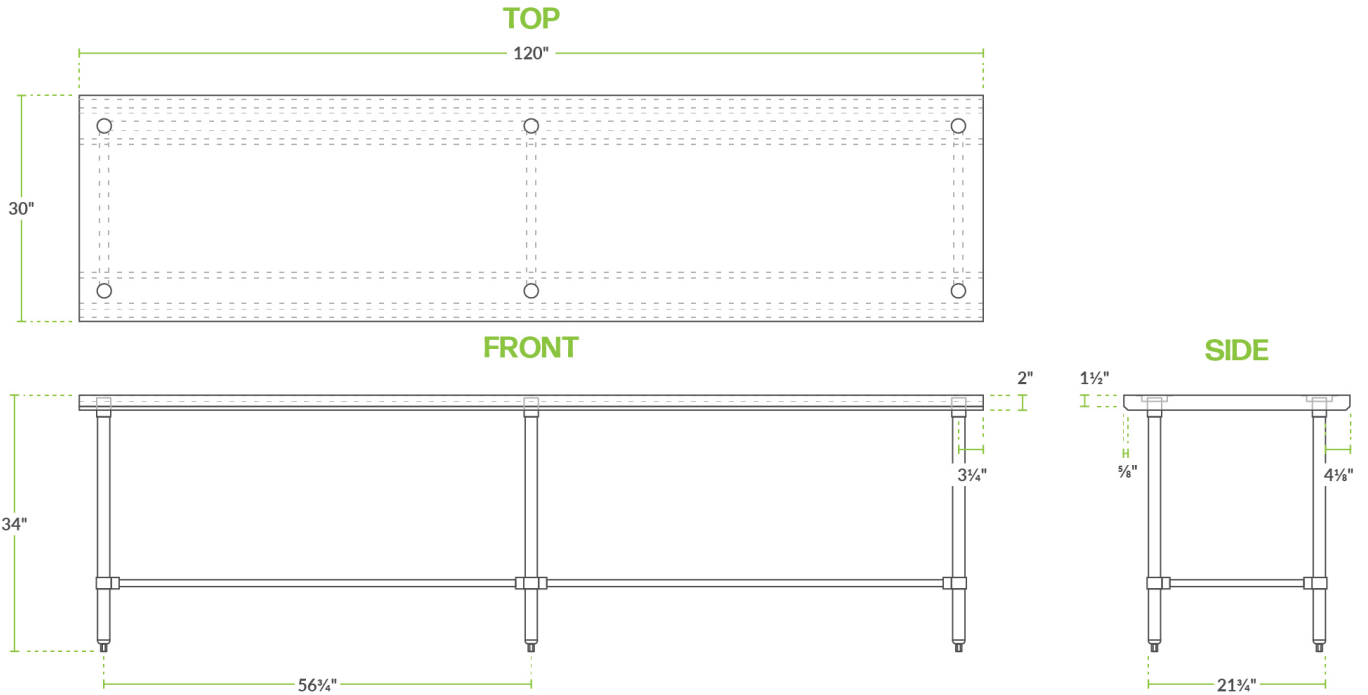

Notes & Details

Add valuable countertop work space to your kitchen with this commercial open base 30" x 120" work table. Constructed from durable, easy-to-clean 16-gauge 304-series stainless steel, it is thicker and sturdier than 18-gauge work tables. Plus, it is corrosion-resistant and especially suited for damp environments to ensure a long service life.

Boasting a maximum weight capacity of approximately 840 lb. and a working height of 34", this work table will provide dependable space for food preparation and other tasks within your commercial kitchen. For additional stability and even weight distribution, this open base commercial work table features 1 1/4" diameter stainless steel bracing and six 1 5/8" diameter tubular stainless steel legs with adjustable bullet feet.

⚠ WARNING: This product can expose you to chemicals including Lead and Nickel, which are known to the State of California to cause cancer, birth defects, or other reproductive harm. For more information, go to www.p65warnings.ca.gov.