

**REGENCY**  
Tables and Sinks

## Regency 24" x 36" 16-Gauge 304 Stainless Steel Commercial Open Base Work Table with 4" Backsplash

#600WT24X36BS



### Technical Data

Length	36 Inches
Width	24 Inches
Height	38 Inches
Backsplash Height	4 Inches
Work Surface Height	34 Inches
Backsplash	With Backsplash
Configuration	Straight
Features	Customizable Height NSF Listed
Gauge	16 Gauge

### Features

- 16-gauge type 304 stainless steel top offers greater durability and corrosion-resistance than type 430
- Stainless steel cross bracing and bullet feet add stability
- 4" backsplash contains spills and keeps items from falling off the back
- 530 lb. weight capacity
- Perfect for a variety of prep tasks

### Certifications



## Technical Data

Leg Construction	Stainless Steel
Number of Legs	4 Legs
Size	24" x 36"
Stainless Steel Type	Type 304
Table Style	Open Base
Tabletop Material	Stainless Steel
Top Capacity	530 lb.
Usage	Standard Duty

## Plan View

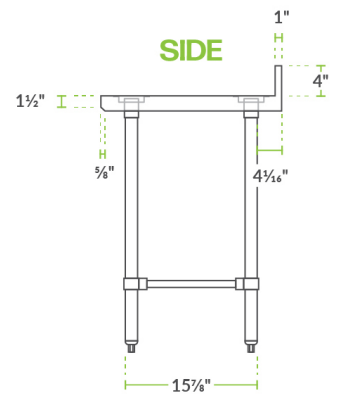
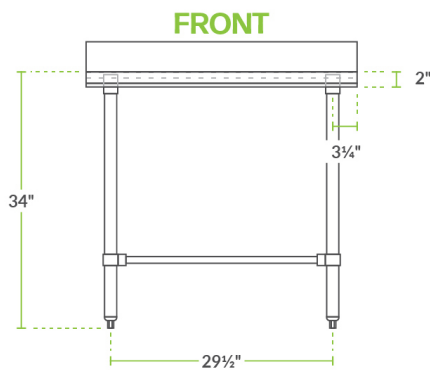
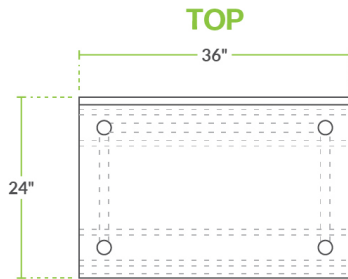

## Notes & Details

This Regency 24" x 36" commercial open base work table with a 4" backsplash is constructed from durable, easy-to-clean 16-gauge type 304 stainless steel. It is designed to provide additional space for food preparation and other tasks within your commercial kitchen. Due to its all-stainless steel construction, this work table is corrosion-resistant and even suited for damp environments.

The four legs and adjustable feet of this work table are also made of tubular stainless steel, ensuring long-lasting performance under heavy use for years to come. This work table features a 4" backsplash with a 1" return to help prevent messy spills and keep your prep supplies from falling off the back. The table has a maximum weight capacity of approximately 530 lb. of evenly distributed weight.

**WARNING:** This product can expose you to chemicals including Lead and Nickel, which are known to the State of California to cause cancer, birth defects, or other reproductive harm. For more information, go to [www.p65warnings.ca.gov](http://www.p65warnings.ca.gov).