

REGENCY
Tables and Sinks

Regency 36" x 15" 16-Gauge Stainless Steel Filler Table With Backsplash

#600WT15X36BS



Technical Data

Length	15 Inches
Width	36 Inches
Height	35 1/2 Inches
Backsplash Height	1 1/2 Inches
Work Surface Height	34 Inches
Backsplash	With Backsplash
Base Style	Open
Configuration	Straight
Features	NSF Listed
Gauge	16 Gauge

Features

- Durable, corrosion-resistant 16-gauge type 304 stainless steel top
- 1 5/8" galvanized legs and adjustable bullet feet
- Holds approximately 450 lb.
- 1 1/2" backsplash to prevent spills
- Designed to fit in between to pieces of equipment

Certifications



Technical Data

Leg Construction	Galvanized Steel
Size	36" x 15"
Stainless Steel Type	Type 304
Tabletop Material	Stainless Steel
Top Capacity	450 lb.
Type	Filler Tables
Usage	Standard Duty

Plan View

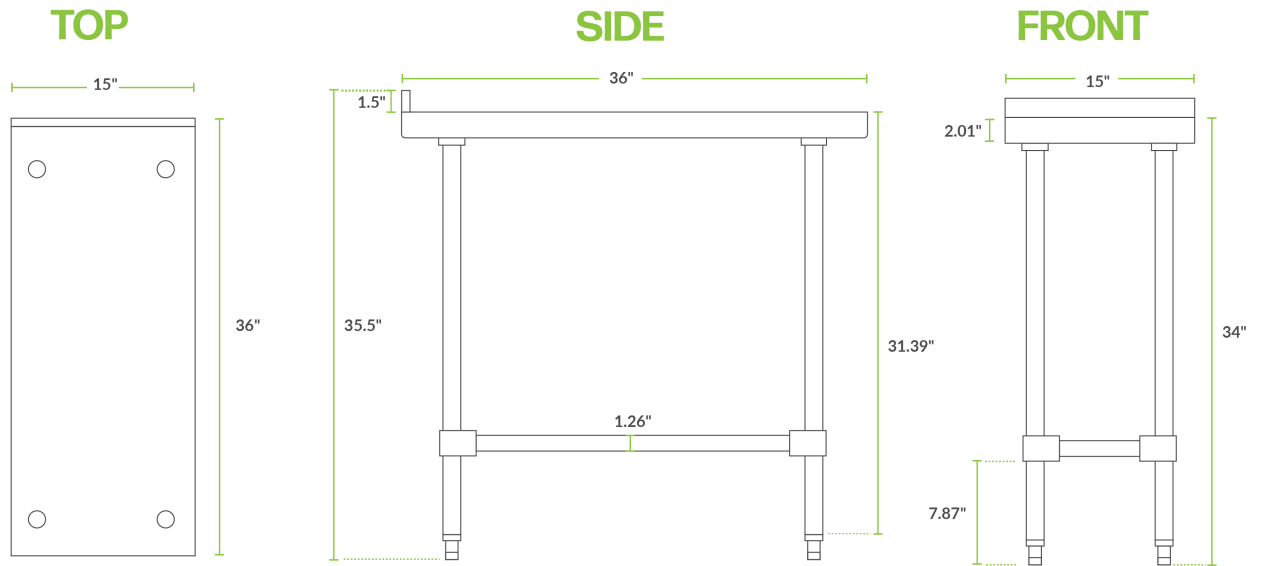

600WT15X36BS

Notes & Details

This stainless steel commercial 36" x 15" equipment filler table with 1 1/2" backsplash is designed to help you maximize the space in your kitchen and make use of unused areas between equipment. The top shelf is made of durable and easy-to-clean 16-gauge type 304 stainless steel, which offers excellent durability and corrosion resistance compared to other types of stainless steel. And with a thin, 15" long footprint, this table easily fits between kitchen equipment to provide additional work space for food preparation, storage space for commonly-used supplies, and any other use that requires a stable work space in a narrow footprint!

The work table features an open base design, supported with aluminum corner brackets. A 1 1/2" high backsplash is included to help protect walls from splashes and to also keep items from falling off the table. The legs of this work table are 1 5/8" in diameter and feature adjustable plastic feet, allowing you to account for uneven floors and keep your work surface level. The legs and hat channels are made from corrosion-resistant 18-gauge galvanized steel. All installation hardware, including the necessary screws and Allen Wrench, are included.

⚠️ WARNING: This product can expose you to chemicals including lead, which are known to the State of California to cause cancer, birth defects, or other reproductive harm. For more information, go to www.p65warnings.ca.gov.