

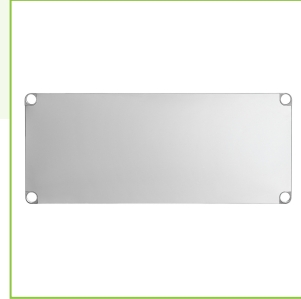

Regency Adjustable Stainless Steel Work Table Undershef for 24" x 48" Tables - 18 Gauge

#600UT2448S



Technical Data

Length	42 Inches
Width	18 Inches
Adjustable Height	Adjustable
Compatible Table Size	24" x 48"
Gauge	18 Gauge
Material	Stainless Steel

Features

- Made of 18 gauge, type 430 stainless steel
- Adjustable
- Increases storage space
- Corrosion-resistant
- Works with Regency 24" x 48" stainless steel work tables

Plan View

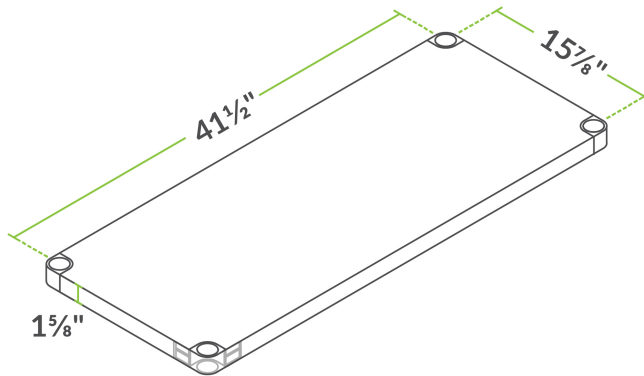

Notes & Details

Add valuable storage space to your Regency work table with this Regency adjustable stainless steel work table undershelf! This undershelf will work with 24" x 48" tables to provide an extra shelf for storing items like frequently used prep tools, cutting boards, bar towels, oven mitts, pans, trays, and more! Since this shelf is adjustable, you can move it higher or lower to accommodate larger items like some types of light equipment or large mixing bowls.

This work table undershelf is made of 18 gauge, type 430 stainless steel to ensure durability and corrosion resistance. Stainless steel is a great choice for food prep areas since it is easy to clean and sanitize, plus it provides a sleek, professional appearance that will fit right in to your commercial kitchen. Accessorize your work table with this undershelf to ensure a stable, sanitary storage area for commonly used items that you want to keep within arms' reach.

This undershelf is designed to fit 24" x 48" Regency work tables. Its actual dimensions are 6" shorter than the table in length and width because the table legs are set in under the table top.

⚠ WARNING: This product can expose you to chemicals including lead, which are known to the State of California to cause cancer, birth defects, or other reproductive harm. For more information, go to www.p65warnings.ca.gov.