



Regency 42" x 21" Stainless Steel Dish Table Undershef for 4' Dish Tables

#600UDT2442



Technical Data

Length	42 Inches
Width	20 7/8 Inches
Height	10 Inches
Features	NSF Listed
Gauge	18 Gauge
Material	Stainless Steel
Stainless Steel Type	Type 304
Type	Undershelves

Features

- Adds quick and convenient storage space below your dish tables
- Constructed of durable 18 gauge type 304 stainless steel
- Designed to fit 4' dish tables

Certifications



Plan View

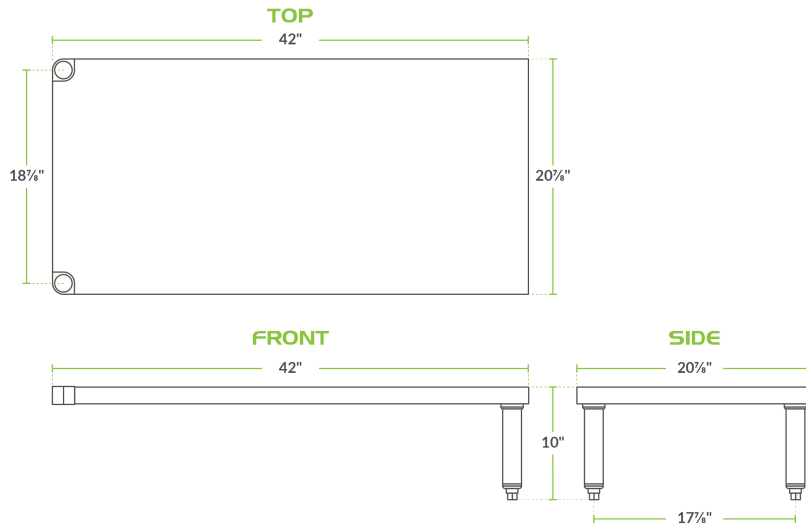

Notes & Details

Use this Regency 42" x 21" stainless steel dish table undershelf to easily add quick and convenient storage space below your dish tables. It's constructed of durable 18 gauge type 304 stainless steel, and it features 10" high legs on one side. This undershelf is designed to fit 4' dish tables.

⚠ WARNING: This product can expose you to chemicals including lead, which are known to the State of California to cause cancer, birth defects, or other reproductive harm. For more information, go to www.p65warnings.ca.gov.