



Regency 30" x 36" 16-Gauge 304 Stainless Steel Commercial Work Table with Undershaft

#600TS3036S



Technical Data

Length	36 Inches
Width	30 Inches
Height	34 Inches
Work Surface Height	34 Inches
Backsplash	Without Backsplash
Base Style	Undershelf
Features	Customizable Height NSF Listed With Undershelf
Gauge	16 Gauge

Features

- 16-gauge type 304 stainless steel top offers greater durability and corrosion-resistance than type 430
- 18-gauge type 430 stainless steel adjustable undershaft
- 1 5/8" stainless steel legs with adjustable metal bullet feet
- Top shelf holds approximately 570lb.
- Undershelf holds approximately 350 lb.

Certifications



Technical Data

Leg Construction	Stainless Steel
Number of Legs	4 Legs
Size	30" x 36"
Stainless Steel Type	Type 304
Table Style	Undershelf
Tabletop Material	Stainless Steel
Top Capacity	570 lb.
Undershelf Capacity	350 lb.
Undershelf Construction	Stainless Steel
Usage	Standard Duty

Plan View

FRONT

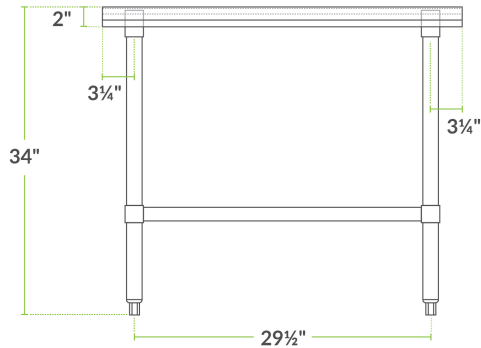

TOP

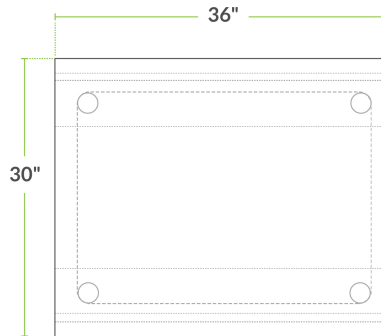

SIDE

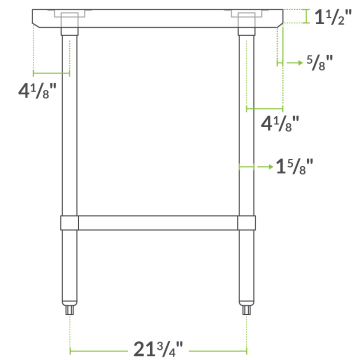

600TS3036S

Notes & Details

Utilize the space in your kitchen with this dependable 30" x 36" 16-gauge, 304-series stainless steel commercial work table from Regency Tables and Sinks. This unit not only provides plenty of room on its work surface, but also offers an 18-gauge, 430-series stainless steel undershelf to supply much needed space for food preparation, storing supplies, and other tasks within your business.

This Regency work table is both easy to clean and easy to maintain thanks to its durable, corrosion resistant material. Plus, it is mounted on (4) sturdy, 1 5/8" stainless steel legs with adjustable, metal, bullet feet for ample support. The top shelf boasts a weight capacity of approximately 570 lb., while the undershelf supports 350 lb.! This amount of strength is extremely valuable in a restaurant or bar.

WARNING: This product can expose you to chemicals including Lead and Nickel, which are known to the State of California to cause cancer, birth defects, or other reproductive harm. For more information, go to www.p65warnings.ca.gov.