



Regency 36" x 18" 18-Gauge 304 Stainless Steel Equipment Filler Table with Backsplash and Galvanized Undershaft

#600TB3618G



Technical Data

Length	18 Inches
Width	36 Inches
Height	38 Inches
Backsplash Height	4 Inches
Work Surface Height	34 Inches
Backsplash	With Backsplash
Base Style	Undershaft
Features	NSF Listed
Gauge	18 Gauge
Leg Construction	Galvanized Steel

Features

- 18-gauge type 304 stainless steel top shelf
- Galvanized steel undershaft and legs with adjustable plastic bullet feet
- Designed to fit in between two pieces of equipment
- 4" backsplash helps prevent spills
- Aluminum corner brackets on undershaft

Certifications



Technical Data

Number of Legs	4 Legs
Size	36" x 18"
Stainless Steel Type	Type 304
Table Style	Undershelf
Tabletop Material	Stainless Steel
Top Capacity	450 lb.
Type	Filler Tables
Undershelf Capacity	320 lb.
Undershelf Construction	Galvanized Steel
Usage	Light Duty

Plan View

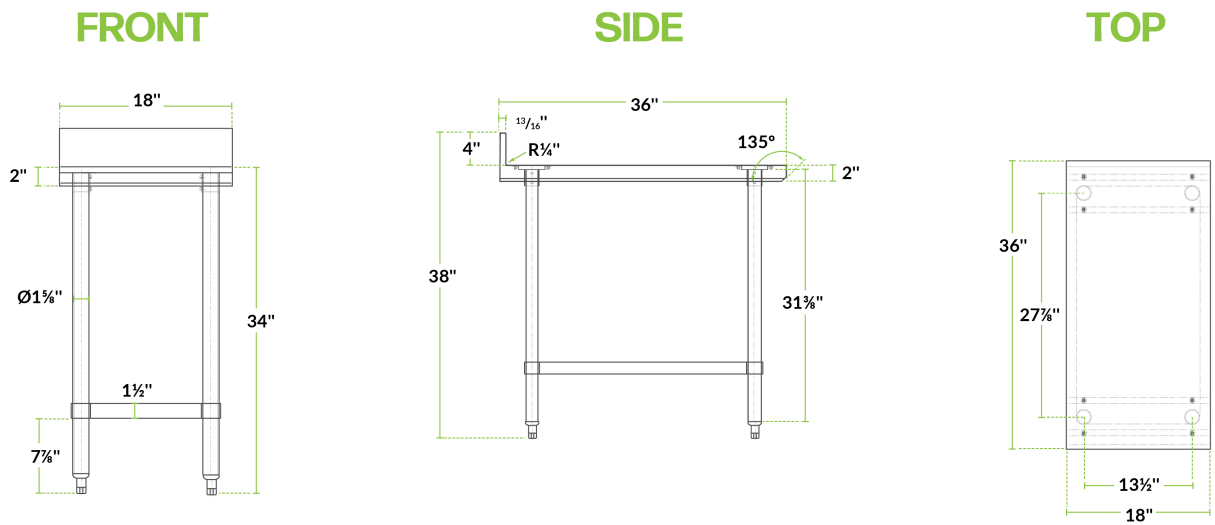

600TB3618G

Notes & Details

This Regency stainless steel commercial 36" x 18" equipment filler table with a 4" high backsplash and undershelf is designed to help you maximize the space in your kitchen. The top shelf is made of durable and easy-to-clean 18-gauge type 304 stainless steel, offering excellent durability and a professional looking finish. With its narrow, 18" profile, this table easily fits between kitchen equipment to provide important extra work space for food preparation, storage supplies, and other tasks within your business.

The work table's adjustable undershelf is constructed from 18-gauge galvanized steel and is further supported with aluminum corner brackets. A 4" high backsplash is included to help protect walls and contain items on the work top. The legs of this work table are 1 5/8" in diameter and are also made of galvanized steel, with plastic feet that are adjustable up to 1".

⚠ WARNING: This product can expose you to chemicals including lead, which are known to the State of California to cause cancer, birth defects, or other reproductive harm. For more information, go to www.p65warnings.ca.gov.