



Regency 24" x 84" 18-Gauge 304 Stainless Steel Commercial Work Table with Galvanized Legs and Undershef

#600T2484G



Technical Data

Length	84 Inches
Width	24 Inches
Height	34 Inches
Work Surface Height	34 Inches
Backsplash	Without Backsplash
Base Style	Undershef
Features	Customizable Height NSF Listed With Undershef
Gauge	18 Gauge

Features

- 18-gauge type 304 stainless steel top offers greater durability and corrosion-resistance than type 430
- Includes a galvanized undershef and legs
- Features a 24" x 84" work top
- Adjustable feet provide stability
- 650 lb. top shelf weight capacity; 450 lb. undershef weight capacity

Certifications



Technical Data

Leg Construction	Galvanized Steel
Number of Legs	6 Legs
Size	24" x 84"
Stainless Steel Type	Type 304
Table Style	Undershelf
Tabletop Material	Stainless Steel
Top Capacity	650 lb.
Undershelf Capacity	450 lb.
Undershelf Construction	Galvanized Steel
Usage	Light Duty

Plan View

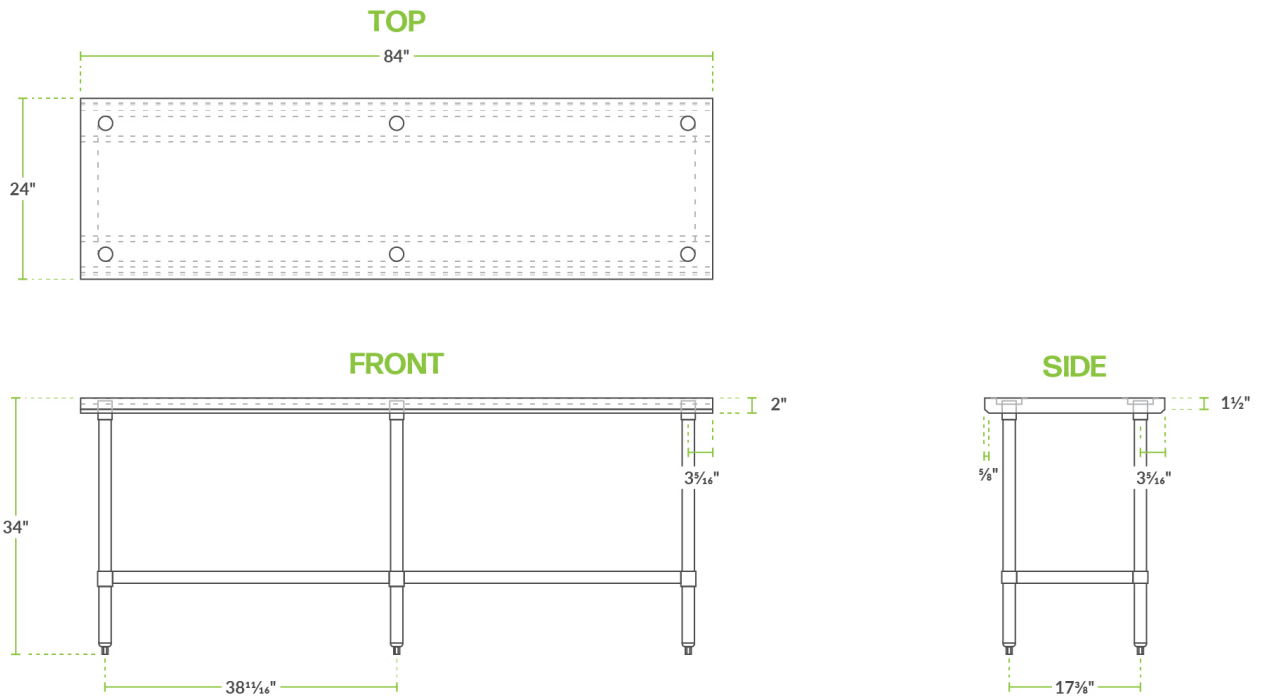

Notes & Details

This Regency 24" x 84" stainless steel commercial work table with undershelf provides additional work space in your busy kitchen. Great for prepping entrees, sides, and desserts, it's constructed from 18-gauge, 304 series stainless steel which offers greater durability and corrosion resistance than type 430 stainless steel. It has a smooth, easy-to-clean surface which makes this work table an ideal addition to your establishment. With the ability to hold up to 650 lb. of evenly distributed weight on the top shelf and 450 lb. on the undershelf, this work table provides additional storage options in crowded kitchens or tight work spaces.

The adjustable, galvanized steel undershelf should be placed 6" off of the ground when used in food service applications to comply with food safety regulations. Plus, a height of 34" allows you to can create a comfortable work station for your employees. For increased stability, the legs of this work table are 1 5/8" in diameter and are also made of tubular galvanized steel, with plastic feet that are adjustable up to 1" to best fit your needs!

WARNING: This product can expose you to chemicals including Lead and Nickel, which are known to the State of California to cause cancer, birth defects, or other reproductive harm. For more information, go to www.p65warnings.ca.gov.