



Regency 18" x 20" 14-Gauge Stainless Steel Fabricated Weld-In Undermount Sink Bowl - 12" Deep

#600SWB182012



Technical Data

Length	18 Inches
Width	20 Inches
Height	12 Inches
Bowl Depth	12 Inches
Bowl Front to Back	20 Inches
Bowl Left to Right	18 Inches
Color	Silver
Corner Radius	3/4 Inch
Drain Opening	3 1/2 Inches
Edge Style	Flush

Features

- Constructed of heavy-duty 14-gauge, type 304 stainless steel
- Approved for NSF welded fabrication
- Includes (1) 18" x 20" x 12" bowl with R19 corner radius
- Undermount style with a flush edge and a sleek satin finish
- 3 1/2" drain opening

Certifications



Technical Data

Features	Massachusetts Accepted Plumbing Product NSF Listed
Gauge	14 Gauge
Material	Stainless Steel
Number of Compartments	1 Compartment
Stainless Steel Type	Type 304
Type	Undermount Sinks Weld-In Sinks

Plan View

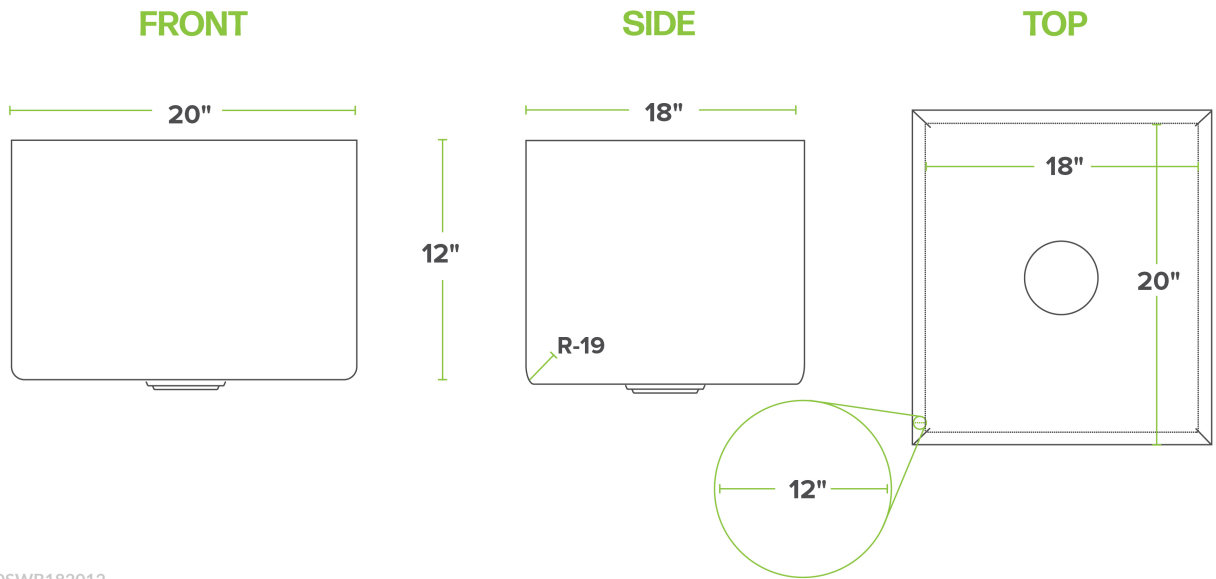

600SWB182012

Notes & Details

Equip your prep kitchen, bar, or other commercial space with this Regency 18" x 20" x 12" 14-gauge stainless steel fabricated weld-in undermount sink bowl. Designed for professional weld-in installation, this sink allows for custom fabrication to accommodate your specific installation requirements. With its undermount design, flush edge style, and R19 sink bowl corner radius, the sink secures to the bottom of a countertop for a seamless installation and a professional appearance.

Designed for long-lasting durability, corrosion resistance, and sanitation, this sink bowl is constructed of heavy-duty 14-gauge, type 304 stainless steel with a sleek satin finish inside and out. To get your new sink up and running as quickly as possible, this bowl is equipped with a 3 1/2" drain opening. This unit is ideal for a variety of janitorial and commercial kitchen applications.

WARNING: This product can expose you to chemicals including lead, which are known to the State of California to cause cancer, birth defects, or other reproductive harm. For more information, go to www.p65warnings.ca.gov.