

REGENCY
Tables and Sinks

Regency Stainless Steel Single Deck Overshelf - 18" x 36" x 19 1/4"

#600SOS1836



Technical Data

Length	36 Inches
Width	18 Inches
Height	19 1/4 Inches
Adjustable Height	Fixed
Capacity	500 lb.
Features	NSF Listed
Gauge	18 Gauge
Material	Stainless Steel
Mounting Style	Side Mounted
Stainless Steel Type	Type 430

Features

- Made of 18 gauge, type 430 stainless steel
- Strong and durable
- Designed for added capacity and organization
- Adds valuable storage space to your kitchen
- Holds up to 500 lb. of weight

Certifications



Technical Data

Style	Single
Top Shelf Capacity	500 lb.
Type	Shelves

Plan View

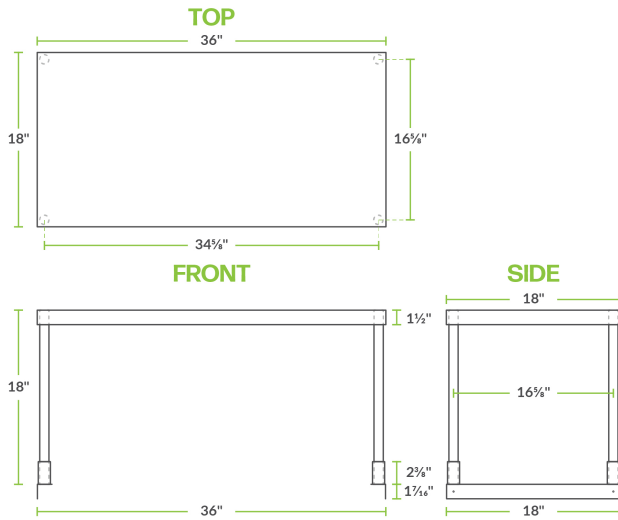

Notes & Details

Add extra storage space and organization to your kitchen with the Regency stainless steel single deck overshelf! This overshelf allows you to maximize the available space of your kitchen. Its stainless steel construction ensures long-lasting durability to stand up to repeated use, and the whole shelf easily mounts to the end of your table using the "L" brackets, set screws, and wrench provided.

The shelf is made of 18 gauge, type 430 stainless steel for excellent corrosion resistance and durability. The single shelf design allows you to better organize your spices and seasoning, pans, cotton towels, oven mitts, and other frequently use cooking and preparation items while keeping them all within easy reach. In total, it holds up to 500 lb. of weight. It also ships knocked down to reduce the cost of shipping.

⚠ WARNING: This product can expose you to chemicals including lead, which are known to the State of California to cause cancer, birth defects, or other reproductive harm. For more information, go to www.p65warnings.ca.gov.