

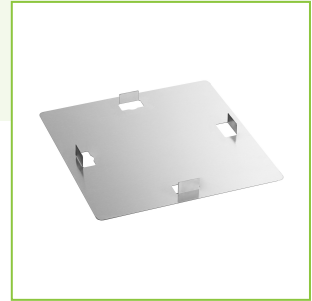

Regency 18 Gauge Stainless Steel Sink Cover for 15" x 15" Bowls

#600SCSS1515

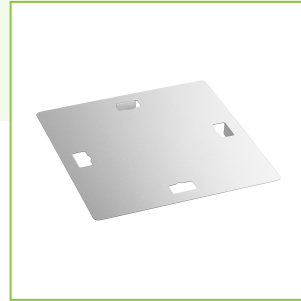

Technical Data

Length	16 1/2 Inches
Width	16 1/2 Inches
Gauge	18 Gauge
Material	Stainless Steel
Type	Covers

Features

- Compatible with 15" x 15" Regency sink bowls
- Provides additional working space
- 18 gauge stainless steel construction
- Includes holes for easy handling

Plan View

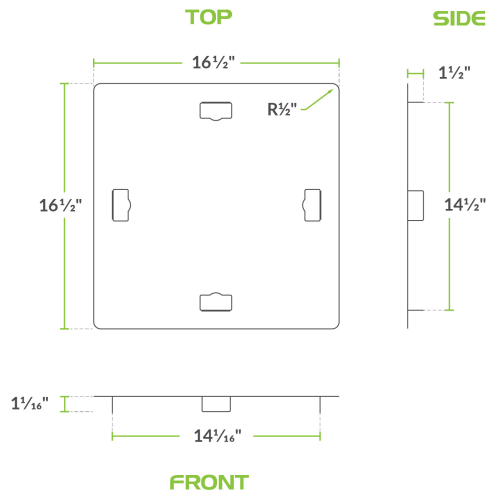

Notes & Details

This Regency sink bowl cover easily slides over top of your sink bowl to provide added light-duty work space! It's compatible with 15" x 15" Regency sink bowls and works as a simple solution for logistical challenges. This cover has holes so that you can easily grasp and lift it away when needed. As an added benefit, the 18 gauge stainless steel construction is durable and easy to clean.

⚠ WARNING: This product can expose you to chemicals including lead, which are known to the State of California to cause cancer, birth defects, or other reproductive harm. For more information, go to www.p65warnings.ca.gov.