



Regency 61" 16 Gauge Stainless Steel Three Compartment Commercial Corner Sink with 2 Drainboards - 20" x 20" x 14" Bowls

#600S32020XC



Technical Data

Length	61 Inches
Width	25 1/2 Inches
Height	42 1/4 Inches
Drainboard Length	18 Inches
Bowl Depth	14 Inches
Bowl Front to Back	20 Inches
Bowl Left to Right	20 Inches
Faucet Centers	8 Inches
Features	NSF Listed
Gauge	16 Gauge

Features

- Made of high-quality 16 gauge, type 304 stainless steel
- Corner design for maximum space-efficiency; H-shape cross braces on legs provide structural support
- Stainless steel legs, sockets, and bullet feet for maximum strength and longevity
- Includes 1 1/2" IPS drain connection and 3 1/2" basket strainers
- Two sets of faucet holes pre-punched on 8" centers (faucet sold separately)

Certifications



Technical Data

Installation Type	Freestanding
Leg Construction	Stainless Steel
Material	Stainless Steel
Number of Compartments	3 Compartments
Number of Drainboards	2 Drainboards
Stainless Steel Type	Type 304
Style	2 Drainboards
Type	Corner Sinks

Plan View

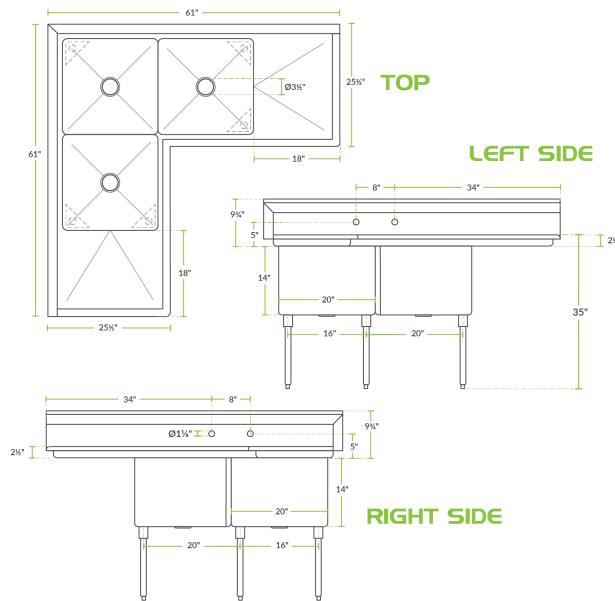

Notes & Details

Wash, prep, or clean with ease when you use this Regency 61" three compartment commercial corner sink with two 18" drainboards. Made of high-quality 16 gauge, type 304 stainless steel for reliable service, this gauge is thicker and much more durable than many similar sinks available. Additionally, type 304 stainless steel is exceptionally corrosion-resistant and easy to clean!

Specially designed to fit into a corner, this compartment sink allows you to make the most of space in your dishroom that might otherwise be underutilized. Each compartment offers rounded corners and ample space to either wash, rinse, or sanitize your items as needed. In addition, the drains include 3 1/2" basket strainers to eliminate the possibility of clogging. By regularly maintaining your drainage system, you will cut down on possible service and replacement costs.

Thanks to the high backsplash, water splashes will be confined inside the sink and then directly drip down into the drain. This added feature helps maintain the integrity of your wall and floor to keep your establishment in its best condition. Plus, this sink has holes pre-punched to accept a faucet on either the back or side (faucet sold separately). This model has stainless steel legs and adjustable stainless steel bullet feet to keep the sink level and stable.

WARNING: This product can expose you to chemicals including lead, which are known to the State of California to cause cancer, birth defects, or other reproductive harm. For more information, go to www.p65warnings.ca.gov.