



Regency 91" 16-Gauge Stainless Steel Three Compartment Commercial Sink with Stainless Steel Legs, Cross Bracing, and 2 Drainboards - 17" x 17" x 12" Bowls

#600S31718X



Technical Data

Length	91 Inches
Width	22 1/2 Inches
Height	44 3/4 Inches
Drainboard Length	18 Inches
Bowl Depth	12 Inches
Backsplash Height	8 1/4 Inches
Work Surface Height	36 1/2 Inches
Basket Drain Size	3 1/2 Inches
Bowl Front to Back	17 Inches
Bowl Left to Right	17 Inches

Features

- Made of high-quality 16 gauge, type 304 stainless steel
- Designed with (3) 12" deep bowls and rounded corners for easy cleaning
- Stainless steel legs, sockets, bullet feet, and crossbracing for maximum strength and longevity
- Includes 1 1/2" IPS drain connection and 3 1/2" basket strainers
- Backsplash and rolled edges prevent splashes and overflow

Certifications



Technical Data

Drain Outlet Size	1 1/2 Inches
Faucet Centers	8 Inches
Features	NSF Listed
Gauge	16 Gauge
Leg Construction	Stainless Steel
Material	Stainless Steel
Number of Compartments	3 Compartments
Number of Drainboards	2 Drainboards
Stainless Steel Type	Type 304
Style	2 Drainboards
Type	Straight / Line Sinks

Plan View

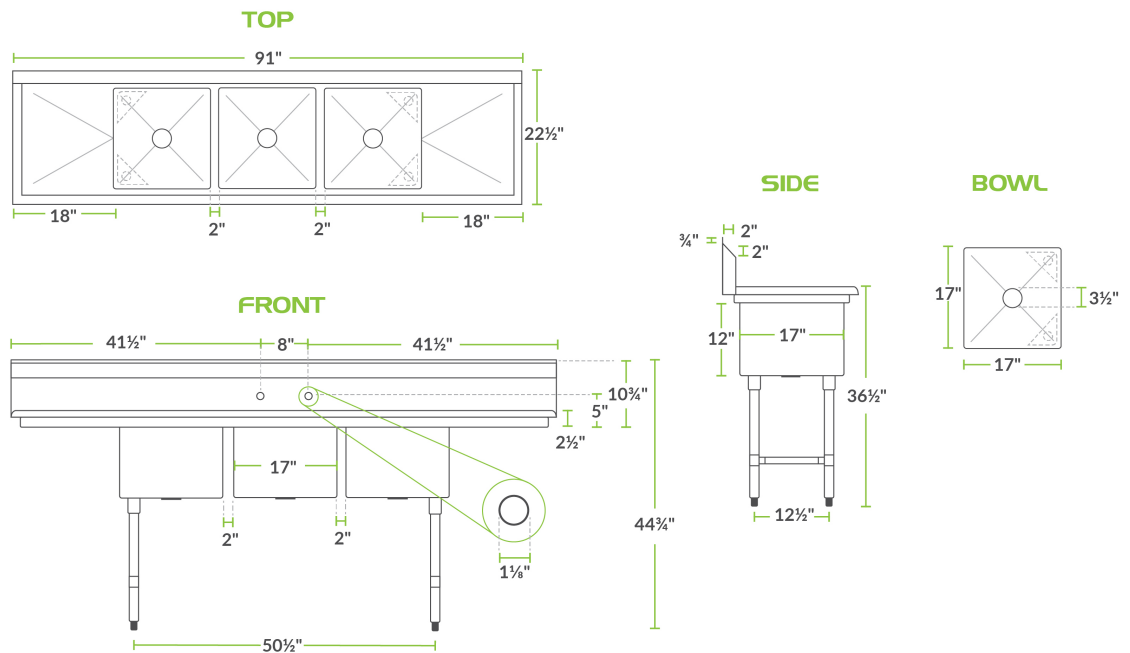

Notes & Details

Outfit your facility with a long-lasting sink with this Regency 91" stainless steel three compartment sink with 2 drainboards. It's constructed from high-quality, 16-gauge type 304 stainless steel, making it more corrosion-resistant and durable than other sinks made from thinner, 18-gauge material. This sink features 2 sturdy, 18" drainboards so you can easily wash and dry dishes and utensils in one convenient location. It's also dipped a minimum of 1/4" to facilitate better drainage, and the welded construction contributes to the long-lasting use and overall strength of this sink / drainboard combo.

The 12" deep bowls are die-stamped to a minimum of 1/4" to ensure proper drainage. Plus, each bowl includes a 3 1/2" basket strainer to catch food debris, which prevents the drain from clogging. For easy cleaning, each compartment has rounded corners so you can rinse and wipe down the sink.

A 8 1/4" tall backsplash is included and comes complete with (2) 1 1/8" diameter holes punched on 8" centers to accommodate 1 faucet (sold separately). This sink also includes a 1 1/2" raised rolled edge, which is 2" tall on the front and both sides to contain splashes and overflow. The legs are constructed of 1 5/8" diameter stainless steel with stainless steel cross-bracing and adjustable plastic feet for added stability. These features serve to prolong the life of your sink while adding exceptional strength to the unit.

 **WARNING:** This product can expose you to chemicals including lead, which are known to the State of California to cause cancer, birth defects, or other reproductive harm. For more information, go to www.p65warnings.ca.gov.