



Regency 58" 16-Gauge Stainless Steel Three Compartment Commercial Sink with Galvanized Steel Legs and 2 Drainboards - 10" x 14" x 10" Bowls

#600S3101412G



Technical Data

Length	58 Inches
Width	19 1/2 Inches
Height	43 3/4 Inches
Drainboard Length	12 Inches
Bowl Depth	10 Inches
Work Surface Height	36 1/2 Inches
Basket Drain Size	3 1/2 Inches
Bowl Front to Back	14 Inches
Bowl Left to Right	10 Inches
Drain Outlet Size	1 1/2 Inches

Features

- 16-gauge type 304 stainless steel sink with galvanized steel legs and adjustable plastic feet
- Compact design is perfect for locations with limited space
- Galvanized steel legs with adjustable bullet feet for added stability
- Includes 1 1/2" IPS drain connection and 3 1/2" basket strainers
- Backsplash and rolled edges prevent splashes and overflow

Certifications



Technical Data

Faucet Centers	8 Inches
Features	NSF Listed
Gauge	16 Gauge
Leg Construction	Galvanized Steel
Material	Stainless Steel
Number of Compartments	3 Compartments
Number of Drainboards	2 Drainboards
Stainless Steel Type	Type 304
Style	2 Drainboards
Type	Straight / Line Sinks

Plan View

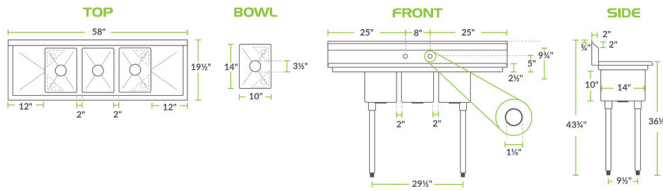

Notes & Details

Install a convenient sink and work area in your business with the Regency three compartment stainless steel commercial sink! This compartment sink is made of 16-gauge type 304 stainless steel for long-lasting durability and exceptional resistance to corrosion to guarantee longevity. Each sink bowl measures 10" x 14" with a 10" depth to hold water, sanitizer, dishes, and more, while (3) 3 1/2" basket strainers prevent scraps of food from clogging your plumbing. For sanitation, the coved corners of the sink bowls allow for fast and easy cleaning.

This sink comes with a 12" drainboard on either side to help dry wet dishes, and the backsplash is 10 3/4" tall to keep your walls dry. A 2 1/2" raised rolled edge helps contain splashes and overflow, and thanks to its 1 5/8" diameter galvanized steel legs with galvanized sockets, you can be sure this unit will remain sturdy throughout the day. Adjustable plastic bullet feet allow you to level the sink on uneven flooring for sure stability. Precut holes are drilled into the backsplash on 8" centers for your wall-mounted faucet (sold separately).

⚠ WARNING: This product can expose you to chemicals including Lead and Nickel, which are known to the State of California to cause cancer and birth defects or other reproductive harm. For more information, go to www.p65warnings.ca.gov.