

REGENCY
Tables and Sinks

Regency 60" 16-Gauge Stainless Steel Two Compartment Commercial Utility Sink - 30" x 24" x 14" Bowl

#600S23024SB



Technical Data

Length	60 Inches
Width	27 1/2 Inches
Height	41 Inches
Bowl Depth	14 Inches
Backsplash Height	8 3/4 Inches
Work Surface Height	33 Inches
Bowl Front to Back	24 Inches
Bowl Left to Right	30 Inches
Faucet Centers	8 Inches
Features	Massachusetts Accepted Plumbing Product

Features

- Constructed of corrosion-resistant 16-gauge, type 304 stainless steel
- Galvanized steel legs and adjustable bullet feet provide stability
- Deep bowl accommodates large items
- Accepts wall-mounted faucets on 8" centers (sold separately)
- Ideal for a variety of janitorial or commercial kitchen applications

Technical Data

Gauge	16 Gauge
Installation Type	Freestanding
Leg Construction	Galvanized Steel
Material	Stainless Steel
Number of Compartments	2 Compartments
Stainless Steel Type	Type 304

Plan View

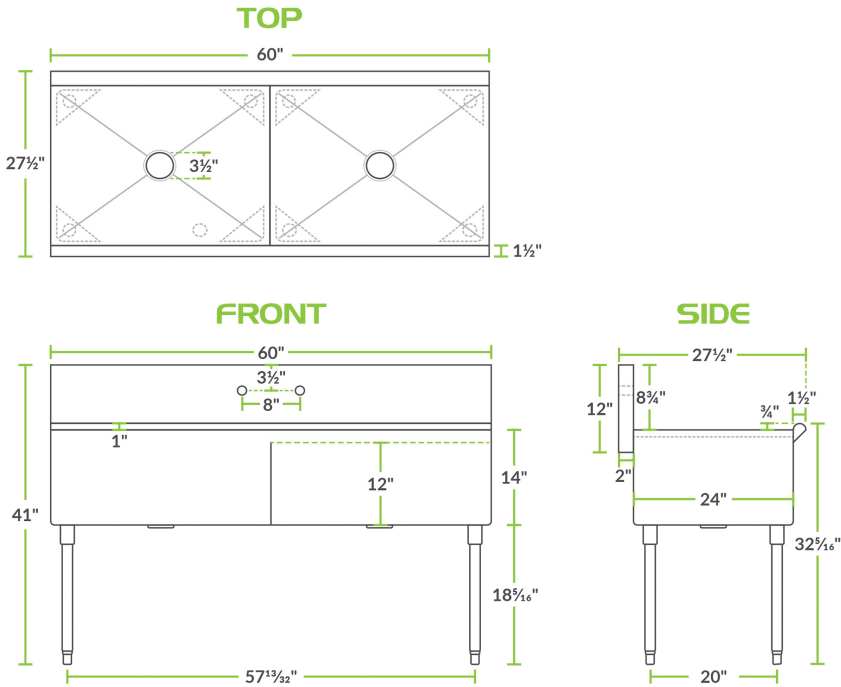

Notes & Details

This Regency 60" 16-gauge stainless steel two compartment commercial utility sink is a great economical choice for an array of establishments. It's constructed from sturdy, 16-gauge type 304 stainless steel, making it more corrosion-resistant and durable than other sinks made from thinner, 18-gauge material. It also boasts two 14" deep bowls perfect for accommodating larger items such as mop buckets. A 1 1/2" IPS drain and a convenient strainer basket come standard with this unit.

With two compartments, you can utilize the space in your kitchen to create an efficient workflow. An 8 3/4" tall backsplash is included to protect your walls and it comes complete with two holes punched on 8" centers for a wall-mounted faucet (sold separately). The legs are constructed of galvanized steel with bullet feet with 1" of adjustability so you can install this sink to best fit your needs. This unit is ideal for a variety of janitorial and commercial kitchen applications.

⚠️ WARNING: This product can expose you to chemicals including lead, which are known to the State of California to cause cancer, birth defects, or other reproductive harm. For more information, go to www.p65warnings.ca.gov.