



## Regency 43" 16 Gauge Stainless Steel Two Compartment Commercial Sink with Stainless Steel Legs and Cross Bracing - 18" x 24" x 14" Bowls

#600S21824X



### Technical Data

Length	43 Inches
Width	29 1/2 Inches
Height	43 3/4 Inches
Bowl Depth	14 Inches
Backsplash Height	9 Inches
Basket Drain Size	3 1/2 Inches
Bowl Front to Back	24 Inches
Bowl Left to Right	18 Inches
Drain Outlet Size	1 1/2 Inches
Faucet Centers	8 Inches

### Features

- 16-gauge type 304 stainless steel construction
- Designed with (2) 14" deep bowls and rounded corners for easy cleaning
- Stainless steel legs, sockets, bullet feet, and crossbracing for maximum strength and longevity
- Includes two 3 1/2" drain baskets
- Rolled edge contains splashes and overflow

### Certifications



## Technical Data

Features	NSF Listed
Gauge	16 Gauge
Leg Construction	Stainless Steel
Material	Stainless Steel
Number of Compartments	2 Compartments
Number of Drainboards	None
Stainless Steel Type	Type 304
Style	0 Drainboards
Type	Straight / Line Sinks

## Plan View

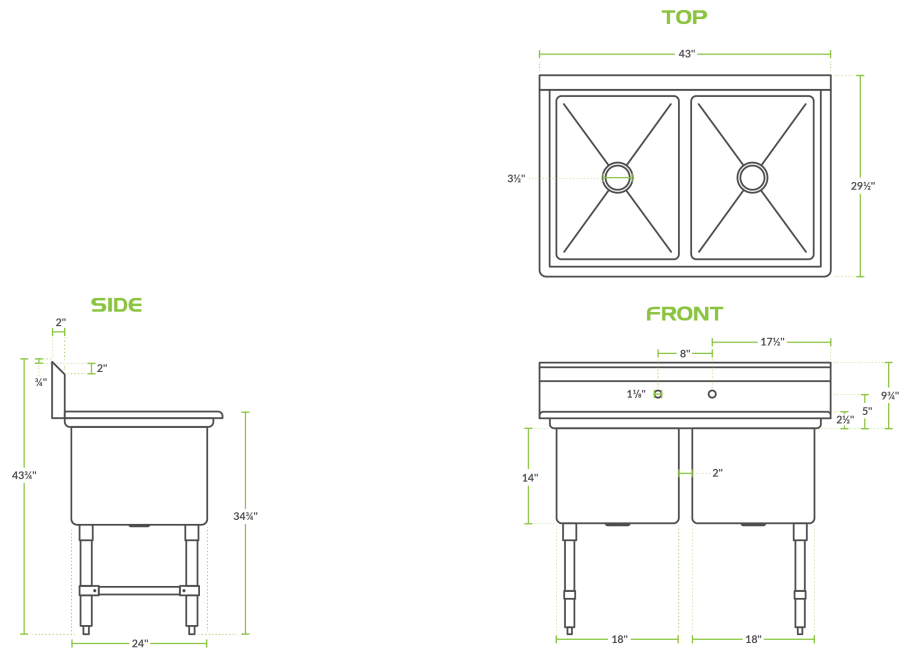

## Notes & Details

Outfit your facility with a long-lasting sink with this Regency 43" stainless steel two compartment sink. It's constructed from high-quality, 16-gauge type 304 stainless steel, making it more corrosion-resistant and durable than other sinks made from thinner, 18-gauge type 430 stainless steel. It's dipped a minimum of 1/4" to facilitate better drainage, and the welded construction contributes to the long-lasting use and overall strength of this sink.

The 14" deep bowls are die-stamped to a minimum of 1/4" to ensure proper drainage. Plus, each bowl includes a 3 1/2" basket strainer to catch food debris, which prevents the drain from clogging. For easy cleaning, each compartment has rounded corners so you can rinse and wipe down the sink.

A 9" tall backsplash is included and comes complete with (2) 1 1/8" diameter holes punched on 8" centers to accommodate 1 faucet (sold separately). This sink also includes a 1 1/2" raised rolled edge, which is 2" tall on the front and both sides to contain splashes and overflow. The legs are constructed of 1 5/8" diameter stainless steel with stainless steel cross-bracing and adjustable plastic feet for added stability. These features serve to prolong the life of your sink while adding exceptional strength to the unit.

**WARNING:** This product can expose you to chemicals including lead, which are known to the State of California to cause cancer, birth defects, or other reproductive harm. For more information, go to [www.p65warnings.ca.gov](http://www.p65warnings.ca.gov).