

REGENCY
Tables and Sinks

Regency 21" x 42" Underbar Ice Bin with 10 Circuit Post-Mix Cold Plate and Bottle Holders

#600IB2142C0



Technical Data

Length	42 Inches
Width	21 Inches
Height	33 Inches
Ice Bin Length	40 Inches
Ice Bin Width	15 3/16 Inches
Ice Bin Depth	8 Inches
Backsplash Height	3 Inches
Work Surface Height	30 Inches
Capacity	93 lb.
Color	Silver

Features

- 20 gauge stainless steel bin; 93 lb. capacity
- Galvanized steel legs with adjustable plastic bullet feet
- Circuit post-mix cold plate chills up to 10 different beverage lines
- 2 plastic bottle holders and a 3" backsplash limits messes
- 5/8" I.D. drain

Certifications



Technical Data

Features	Bottle Storage NSF Listed With Backsplash
Installation Type	Freestanding
Leg Construction	Galvanized Steel
Material	Stainless Steel
Number of Cold Plate Circuits	10 Circuits
Type	Ice Bins With Cold Plate

Plan View

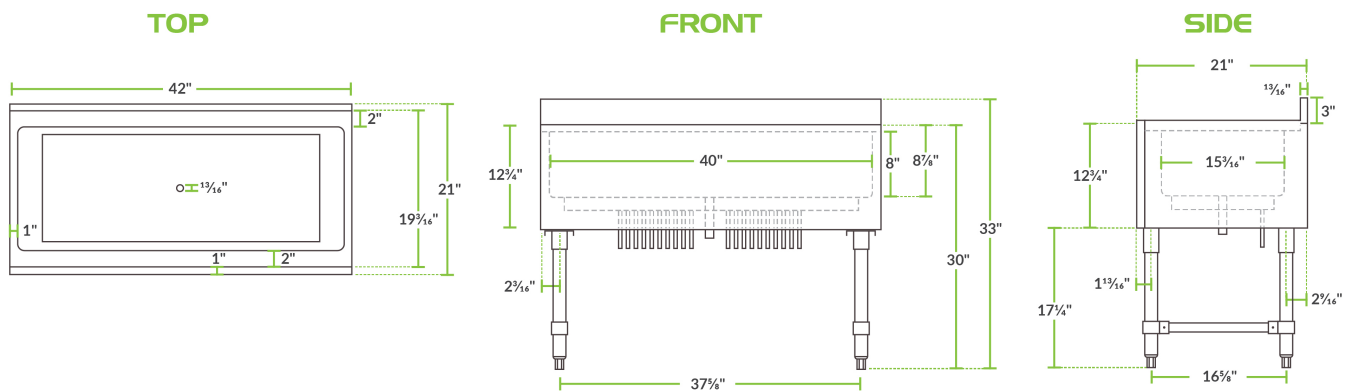

Notes & Details

Whether you're serving up a delicious cocktail or a refreshing soda, ensure you have a steady supply of cold beverages at your bar thanks to this Regency 21" x 42" underbar ice bin with 10 circuit cold plate! This convenient unit not only holds plenty of ice but also boasts a post-mix cold plate with stainless steel, beverage-grade tubing circuits that allow you to run up to 10 soda lines through the bin to chill them before serving. The 15 3/16" x 40" interior bowl holds ice, while two plastic bottle holders with removable dividers let you simultaneously chill your most popular liquors and mixers. A 1" I.D. drain pipe safely drains melted ice water from the unit so you're only left with solid pieces.

This Regency ice bin is constructed of 20 gauge, type 304 stainless steel and features poly foam insulation to help keep the bin's contents cooler longer. It stands on four galvanized legs with adjustable plastic bullet feet for stability. It also boasts a backslash to help keep your walls and floors dry. Thanks to this unit's versatility, it's easy to store and chill everything you need to create the perfect gin and tonic, whiskey ginger, cranberry vodka, and other popular drinks at your busy bar, nightclub, or restaurant.

WARNING: This product can expose you to chemicals including lead, which are known to the State of California to cause cancer, birth defects, or other reproductive harm. For more information, go to www.p65warnings.ca.gov.