

REGENCY
Tables and Sinks

Regency 96" x 17 1/2" Single-Hole Multi-Station Hand Sink with 4 Hands-Free Sensor Faucets

#600HSMSE1896



Technical Data

Length	96 Inches
Width	17 1/2 Inches
Height	18 Inches
Spout Length	6 3/16 Inches
Bowl Depth	8 Inches
Backsplash Height	10 Inches
Faucet Height	11 1/16 Inches
Spout Height	11 1/8 Inches
Basket Drain Size	3 1/2 Inches
Bowl Front to Back	13 3/4 Inches

Features

- Rugged 16 gauge type 304 stainless steel sink and solid chrome-plated brass faucet built for long life
- Sink punched with 4 sets of single-holes for wall mounted faucets
- Faucet designed with 6 3/16" gooseneck spout, 2.2 GPM flow rate
- Brackets, mixing valve, supply lines, and elbows provided for easy installation
- Package includes multi-station hand sink and hands-free sensor faucet

Certifications



1-15P



3/8" Water Connection



1/2" Water Connection

Technical Data

Bowl Left to Right	96 Inches
Color	Silver
Faucet Centers	Single
Features	Faucet Included Flex Inlets Included Hands Free Multi-Station
Flow Rate	2.2 GPM
Gauge	16 Gauge
Installation Type	Wall Mounted
Material	Stainless Steel
Number of Compartments	1 Compartment
Number of Drainboards	None
Number of Faucets	4 Faucets
Plug Type	NEMA 1-15P
Spout Clearance	6 5/8 Inches
Spout Type	Gooseneck
Stainless Steel Type	Type 304
Type	Hand Sinks
Water Inlet Size	1/2 Inches 3/8 Inches

Plan View

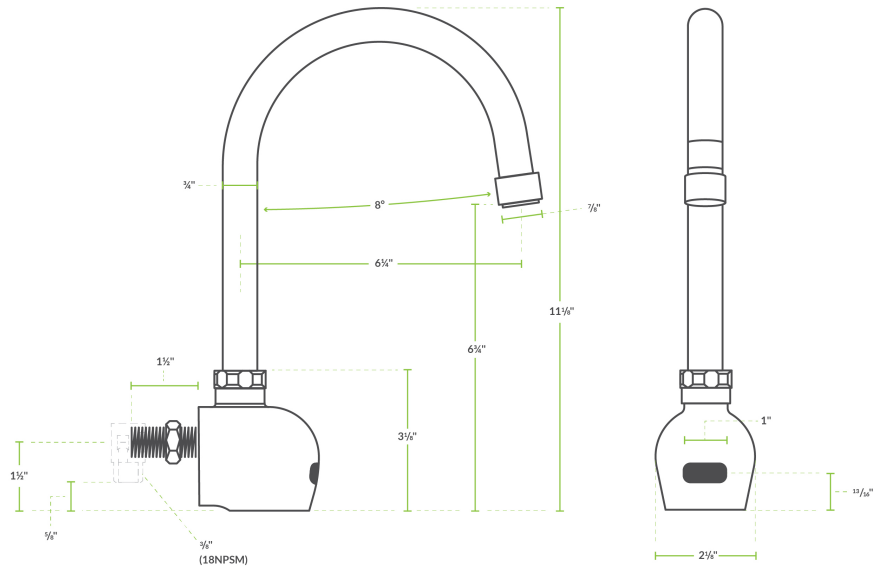
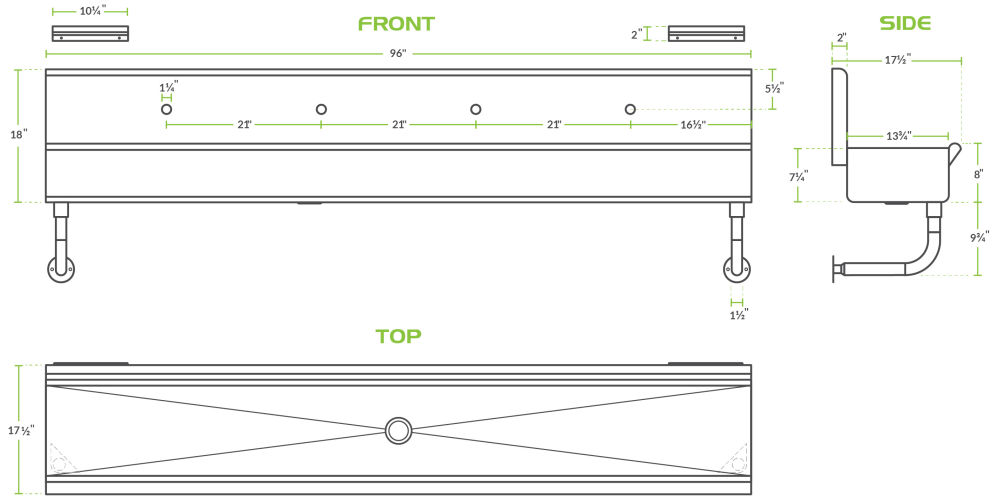

Notes & Details

Maintain a sanitary environment in your auto garage, distribution center, or manufacturing facility by giving your employees a convenient way to quickly wash their hands with this Regency multi-station hand sink with hands-free sensor faucet! Made of rugged 16 gauge type 304 stainless steel, the sink is not only rust- and corrosion-resistant, it's extremely durable and built for everyday commercial use. This wall mounted sink station includes 4 sets of holes for single-hole faucets. The spacious 8" deep sink bowl is designed to accommodate multiple users for handwashing applications, making it so employees don't have to wait their turn to clean up.

For ease of use on day one, this package includes 4 Waterloo EFWM wall-mounted hands-free sensor faucets that feature 6 3/16" high gooseneck spouts on single hole bases to provide a contemporary and refined look wherever they're installed. Because a sensor activates the water flow, the faucets have several advantages over traditional handle-style faucets. They are hands-free, which reduces the opportunity for germs to spread, and also prevents the faucets from running when not needed, which helps to cut down on your water bill. A mixing valve also allows you to easily set the output temperature to the desired level. This prevents burned hands from water that is too hot, while still ensuring that the water is warm enough for users to effectively wash their hands. As an added bonus, these sensor faucets are NSF61 / 372 compliant.

Designed for wall mounting, the sink comes with (2) 1 5/8" tubular wall brackets and 2 stainless steel Z brackets. A 10" high back splash protects your walls from splashing and water damage, and a 3 1/2" drain basket keeps your drains clog-free. For faucet installation, an AC adapter is provided to power the faucet's control module, which installs below the countertop and connects to the faucet with an elbow and a 30" flexible supply line. You can also use (4) AA batteries if an outlet isn't convenient, and to provide backup power in case of an outage. A pair of 18" flexible stainless steel connectors with 1/2" NPSM female x 3/8" female compression fittings connect the mixing valve to your building's water lines.

Kit Includes:

- (1) Regency 96" x 17 1/2" single-hole multi-station hand sink for 4 wall mounted faucets
- (4) Waterloo EFWM wall-mounted hands-free sensor faucets with 6 3/16" gooseneck spouts

 **WARNING:** This product can expose you to chemicals including lead, which are known to the State of California to cause cancer, birth defects, or other reproductive harm. For more information, go to www.p65warnings.ca.gov.