



Regency 10" x 36" Stainless Steel Adjustable Work Surface for 36" Long Equipment Stands

#600ESSCB36



Technical Data

Length	36 Inches
Width	10 Inches
Features	NSF Listed
Gauge	16 Gauge
Material	Stainless Steel
Stainless Steel Type	Type 304
Type	Work Surfaces

Features

- Strong 16 gauge type 304 stainless steel surface with hat channel
- Adds a convenient work surface to 36" long equipment stands
- Mounts to equipment stand with curved, stainless steel legs and welded sockets
- Adjustable height
- Easy to install

Certifications



Plan View

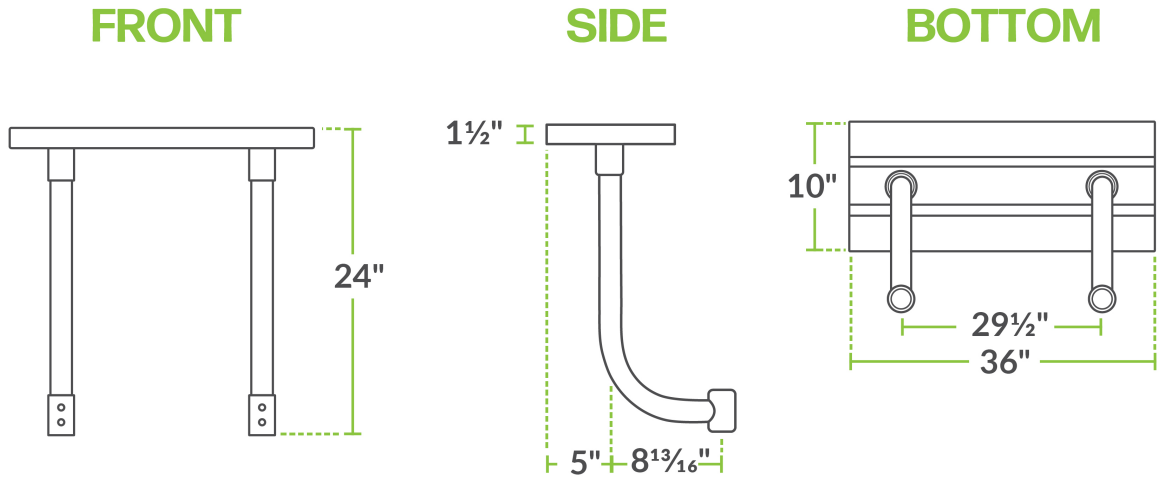

Notes & Details

This Regency stainless steel adjustable work surface is the perfect addition to your equipment stand. It provides a convenient, durable, easy-to-clean surface for placing ingredients or assembling sides! It adds versatility to your equipment stand to maximize space. Plus, because it's made of 16 gauge type 304 stainless steel, it's sturdy and long-lasting and won't dull knives.

Two stainless steel, curved legs attach the board to your 36" long equipment stand, and two stainless steel welded sockets hold it in place. This method of installation allows the work surface to easily adjust in height; just raise or lower where the sockets screw onto the equipment stand. Hardware sold separately.

⚠ WARNING: This product can expose you to chemicals including lead, which are known to the State of California to cause cancer, birth defects, or other reproductive harm. For more information, go to www.p65warnings.ca.gov.