



Regency 10" x 96" Stainless Steel Plate Shelf for 96" Long Equipment Stands

#600ESCBPS96



Technical Data

Length	96 Inches
Width	10 Inches
Features	NSF Listed
Material	Stainless Steel
Type	Shelves

Features

- Provides extra storage for plates, utensils, and other items
- Must be used with a 10" x 96" equipment stand cutting board or work surface
- Easy to install

Certifications



Plan View

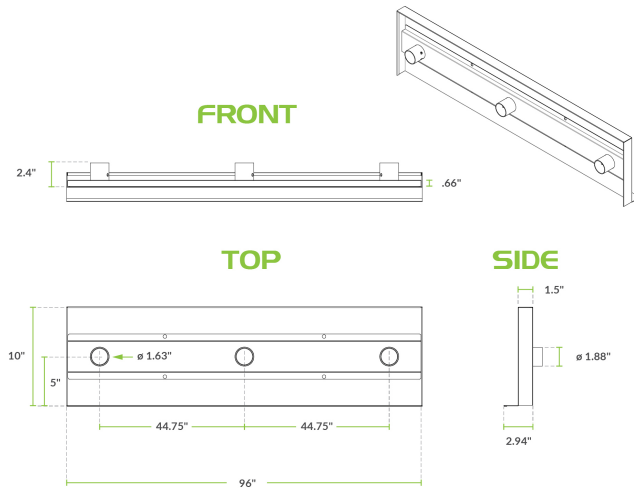

Notes & Details

This Regency 10" x 96" stainless steel plate shelf is an excellent way to increase the versatility of your 96" equipment stand! When mounted onto the supports of a 10" x 96" equipment stand cutting board or work surface, this shelf provides extra storage space for plates, utensils, and other commonly used items that you want to keep close to your work area. It is made from stainless steel to provide durability in fast-paced kitchens, and has a backsplash to keep items from falling off of the shelf.

⚠ WARNING: This product can expose you to chemicals including lead, which are known to the State of California to cause cancer, birth defects, or other reproductive harm. For more information, go to www.p65warnings.ca.gov.