



Regency 30" x 36" 16 Gauge Type 304 Stainless Steel Enclosed Base Sliding Door Table with Adjustable Midshelf and 6" Backsplash

#600EBTB3036D



Technical Data

Length	36 Inches
Width	30 Inches
Height	42 Inches
Backsplash Height	6 Inches
Work Surface Height	36 Inches
Backsplash	With Backsplash
Door Style	Sliding
Features	NSF Listed
Gauge	16 Gauge
Number of Doors	2 Doors

Features

- Durable 18 gauge type 430 stainless steel body with 16 gauge type 304 stainless top
- Enclosed style body provides concealed storage
- Adjustable/removable stainless steel midshelf maximizes storage capacity
- Two sliding doors include recessed handles
- A 6" backsplash prevents messes from getting onto the wall

Certifications



Technical Data

Size	30" x 36"
Stainless Steel Type	Type 304
Table Style	Enclosed Base
Tabletop Material	Stainless Steel
Top Capacity	630 lb.

Plan View

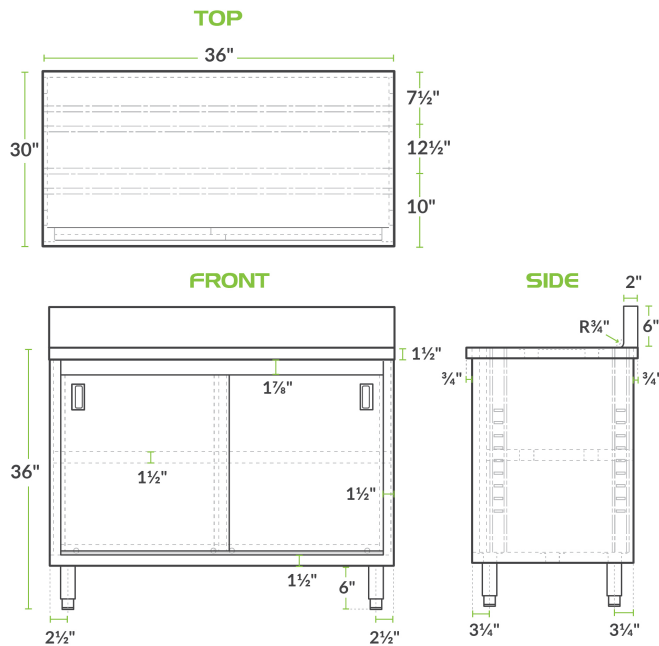

Notes & Details

With both ample work space as well as storage space, this Regency 30" x 36" 16 gauge type 304 stainless steel enclosed base table will ensure your establishment is efficient and organized! A large 30" x 36" worktop will give you plenty of room to operate and is made of durable 16 gauge type 304 stainless steel. Plus, with a body made of 18 gauge type 430 stainless steel, this enclosed base table is made to hold up to the wear and tear of the busiest kitchens.

The adjustable/removable midshelf allows you to maximize the storage space and fit both large as well as small items. A 6" backsplash prevents any messes from getting onto the wall behind the unit, helping make cleanup easier. The sliding doors fully conceal the base's contents and include recessed handles for minimal required front clearance. In order to keep your items secure, the doors come with built-in locks, as well as a set of keys. Bullet style feet easily adjust up and down so that your base can be leveled on uneven surfaces.

⚠️ WARNING: This product can expose you to chemicals including lead, which are known to the State of California to cause cancer, birth defects, or other reproductive harm. For more information, go to www.p65warnings.ca.gov.