



## Regency 24" x 60" 16 Gauge Type 304 Stainless Steel Enclosed Base Open Front Table with Adjustable Midshelf and 6" Backsplash

#600EBTB2460



### Technical Data

Length	60 Inches
Width	24 Inches
Height	42 Inches
Backsplash Height	6 Inches
Work Surface Height	36 Inches
Backsplash	With Backsplash
Door Style	None
Features	NSF Listed
Gauge	16 Gauge
Size	24" x 60"

### Features

- Durable 18 gauge type 430 stainless steel body with 16 gauge type 304 stainless top
- Open front allows for quicker and easier access to supplies
- Adjustable/removable stainless steel midshelf maximizes storage capacity
- Large 24" x 60" worktop for plenty of working room
- A 6" backsplash prevents messes from getting onto the wall

### Certifications



## Technical Data

Stainless Steel Type	Type 304
Table Style	Enclosed Base
Tabletop Material	Stainless Steel
Top Capacity	680 lb.

## Plan View

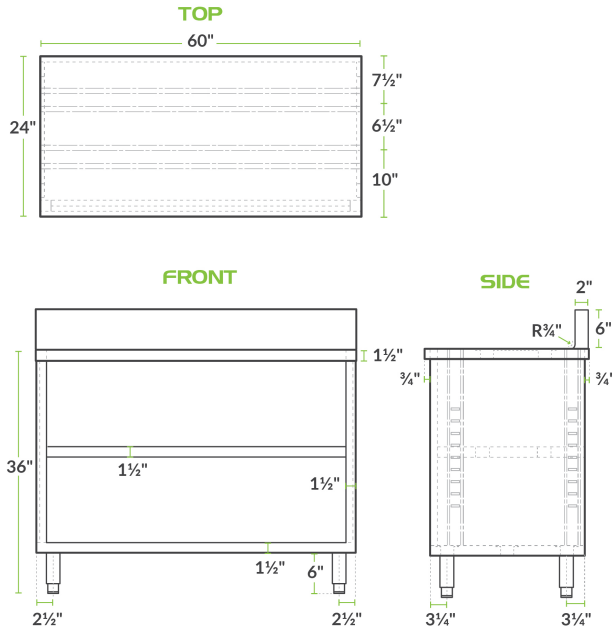

## Notes & Details

With both ample work space as well as storage space, this Regency 24" x 60" 16 gauge type 304 stainless steel enclosed base table will ensure your establishment is efficient and organized! A large 24" x 60" worktop will give you plenty of room to operate and is made of durable 16 gauge type 304 stainless steel. Plus, with a body made of 18 gauge type 430 stainless steel, this enclosed base table is made to hold up to the wear and tear of the busiest kitchens.

The adjustable/removable midshelf allows you to maximize the storage space and fit both large as well as small items. A 6" backsplash prevents any messes from getting onto the wall behind the unit, helping make cleanup easier. The open front design provides quick identification for quicker and easier access to supplies. Bullet style feet easily adjust up and down so that your base can be leveled on uneven surfaces.

**⚠️ WARNING:** This product can expose you to chemicals including lead, which are known to the State of California to cause cancer, birth defects, or other reproductive harm. For more information, go to [www.p65warnings.ca.gov](http://www.p65warnings.ca.gov).