

REGENCY
Tables and Sinks

Regency 20" x 20" x 5" Drawer with Stainless Steel Front

#600DR2020



Technical Data

Length	25 1/8 Inches
Width	24 Inches
Height	6 7/8 Inches
Drawer Insert Length	20 Inches
Interior Length	20 Inches
Drawer Insert Width	20 Inches
Interior Width	19 1/2 Inches
Drawer Insert Height	5 Inches
Interior Height	5 Inches
Color	Silver

Features

- Features a removable insert for easy cleanup
- Smooth operation thanks to ball-bearing slides
- Durable stainless steel and galvanized steel construction
- Easy to install with the included pre-drilled Z brackets; can be stacked up to 2 or 3 drawers high
- Works with 24", 30", and 36" deep Regency tables that are at least 36" long

Certifications



Technical Data

Features	NSF Listed
Material	Galvanized Steel Stainless Steel
Number of Drawers	1 Drawers
Stainless Steel Type	Type 304
Type	Drawers

Plan View

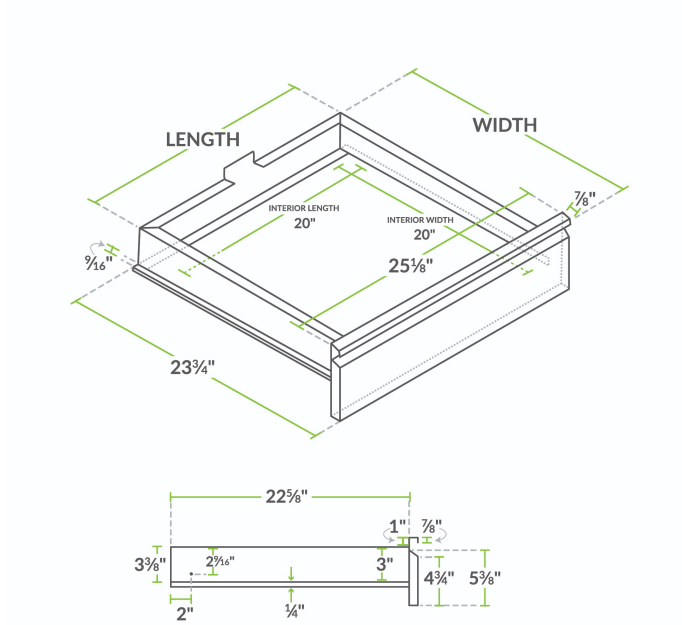

Notes & Details

Keep your kitchen organized by mounting this Regency Tables and Sinks 20" x 20" x 5" galvanized steel drawer to the hat channels under your work table. Each drawer features an easy-to-clean stainless steel front and moves on ball-bearing sides. The drawer pan is made of 22 gauge, type 304 stainless steel.

Installation is easy thanks to the pre-drilled Z-brackets - simply drill through the table's hat channels and secure the drawer with screws. The drawer can also stack up to 3 high if you need to add more storage down the road - to add a drawer, drill into the bottom of the top drawer's frame, and use screws to mount the lower drawer.

This drawer is compatible with all 24", 30", and 36" deep Regency tables that are at least 36" long. It includes the screws and hex nuts necessary to either mount the Z-brackets to the table, or to attach it to the bottom of another drawer.

WARNING: This product can expose you to chemicals including lead, which are known to the State of California to cause cancer, birth defects, or other reproductive harm. For more information, go to www.p65warnings.ca.gov.