



Regency 9 3/8" x 11 3/4" x 5" 22-Gauge Stainless Steel One Compartment Drop-in Sink

#600DIS1012



Technical Data

Length	12 3/8 Inches
Width	14 3/4 Inches
Height	5 Inches
Bowl Depth	5 Inches
Bowl Front to Back	11 3/4 Inches
Bowl Left to Right	9 3/8 Inches
Color	Silver
Drain Opening	2 Inches
Edge Style	Flush
Gauge	22 Gauge

Features

- Seamless deep drawn sink bowl for easy cleaning
- Innovative self rim design allows flush mounting into any countertop
- 9 3/8" x 11 3/4" x 5" bowl size
- Durable 22-gauge, type 304 stainless steel construction
- Includes drain connection for easy installation

Certifications



Technical Data

Features	Massachusetts Accepted Plumbing Product NSF Listed
Installation Type	Drop In
Material	Stainless Steel
Number of Compartments	1 Compartment
Stainless Steel Type	Type 304
Type	Drop-In Sinks

Plan View

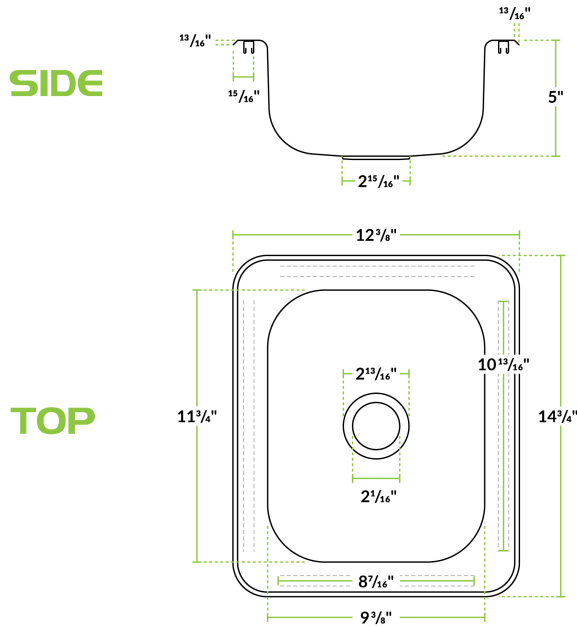

Notes & Details

Equip your kitchen, prep area, or bar with this Regency 9 3/8" x 11 3/4" x 5" 22-gauge stainless steel one compartment drop-in sink. This sink features a drop-in design that fits down through the top of your counter. It has an innovative self rim feature along the top to provide a professional appearance once it's installed into any countertop.

Designed for durability, corrosion-resistance, and sanitation, this sink's bowl is made of seamless deep drawn 22-gauge, type 304 stainless steel. Plus, the 2" drain opening is ready for installation so you can get your new sink up and running. Simply mount your sink in front a faucet for the perfect handwashing station or dump sink in your establishment.

⚠️ WARNING: This product can expose you to chemicals including lead, which are known to the State of California to cause cancer, birth defects, or other reproductive harm. For more information, go to www.p65warnings.ca.gov.