



Regency 18" x 48" 18 Gauge Type 304 Stainless Steel Dish Cabinet with Adjustable Midshelf

#600DC1848



Technical Data

Length	48 Inches
Width	18 Inches
Height	36 Inches
Cabinet Type	Open
Gauge	18 Gauge
Material	Stainless Steel
Top Capacity	400 lb.

Features

- 18 gauge type 304 stainless steel top
- Adjustable/removable stainless steel midshelf
- Bullet style feet are adjustable to ensure cabinet is level
- Open style design allows for quick and easy access
- Shallow 18" width requires minimal floor space

Plan View

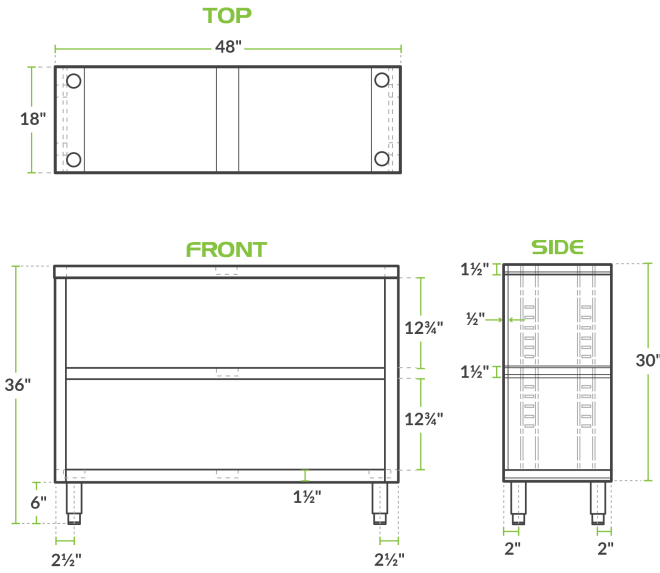

Notes & Details

Keep your dishes, flatware, and glassware hidden and out of harm's way with this Regency 18" x 48" stainless steel dish cabinet. Constructed of 18 gauge type 304 stainless steel, this cabinet is built tough to withstand the wear and tear of a busy commercial kitchen. The 48" long top provides plenty of space for staging clean plates and other tableware that is ready for table service, while the shallow 18" width takes up minimal walking space in the kitchen.

An adjustable shelf can be placed at different heights to accommodate an endless amount of different storage configurations. It can also be completely removed, making it an option for taller items if necessary. This cabinet has an open design, without doors, so that its contents are more easily and quickly accessed without any obstacles. Each leg has an adjustable bullet style foot that can be raised or lowered to level the cabinet if the floor is uneven.

⚠ WARNING: This product can expose you to chemicals including lead, which are known to the State of California to cause cancer, birth defects, or other reproductive harm. For more information, go to www.p65warnings.ca.gov.