



Regency Spec Line 20" x 20" x 5" Self Closing Drawer with Stainless Steel Front and Locks

#600DR2020LK



Technical Data

Length	25 1/8 Inches
Width	24 Inches
Height	6 7/8 Inches
Drawer Insert Length	20 Inches
Interior Length	20 Inches
Drawer Insert Width	20 Inches
Interior Width	19 1/2 Inches
Drawer Insert Height	5 Inches
Interior Height	5 Inches
Features	NSF Listed

Features

- Features a removable insert for easy cleanup
- Self-closing design is quiet, prevents slamming, and improves drawer life
- Durable stainless steel and galvanized steel construction
- Easy to install with the included Z brackets; can be stacked up to 2 or 3 drawers high
- Works with 24", 30", and 36" deep Regency tables that are at least 36" long

Certifications



Technical Data

Gauge	18 - 22 Gauge
Material	Galvanized Steel Stainless Steel
Number of Drawers	1 Drawers
Stainless Steel Type	Type 304 Type 430
Type	Drawers

Plan View

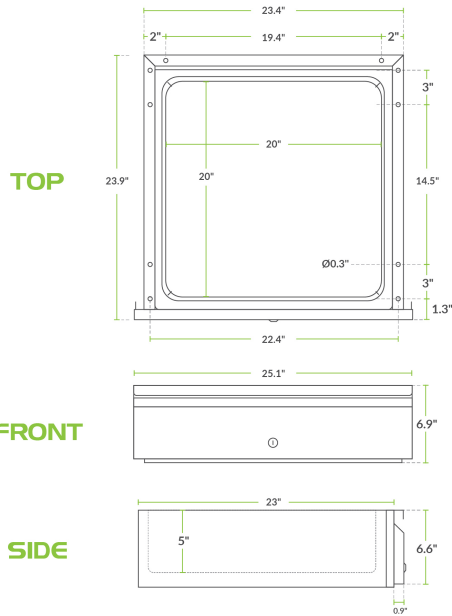

Notes & Details

Keep your kitchen organized by mounting this Regency Spec Line Tables and Sinks 20" x 20" x 5" galvanized steel drawer to the hat channels under your work table. Each drawer features an easy-to-clean stainless steel front and utilizes self-closing ball-bearing slides. This upgraded feature makes the drawer quieter and easier to close, while also preventing slamming that can lead to staff injury or damage to the slide components. The drawer pan is made of 22 gauge, type 304 stainless steel. They also have built-in locks, allowing you to secure the drawer's contents with ease for added security.

Installation is easy thanks to the pre-drilled Z-brackets - simply drill through the table's hat channels and secure the drawer with screws. The drawer can also stack up to 3 high if you need to add more storage down the road - to add a drawer, drill into the bottom of the top drawer's frame, and use screws to mount the lower drawer.

This drawer is compatible with all 24", 30", and 36" deep Regency Spec Line tables that are at least 36" long. It includes the screws and hex nuts necessary to either mount the Z-brackets to the table, or to attach it to the bottom of another drawer.

⚠ WARNING: This product can expose you to chemicals including lead, which are known to the State of California to cause cancer, birth defects, or other reproductive harm. For more information, go to www.p65warnings.ca.gov.