



Regency 16-Gauge Type 304 Stainless Steel Pass-Through Shelf with Overshelf - 18" x 48"

#600PTSD1848



Technical Data

Length	48 Inches
Width	18 Inches
Height	14 Inches
Capacity	400 lb.
Color	Silver
Features	NSF Listed Overshelf
Gauge	16 Gauge
Material	Stainless Steel
Number of Shelves	2 Shelves

Features

- Provides a convenient place for servers to pick up orders
- 18" x 48" size provides plenty of space for plates, bowls, and trays
- Made of durable type 304, 16-gauge stainless steel
- Includes mounting brackets for installation
- Resistant to corrosion and rust

Certifications



Technical Data

Stainless Steel Type	Type 304
Style	Pass-Through
Type	Shelves

Plan View

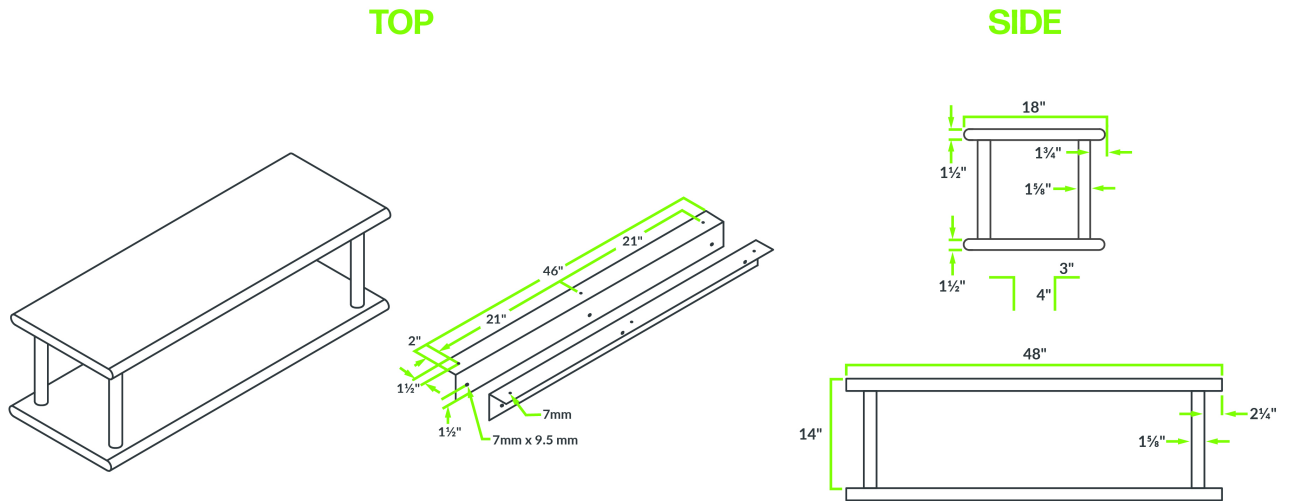

600PTSD1848

Notes & Details

This Regency 18" x 48" pass-through shelf provides a convenient place for servers to pick up their orders! Since this shelf comes with both a pass-through shelf and an overshell, it offers twice the amount of surface area where plates of hot food can be placed for pickup. Because it is made of 16-gauge type 304 stainless steel that makes it exceptionally resistant to corrosion, this shelf can be confidently installed in your kitchen without fear of rust or corrosion. The solid, flat surface is 18" wide, ensuring your dishes, bowls, and trays will fit on the shelf securely.

This pass-through shelf is made of durable type 304, 16-gauge stainless steel for the shelf and features a 1 1/2" sanitary rolled front and back edges with square ends. As a result, it makes for a reliable, long-lasting storage solution perfect for business applications. The classic stainless steel finish on this shelf and its sleek design makes it an excellent option for your restaurant, ensuring that it will blend in with any decor. Designed for a wall that is 10 1/2" thick or less, this shelf includes 2 L-shaped brackets to simplify installation and allow you to install the shelf where you want it. All other mounting hardware is sold separately.

⚠ WARNING: This product can expose you to chemicals including lead, which are known to the State of California to cause cancer, birth defects, or other reproductive harm. For more information, go to www.p65warnings.ca.gov.