



Regency 16-Gauge Type 304 Stainless Steel Pass-Through Shelf - 24" x 96"

#600PTS2496



Technical Data

Length	96 Inches
Width	24 Inches
Height	1 1/2 Inches
Capacity	780 lb.
Color	Silver
Features	NSF Listed
Gauge	16 Gauge
Material	Stainless Steel
Number of Shelves	1 Shelf

Features

- Provides a convenient place for servers to pick up orders
- 24" x 96" size provides plenty of space for plates, bowls, and trays
- Made of durable type 304, 16-gauge stainless steel
- Includes mounting brackets for installation
- Resistant to corrosion and rust

Certifications



Technical Data

Stainless Steel Type	Type 304
Style	Pass-Through
Type	Shelves

Plan View

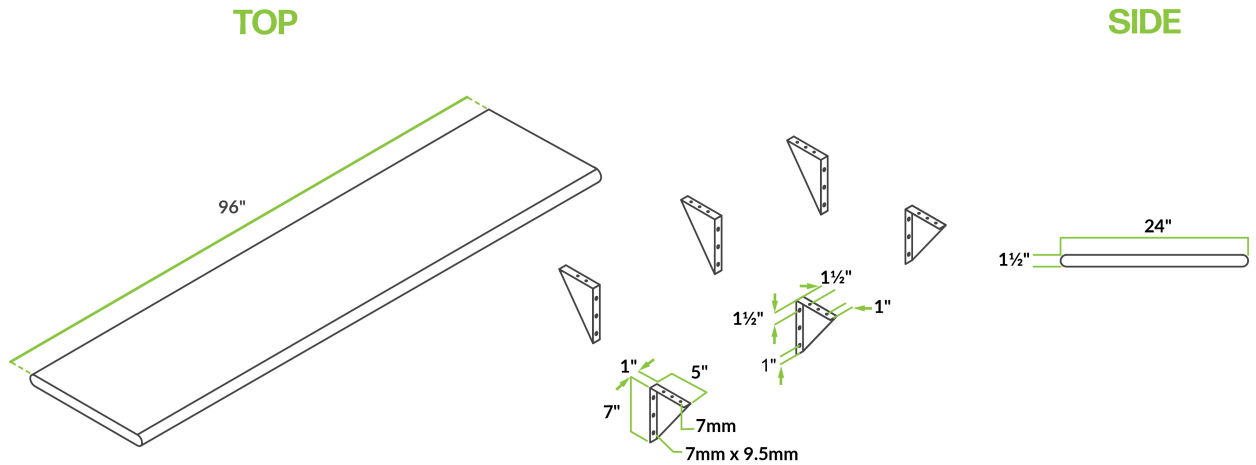

600PTS2496

Notes & Details

This Regency 24" x 96" pass-through shelf provides a convenient place for servers to pick up their orders! Because it is made of 16-gauge type 304 stainless steel that makes it exceptionally resistant to corrosion, this shelf can be confidently installed in your kitchen without fear of rust or corrosion. The solid, flat surface is 24" wide, ensuring your dishes, bowls, and trays will fit on the shelf securely.

This pass-through shelf is made of durable type 304, 16-gauge stainless steel for the shelf and features a 1 1/2" sanitary rolled front and back edges with square ends. As a result, it makes for a reliable, long-lasting storage solution perfect for business applications. The classic stainless steel finish on this shelf and its sleek design makes it an excellent option for your restaurant, ensuring that it will blend in with any decor. Designed for a wall that is 12 1/2" thick or less, this shelf includes 6 cantilever brackets to simplify installation and allow you to install the shelf where you want it. For added convenience, the hardware is included to mount the brackets to the shelf. The wall mounting hardware is sold separately.

⚠ WARNING: This product can expose you to chemicals including lead, which are known to the State of California to cause cancer, birth defects, or other reproductive harm. For more information, go to www.p65warnings.ca.gov.