



Regency 60" x 24" x 8" Aluminum Dunnage Rack - 1850 lb. Capacity

#600DUN24608



Technical Data

Length	60 Inches
Width	24 Inches
Height	8 Inches
Capacity	1850 lb.
Capacity Rating	Medium Duty
Casters	Without Casters
Color	Silver
Features	NSF Listed
Material	Aluminum

Features

- Perfect for use in coolers and freezers
- 1850 lb. capacity
- Heavy-duty aluminum construction
- Keeps product organized and off the floor
- Promotes air circulation to prolong product life

Certifications



Technical Data

Rack Style	Stationary
Type	Racks
Usage	Heavy Duty

Plan View

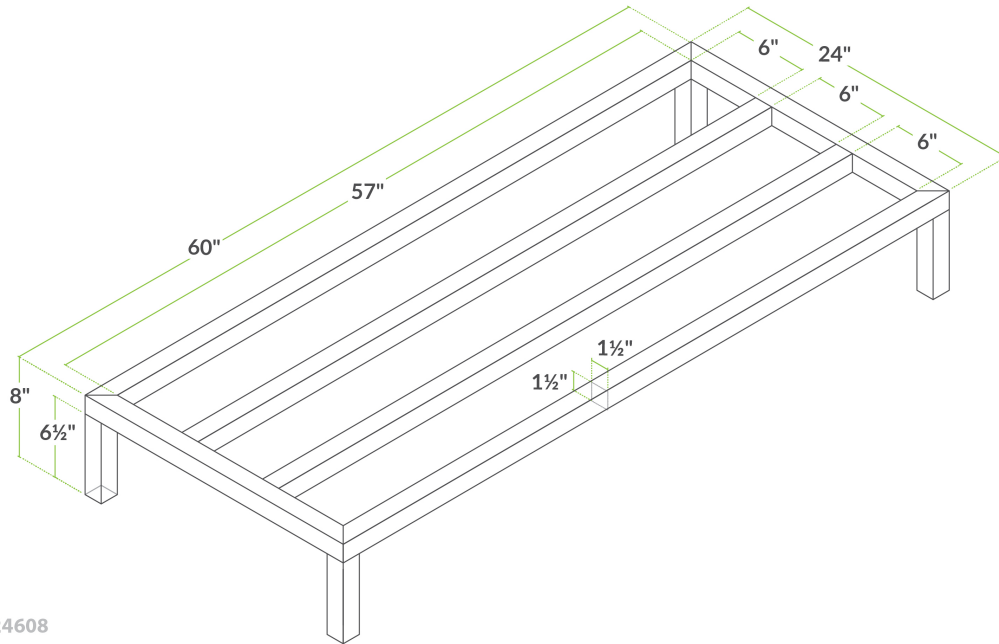

600DUN24608

Notes & Details

Keep large items stored off the floor with this 60" x 24" x 8" aluminum dunnage rack. Constructed of heavy duty tubular welded aluminum, this dunnage rack is ready for any environment.

Its aluminum tubes are welded to the frame horizontally on 4 1/2" centers for a sturdy storage surface. The legs are mitered, with plastic feet to help protect your floors.

Ideal for coolers and freezers, as well as the selling floor, avoid damage from foot traffic and unsanitary conditions with the 60" x 24" x 8" aluminum dunnage rack.

⚠ WARNING: This product can expose you to chemicals including lead, which are known to the State of California to cause cancer, birth defects, or other reproductive harm. For more information, go to www.p65warnings.ca.gov.