



Regency 1.15 GPM Deck-Mounted Pre-Rinse Faucet with 4" Centers and 10" Add-On Faucet

#600PRD410



Technical Data

Hose Length	44 Inches
Faucet Width	4 Inches
Faucet Height	38 13/16 Inches
Add-On Faucet	10 Inches
Add-on Flow Rate	2 GPM
Add-On Type	Swing
Cartridge Type	Ceramic
Faucet Centers	4 Inches
Finish	Chrome
Handle Type	Lever

Features

- 44" hose, 1.15 GPM spray valve
- Deck-mounted design with 4" centers, 1/2" NPT inlets
- Quarter-turn ceramic cartridges for long life and leak protection, check valves prevent backflow
- Easy to install faucet base and spray valve, chrome-plated brass construction
- 10" add-on faucet (2 GPM), 18" riser

Certifications



NSF/ANSI 61 & 372



NSF Listed



CSA, US and Canada



1/2" Water Connection

Technical Data

Features	California AB100 Compliant NSF/ANSI 372 NSF/ANSI 61 With Riser
Material	Brass
Mounting Style	Deck Mounted
Mounting Type	Adjustable
Pre Rinse Unit Type	Hose and Spring
Spray Valve Flow Rate	1.15 GPM
Temperature Rating	140 Degrees Fahrenheit
Water Inlet Size	1/2 Inches

Plan View

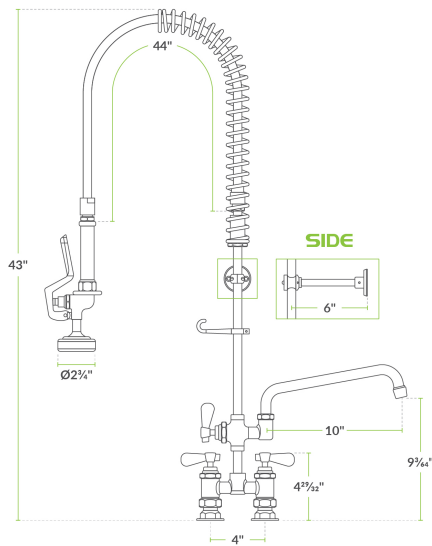

Notes & Details

This Regency deck-mounted pre-rinse faucet with 4" centers is perfect for rinsing excess food and sauces off of your dishes prior to running them through your commercial dish machine. A quality pre-rinse unit is vital to any dishroom, removing the heaviest food debris so that dishes come out clean and ready to use. Designed with a chrome-plated brass faucet body and ceramic cartridges, it's easy to see why Regency pre-rinses are a great solution for any business.

A long, 44" flexible hose gives you plenty of reach to deliver water where you need it, letting you handle glassware and dinnerware, or bulky items like pots and pans. The spray valve delivers a flow rate of 1.15 GPM, giving you the power needed to blast away food debris while being easy on your water bill. This pre-rinse unit also comes with a 10" add-on faucet for times when you need a normal faucet instead of a spray valve. It is perfect for filling up sink compartments to complete your warewashing tasks. It's also great for mixing up cleaning solutions in sanitation pails.

This reliable faucet uses ceramic cartridges, which provide a much lower fail rate than the compression cartridges widely used in the industry. In this design, 2 ceramic discs fit together to create a watertight seal when closed. This removes the need for a rubber seat washer, which is one of the most frequently replaced parts on a faucet. This is a deck-mounted faucet, and it comes with 4" adjustable centers that make installation easy. A set of 1/2" NPT inlets make it easy to connect it to your facility's water lines. This pre-rinse unit comes with an 18" riser.

 **WARNING:** This product can expose you to chemicals including lead, which are known to the State of California to cause cancer, birth defects, or other reproductive harm. For more information, go to www.p65warnings.ca.gov.