

Project	Quantity	Item #
Model Specified:		CSI Section 11400

"W-Width" Pass-Thru Hot Food Holding Cabinets



Model Shown One Section
(shown with optional casters)

One, Two & Three Section Models, 32" Deep



Stainless Exterior & Interior

1-Section Full Length Door Model	RHF132WP-FHS*
2-Section Full Length Door Model	RHF232WP-FHS*
3-Section Full Length Door Model	RHF332WP-FHS
1-Section Half Length Door Model	RHF132WP-HHS*
2-Section Half Length Door Model	RHF232WP-HHS*
3-Section Half Length Door Model	RHF332WP-HHS



Stainless Exterior, Anodized Aluminum Interior

1-Section Full Length Door Model	AHF132WP-FHS*
2-Section Full Length Door Model	AHF232WP-FHS*
3-Section Full Length Door Model	AHF332WP-FHS
1-Section Half Length Door Model	AHF132WP-HHS*
2-Section Half Length Door Model	AHF232WP-HHS*
3-Section Half Length Door Model	AHF332WP-HHS

In addition to the already outstanding cabinet construction you have come to expect from Traulsen, these dependable pass-thru hot food holding cabinets are built using our high performance ducted fan air distribution system. Unlike designs which simply radiate heat, this minimizes temperature stratification inside the cabinet, while providing for quicker daily start-up, lower energy usage, and reduced lifetime service costs. Each is supplied standard with easy to operate microprocessor controls and stainless steel exteriors.

Standard Product Features

- Traulsen's Smart Control With LED Display
- R-Series: Stainless Steel Exterior & Interior
- A-Series: Stainless Steel Exterior/Anodized Aluminum Interior
- Ducted Fan Air Distribution System
- Standard Operating Temperature Range 140 to 180°F
- One-Time Start-Up Temperature Adjustment Feature
- ON/OFF Switch Located On Control Face
- Full or Half Length Stainless Steel Doors With Locks
- Self-Closing Doors With Stay Open Feature At 120°
- Guaranteed For Life Cam-Lift Hinges
- Guaranteed For Life Horizontal Work Flow Door Handles
- Standard Door Hinging F & R: 132W = Right, 232W = Left/Right, 332W = Left/Right/Right (other hingsings available)
- Automatically Activated Incandescent Lights
- Stainless Steel Breaker Caps
- Three Adjustable Wire Shelves Per Section, Supported On Pilasters (installed at the factory)
- Magnetic Snap-In EZ-Clean Door Gasket(s)
- Gasket-Protecting Metal Door Liner
- Stainless Steel One-Piece Louver Assembly - Front & Rear
- 9' Cord & Plug Attached (one section models only)
- Set of Four (4) 6" High Adjustable Stainless Steel Legs
- Three Year Parts And Labor Warranty

Options & Accessories

- Re-Hinging Feature For Door(s)
- No. 1 Type Tray Slides To Accommodate either (1) 18" x 26" or (2) 14" x 18" Pans
- No. 4 Type Tray Slides To Accommodate (1) 18" x 26" Pans (rod type, equips 1/2 section)
- Universal Type Tray Slides To Accommodate Either (1) 18" x 26" or (2) 14" x 18", or (2) 12" x 20" Pans
- Additional Wire Shelves
- EZ-Change Interiors (#1, universals, universal heavy duty tray slides and shelves)
- EZ-Open Foot Pedal (full height doors only)
- Locking Hasps (padlocks supplied by others)
- 115/60/1 Voltage (single section models only)
- Export 220/50/1 Voltage
- Stainless Steel Shelves In Lieu of Standard Wire
- Kool Klad Exterior Laminate Decor
- Set of Four (4) 6" High Casters In Lieu of Legs
- Set of Four (4) 4-5/8" High Casters In Lieu of Legs
- 4-1/2" High Stainless Steel Base In Lieu of Legs
- 6" High Stainless Steel Kickplate (for use with standard legs)
- Clear Glass Door(s) In Place Of One Or More Solid Door(s)
- Fluorescent Lights
- Prison/Correctional Facilities Options



Listed by Underwriters Laboratories Inc., to U.S. and Canadian safety standards and Listed by NSF International.



* Noted models are ENERGY STAR® listed. Please refer to www.energystar.gov to view the most up-to-date product listing and performance data.

Approval: _____

TRAULSEN
4401 BLUE MOUND RD.
PHONE 1 (800) 825-8220
Website: www.traulsen.com

FT. WORTH, TX 76106
FAX-MKTG. 1 (817) 624-4302



Project

Quantity

Item #

Model Specified:

CSI Section 11400

Specifications

Construction, Hardware and Insulation

Cabinet exterior front, one piece sides, louver assembly and doors are constructed of 20 gauge stainless steel with #4 finish. Cabinet interior and door liners are constructed of stainless steel (anodized aluminum in the A-Series). The exterior cabinet top and bottom are constructed of heavy gauge galvanized steel. A set of four (4) adjustable 6" high stainless steel legs are included.

Doors are equipped with a gasket protecting metal door pan, removable plug cylinder locks and guaranteed for life cam-lift, gravity action, self-closing metal, glide hinges with stay open feature at 120°. Hinges include a concealed switch to automatically activate the interior incandescent lighting. Guaranteed for life, work flow door handles are mounted horizontally over recess in door which limits protrusion from door face into aiseways. Doors have seamless, polished metal corners.

Gasket profile and Santoprene® material simplify cleaning and increase overall gasket life.

Both the cabinet and doors are insulated with an average of 2" thick high density, non-CFC, foamed in place polyurethane.

Heating System

A low watt density, serpentine style, heater is employed for the generation of electric heat. Low velocity air is forced across its large surface area to efficiently move heat radiating away from these through a down-air distribution duct, where it is then evenly distributed throughout the cabinet, assuring the proper holding environment for hot food product, without drying. A vent, located at the top of the cabinet, is included for positive humidity control.

Controller

Traulsen's Smart Control features advanced control algorithms and sophisticated diagnostic capabilities. Smart sensors will adapt the operation of the system to a variety of environments and usage patterns. The Smart Control offers a complete set of visual alarms designed to alert the user to critical events. In the event of an alarm, a dedicated Alarm LED will illuminate, informing the user of the critical event and describing the event in the large, easy to read full text display.

Interior

Standard interior arrangements include three (3) coated wire shelves per section, mounted on pilasters. Shelves are full-width, and do not have any large gaps between them requiring the use of "bridge" or "junior shelves". Recommended load limit per shelf should not exceed 225 lbs. Optional tray slides may be purchased in combination with, or in lieu of these. Interior arrangements are installed at the factory.

Warranties

A three year parts and labor warranty is provided standard.

DIMENSIONAL DATA	R/AHF132WP	R/AHF232WP	R/AHF332WP
Net capacity cu. ft.	26.1 (739 cu l)	55.8 (1581 cu l)	83.2 (2357 cu l)
Length - overall in.	29 $\frac{7}{8}$ (75.9 cm)	58 (147.3 cm)	86 $\frac{5}{8}$ (218.8 cm)
Depth - overall in.	37 $\frac{15}{16}$ (96.4 cm)	37 $\frac{15}{16}$ (96.4 cm)	37 $\frac{15}{16}$ (96.4 cm)
Depth - over body in.	32 (81.3 cm)	32 (81.3 cm)	32 (81.3 cm)
Depth - doors open 90° in.	83 $\frac{3}{8}$ (211.8 cm)	83 $\frac{3}{8}$ (211.8 cm)	83 $\frac{3}{8}$ (211.8 cm)
Clear door width in. ¹	21 $\frac{1}{8}$ (53.6 cm)	21 $\frac{1}{8}$ (53.6 cm)	21 $\frac{1}{8}$ (53.6 cm)
Clear half-door height in.	27 $\frac{1}{2}$ (69.9 cm)	27 $\frac{1}{2}$ (69.9 cm)	27 $\frac{1}{2}$ (69.9 cm)
Clear full-door height in.	57 $\frac{5}{8}$ (146.3 cm)	57 $\frac{5}{8}$ (146.3 cm)	57 $\frac{5}{8}$ (146.3 cm)
Height - overall on 6" legs	83 $\frac{3}{4}$ (211.5 cm)	83 $\frac{3}{4}$ (211.5 cm)	83 $\frac{3}{4}$ (211.5 cm)
RHF Net Wt. lbs. ²	345 (156 kg)	585 (265 kg)	1040 (488 kg)
AHF Net Wt. lbs. ²	295 (134 kg)	505 (229 kg)	785 (356 kg)
No. Standard Shelves	3	6	9
Shelf area sq. ft. ³	18.8 (1.75 sq m)	37.6 (3.49 sq m)	56.4 (5.23 sq m)
ELECTRICAL DATA			
Voltage	208/115/60/1	208/115/60/1	208/115/60/1
Feed wires with Ground	4	4	4
Wattage @ 208V	1500	3000	3000
Full load amps @ 208V ⁴	7.8	15.5	15.5
Full load amps @ 115V ⁵	13.8	n/a	n/a
SHIPPING DATA			
Length - crated in.	35 (89 cm)	63 (160 cm)	91 (231 cm)
Depth - crated in.	43 (109 cm)	43 (109 cm)	43 (109 cm)
Height - crated in.	83 $\frac{1}{2}$ (212 cm)	83 $\frac{1}{2}$ (212 cm)	83 $\frac{1}{2}$ (212 cm)
Volume - crated cu. ft.	71 (2011 cu l)	131 (3711 cu l)	189 (5354 cu l)

NOTES

NOTE: Figures in parentheses reflect metric equivalents.

- Please note that the available cabinet width narrows for 5-3/8" from the top of the door frame to 20-1/8" in order to allow for the heater fans.
- For shipping weights and dimensions please refer to form TR35875.
- Area of standard shelf compliment only, does not include storage area of additional shelves or available on cabinet bottom.
- Heater is capable of operation from 208V to 240V as supplied standard. Actual amp figure will change at any voltage other than 208.
- Figure shown for optional 115V.



Equipped With One NEMA L14-20P Plug
(1 section models @208V only)



Equipped With One NEMA 5-20P Plug
(1 section models @115V only)

NOTE: When ordering please specify: Voltage, Hinging, Door Size, Options and any additional warranties.

Continued product development may necessitate specification changes without notice.

Part No. TR35793 (REVISED 01-14-19)

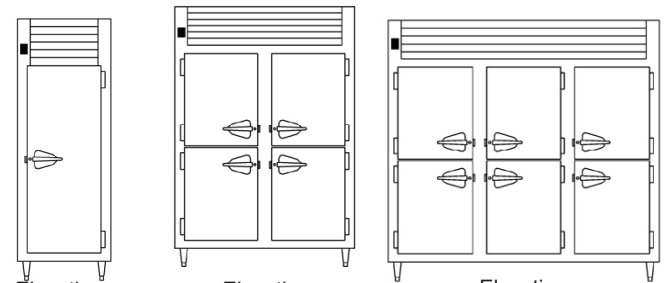
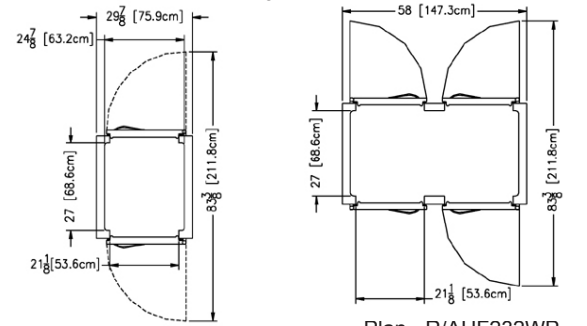
Elevation -
R/AHF132WPElevation -
R/AHF232WPElevation -
R/AHF332WP

Plan - R/AHF132WP

Plan - R/AHF232WP

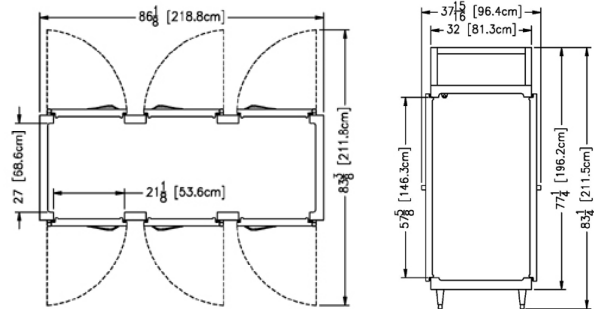

Plan - R/AHF332WP

Section - All Models

TRAULSEN
4401 BLUE MOUND RD.
PHONE 1 (800) 825-8220
Website: www.traulsen.com

FT. WORTH, TX 76106
FAX-MKTG. 1 (817) 624-4302