



18600PDLV

Self-Contained Refrigerated Dual Rail Prep Table with Flush Mount LiquiTec® Raised Rails

Project _____
 Item _____
 Quantity _____
 CSI Section 11400
 Approved _____
 Date _____

18600PDLV

Models

- 18648PDLV 48" Dual Raised Rail LiquiTec Prep Table
- 18672PDLV 72" Dual Raised Rail LiquiTec Prep Table



18648PDLV

Standard Features

- Upper and lower rails are mechanically cooled utilizing LiquiTec® technology with die stamped 12"X20" openings
- Top is constructed of 18-gauge stainless steel
- 22-gauge stainless steel ends are standard
- Pans and adapter bars by others
- 17" polyethylene cutting board is standard
- Flush mount NSF-7 certified pans
- High density environmentally friendly, Kyoto Protocol Compliant, Non ODP (Ozone Depletion Potential), Non GWP (Global Warming Potential) polyurethane foam throughout unit
- Dart style quick change gaskets
- Stainless steel removable hinged covers
- On/off switch is located behind the louver
- 1.50" diameter hole in louver for easy access to rail on/off switch

- 8' long electrical cord
- Environmentally friendly HFC-404A refrigerant
- One year parts and labor standard warranty
- Electronic Controls

Options & Accessories

- Stainless steel back
- Laminate facing (full front), end and/or back
- Tray racks
- Variable cutting board types and sizes
- Cheese grates with removable catch pans
- 27" wide refrigerated drawers (2) high, holds 6" deep pans
- Door/drawer locks
- Adapter bars and pans
- Additional shelf
- Celsius readout for electronic control

Specifications

Exterior Top: Constructed of one-piece 18-gauge stainless steel, with integral 2.12" (5cm) high square nosing at the front. Top has two mechanically cooled LiquiTec® refrigerated raised rails at the rear with openings to accommodate pans (provided by others). Rail interiors are 22-gauge stainless steel. Raised rail openings have 18-gauge stainless steel hinged removable lids. Unit is equipped with separate expansion valve and on/off switch for refrigerated rails. Temperature in top openings maintains 33°F (1°C) to 41°F (5°C) with pans flush mounted at 86°F (29.7°C) ambient room temperature, meeting NSF 7 requirements.

Exterior Back, Bottom and Ends: Unfinished galvanized steel back and bottom. Exterior ends are finished with 22-gauge stainless steel.

Base Interior: Stainless steel back and bottom. Base interior sides and door frames are thermoformed ABS plastic. Each interior door section has (1) 25" (64cm) deep removable epoxy coated wire shelf. Base is insulated with 2" (5cm) high density environmentally friendly, Kyoto Protocol Compliant, Non ODP (Ozone Depletion

Potential), Non GWP (Global Warming Potential) foamed in place polyurethane. End of base has a machine compartment with condensing units installed.

Door(s): 22-gauge stainless steel exterior front, with a thermoformed ABS plastic interior liner.

Refrigeration System: HFC-404A refrigerant. Cabinet has (1) blower coil assembly with expansion valve on 48" and 72" models. Refrigerated base maintains temperature of 36°F (2°C) to 40°F (4°C). On/off switches for rail and base are located behind the louvered panel. A 1.50" diameter hole is on the louver for easy access to rail on/off switch. Electronic control for base reads air temperature. Electronic control for rail displays temperature for set point purposes only. Display does not reflect air or product temps in unit.

Electrical Connections: 115 volt, 60 Hertz, single phase. Unit is wired with 3-wire, grounded, maximum 8' (2.4m) cord and plug.

Casters: Equipment is mounted on 4" (10cm) diameter casters.



18600PDLV

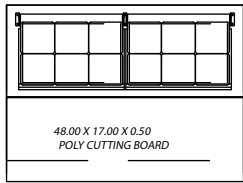

18648PDLV

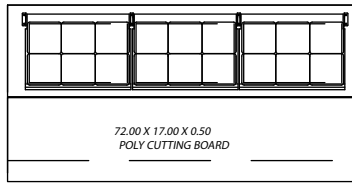

18672PDLV

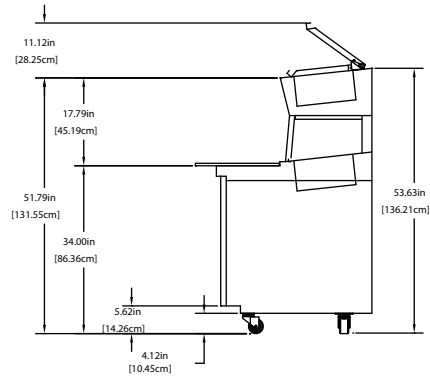
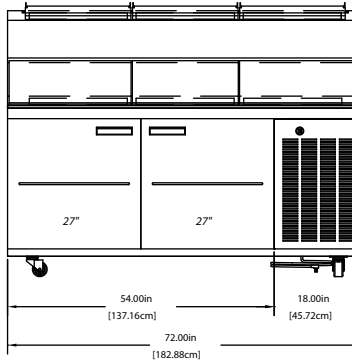
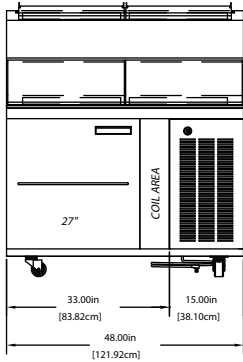
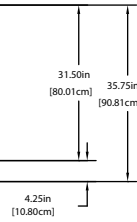

Mechanical Data

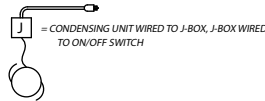
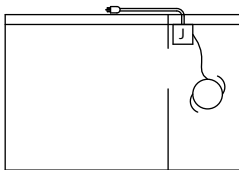

Door Swing

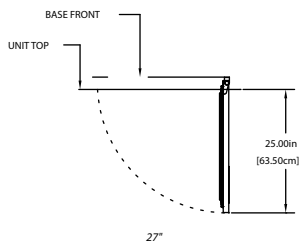

18600PDLV

Specifications

Model	12" x 20" Pan Cap.	# of Shelves	Shelf Area	Volume	H.P.	V/Hz/Ph	Amps	Nema Plug	Ship Weight
18648PDLV	4	1	3.95	8.41	1/5, 1/3	115/60/1	10.1	5-20P	691lbs/313kg
18672PDLV	6	2	7.9	15.42	1/5, 1/2	115/60/1	12.7	5-20P	873lbs/396kg

Welbilt reserves the right to make changes to the design or specifications without prior notice.

18600PDLV