



T&S BRASS AND BRONZE WORKS, INC.

2 Saddleback Cove / P.O. Box 1088
Travelers Rest, SC 29690



REG. #A2601
ISO #9001

Model No.

B-3972-VR

Item No.

Travelers Rest, SC: 800-476-4103 Simi Valley, CA: 800-423-0150 Fax: 864-834-3518 www.tsbrass.com

This Space for Architect/Engineer Approval

Job Name _____ Date _____

Model Specified _____ Quantity _____

Customer/Wholesaler _____

Contractor _____

Architect/Engineer _____



Recessed Hex Screw Requires
1/8" Hex Key for Installation and
Removal of Strainer

Vandal Resistant
Flat Strainer

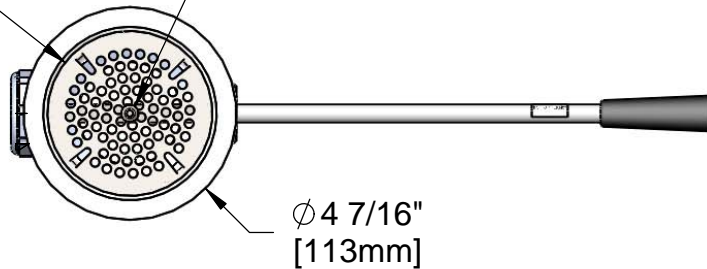

Ø 4 7/16"
[113mm]

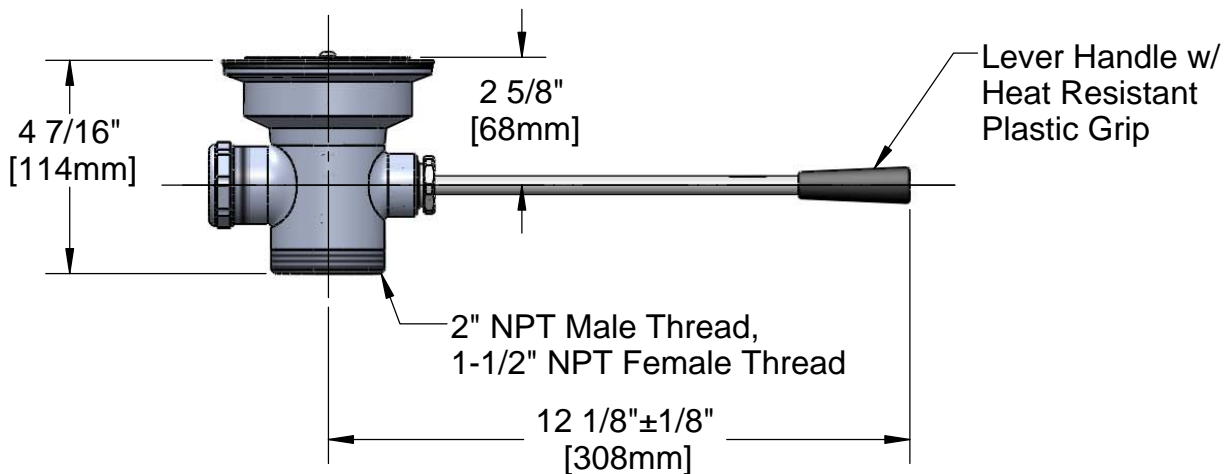

Lever Handle w/
Heat Resistant
Plastic Grip

4 7/16"
[114mm]

2 5/8"
[68mm]

2" NPT Male Thread,
1-1/2" NPT Female Thread

12 1/8" ± 1/8"
[308mm]

Product Specifications:

Waste Drain Valve w/ Lever Handle, 3 1/2" Sink Opening, 2" NPT Male -
1-1/2" NPT Female Thread Outlet, Vandal Resistant Flat Strainer

Drawn
GEF

Checked
KJG

Approved
JHB

Scale:

1:4

Date:

07/15/11



T&S BRASS AND BRONZE WORKS, INC.

2 Saddleback Cove / P.O. Box 1088
Travelers Rest, SC 29690



REG. #A2601
ISO #9001

Model No.

B-3972-VR

Item No.

Travelers Rest, SC: 800-476-4103 Simi Valley, CA: 800-423-0150 Fax: 864-834-3518 www.tsbrass.com

ITEM NO.	SALES NO.	DESCRIPTION
1	010386-45VR	Vandal Resistant Locking Flat Strainer, 3-1/2"
2	010384-45	Flange, 3 1/2" Face
3	010382-45	Gasket, 3 1/2" Face Flange
4	010388-45	Plunger, Lever and Twist Drain
5	010389-45	O-Ring, Plunger
6	010390-45	Ferrule, Coupling Nut
7	010391-45	Nut, Coupling For Twist Drain
8	010394-45	Rod Asm, Waste Drain Lever
9	010392-45	Bushing, Waste Drain Lever Handle

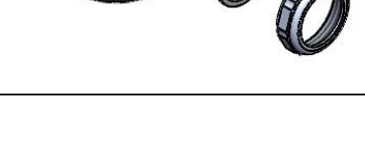
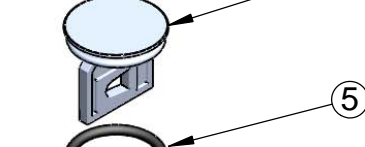
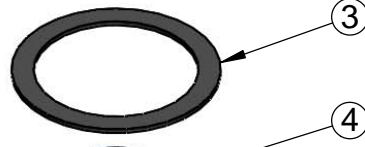
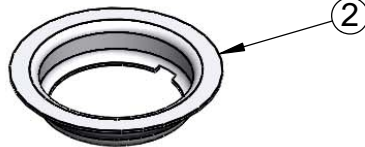
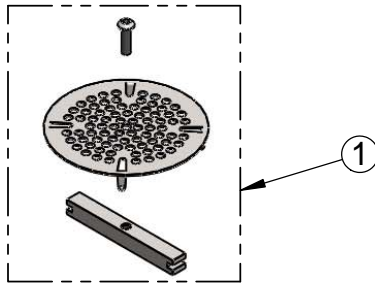

Washers, O-Rings & Gaskets are Included in Parts Kit B-39K

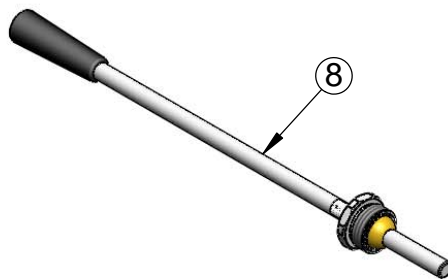

Also Furnished w/ Sealing Cap When Overflow Tube Coupling Nut is Not Used.
PN# 012640-45

Product Specifications:

Waste Drain Valve w/ Lever Handle, 3 1/2" Sink Opening, 2" NPT Male - 1-1/2" NPT Female Thread Outlet, Vandal Resistant Flat Strainer

Drawn GEF	Checked KJG	Approved JHB
Scale: 1:4		Date: 07/15/11