



Project \_\_\_\_\_  
 Item # \_\_\_\_\_  
 Quantity \_\_\_\_\_

## Remote Refrigerated Drop-In Wells

Models: CWBR-1, -2, -3, -4, -5, -6  
 CWBX-1, -2, -3, -4, -5, -6

Hatco's Remote Refrigerated Drop-In Wells keep pre-chilled food products at safe serving temperatures but in remote configurations that offer more flexibility in your particular dining design needs. Unique top angled inside wall design allows cold air to effectively blanket your food product to keep food optimally cold and fresh.

### Standard features

- R-513A refrigerant available for California only. Please contact Hatco for more information
- Top mount unit holds full-size pans in 1- to 6-pan configurations
- NSF 7 approved cold wall construction utilizes a refrigerant that keeps food product cold without drying it out

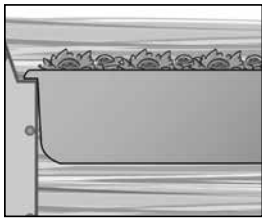

*The unique angled inside wall design provides easy access and clear views. The greater surface area of the angled wall and the placement of the coils allow cold air to more effectively blanket your food product.*

- Auto-defrost is activated through an advanced electronic controller programmed at the customer location
- 1" NPT brass drain simplifies cleaning
- Matches the Hatco line of Wells for a full integrated look
- **CWBR-S models only:**
  - Include a condensing unit (shipped loose – can be field mounted up to 50' [15.24 meters] of tubing from unit) and control panel (shipped loose – probe wires are 9' [2.7 meters]) for installing in more convenient or desirable locations
- **CWBX-S models only:**
  - Includes a control panel (shipped loose – probe wires are 9' [2.7 meters]) but without a condensing unit for the increased flexibility of multiple cold well configurations

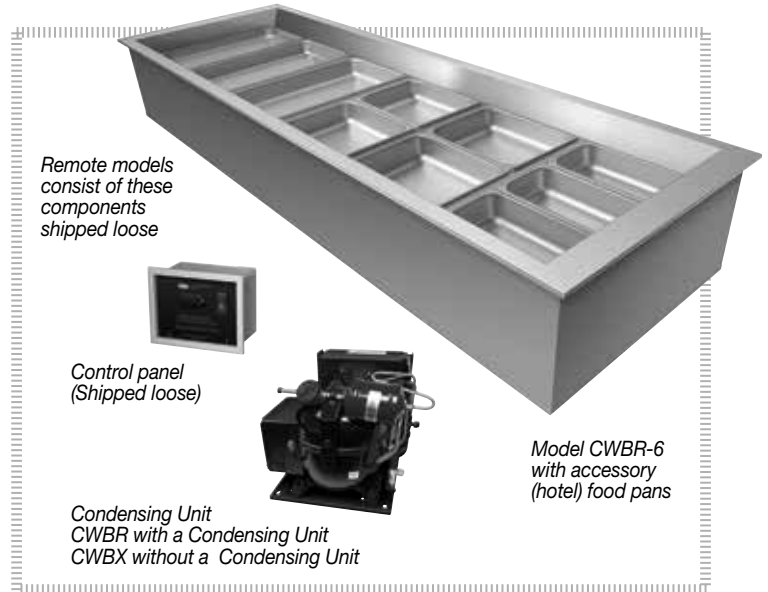

### Options (available at time of purchase only)

- Additional Four-Year Parts Only Warranty on the Compressor (CWBR only) at Time of Unit Purchase (Not available for export voltages)
- Slant Kit to give Cold Wells a 5° tilt

### Accessories

- Pan Support Bars
- 12" (305 mm), hangs from 20" (508 mm) Pan Support Bar
  - 20" (508 mm), hangs from pan shelf
- Stainless Steel Food Pans:
- Third-Size (2.5" [64 mm] H)
  - Half-Size (2.5" [64 mm] H)
  - Full-Size (2.5" [64 mm] H)
  - Full-Size (4" [102 mm] H)
  - Full-Size (6" [152 mm] H)
- False Bottom (perforated false bottom)
- Wire Trivets Stainless:
- Half-Size (10.19" [259 mm] W x 7.625 [194 mm] D)
  - Full-Size (10.125" [259 mm] W x 18" [457 mm] D)

**For operation, location and safety information, please refer to the Installation & Operating Manual.**



**HATCO CORPORATION** | P.O. Box 340500 Milwaukee, WI 53234-0500 U.S.A.  
 (800) 558-0607 | (414) 671-6350 | www.hatcocorp.com | support@hatcocorp.com



# Remote Refrigerated Drop-In Wells

Models: CWBR-1, -2, -3, -4, -5, -6, CWBX-1, -2, -3, -4, -5, -6

## Ordering Instructions:

Please specify the following with each order:

- Desired Voltage and Hz:**  
120 (60 Hz),  
220, 230 or 240V (50 or 60 Hz)
- Number of Drop-In Wells Required:**  
1-, 2-, 3-, 4-, 5- or 6-pan as rectangular, full-size, 12" x 20", (305 mm x 508 mm)
- Remote Refrigeration**  
**NOTE:** Shipped loose: Cold Well with Temperature Probe, Control Panel (Probe Wires are 9' (2.7 meters) and a TXV valve  
**A. CWBR with a Condensing Unit** – may be field mounted up to 50' (15.24 meters) of tubing from the unit - shipped loose  
**B. CWBX without a Condensing Unit** (Solenoid Valve attached to Cold Well)

### Option

- Slant Option for CWBR or CWBX-1, -2, -3, -4, -5 or -6

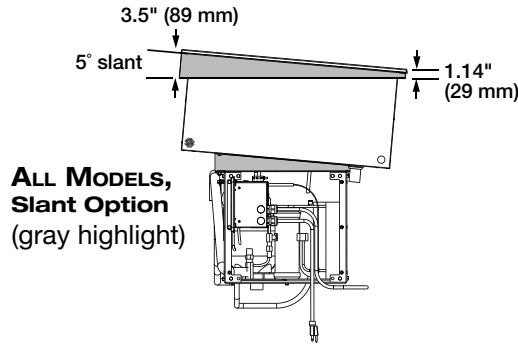

**ALL MODELS False Bottom Accessory**  
1-part, 2- or 3-part, depending on pan size

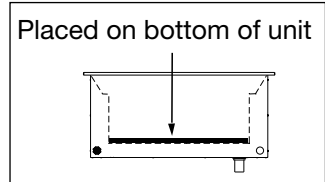

### Models CWBR-1, CWBX-1

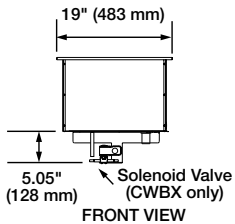

### CWBR-2, CWBX-2

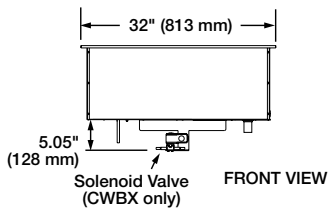

### CWBR-3, CWBX-3

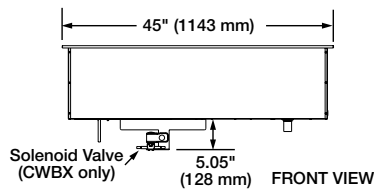

### CWBR-4, CWBX-4

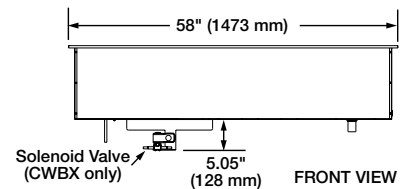

### CWBR-5, CWBX-5

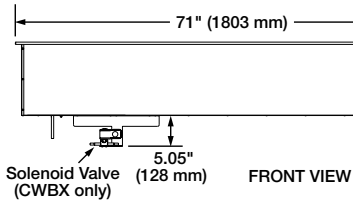

### CWBR-6, CWBX-6

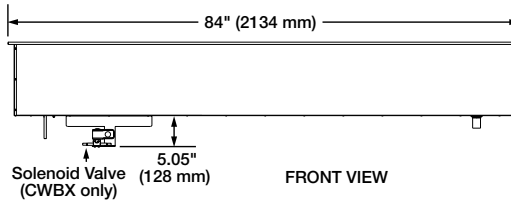

### Side View-All Models

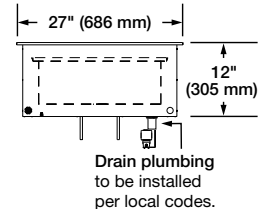

### All Models Control Panel

May be field mounted up to 9' (2.7 meters) from unit

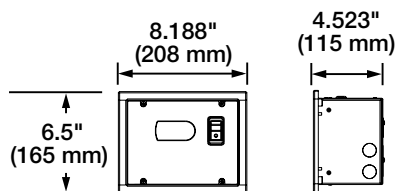

### Model CWBR only, Condensing Unit

May be field mounted up to 50' (15.24 meters) from unit

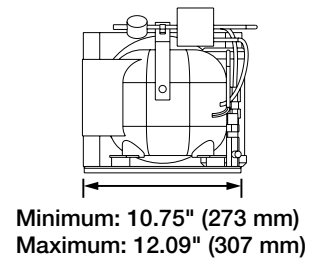
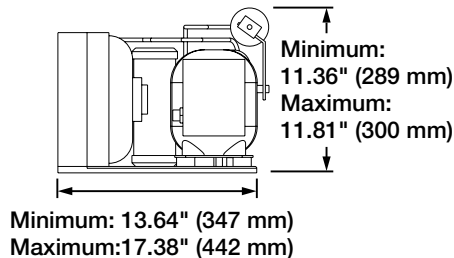

Contact Hatco for R-513A refrigerant specifications.



# Remote Refrigerated Drop-In Wells

Models: CWBR-1, -2, -3, -4, -5, -6, CWBX-1, -2, -3, -4, -5, -6

## Cutout Dimensions for Remote Refrigerated Drop-In Wells

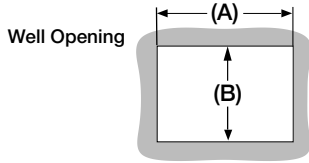

| Model         | Minimum Width (A) | Maximum Width (A) | Minimum Depth (B) | Maximum Depth (B) |
|---------------|-------------------|-------------------|-------------------|-------------------|
| CWBR-, CWBX-1 | 17.125" (435 mm)  | 18" (457 mm)      | 25.19" (640 mm)   | 26" (660 mm)      |
| CWBR-, CWBX-2 | 30.125" (765 mm)  | 31" (787 mm)      |                   |                   |
| CWBR-, CWBX-3 | 43.125" (1095 mm) | 44" (1118 mm)     |                   |                   |
| CWBR-, CWBX-4 | 56.125" (1426 mm) | 57" (1448 mm)     |                   |                   |
| CWBR-, CWBX-5 | 69.125" (1756 mm) | 70" (1778 mm)     |                   |                   |
| CWBR-, CWBX-6 | 82.125" (2086 mm) | 83" (2108 mm)     |                   |                   |

## SPECIFICATIONS

### Drop-In Full-Size Models - with Condensing Unit\* and Remote Control Panel

The shaded areas contain electrical information for International models

| Model† | Dimensions<br>(Width x Depth x Height)   | Volts       | HP Compressor<br>Size | HZ  | Watts          | Amps        | Phase  | Ship Weight      |                  |                  |                   |
|--------|--|-------------|-----------------------|-----|----------------|-------------|--------|------------------|------------------|------------------|-------------------|
| CWBR-1 | 19" x 27" x 12"<br>(483 x 686 x 305 mm)  | 120         | 1/4                   | 60  | 804            | 6.7         | Single | 131 lbs. (59 kg) |                  |                  |                   |
|        |  | 220/230/240 | 1/3                   | 50  | 616-744        | 2.8/2.9/3.1 |        |                  |                  |                  |                   |
|        |  |             |                       | 60  | 686-816        | 3.1/3.3/3.4 |        |                  |                  |                  |                   |
| CWBR-2 | 32" x 27" x 12"<br>(813 x 686 x 305 mm)  | 120         | 1/4                   | 60  | 804            | 6.7         |        | Single           | 160 lbs. (73 kg) |                  |                   |
|        |  | 220/230/240 | 1/3                   | 50  | 616-744        | 2.8/2.9/3.1 |        |                  |                  |                  |                   |
|        |  |             |                       | 60  | 686-816        | 3.1/3.3/3.4 |        |                  |                  |                  |                   |
| CWBR-3 | 45" x 27" x 12"<br>(1143 x 686 x 305 mm) | 120         | 1/2                   | 60  | 804            | 6.7         |        |                  | Single           | 213 lbs. (97 kg) |                   |
|        |  | 220/230/240 | 1/3                   | 50  | 616-744        | 2.8/2.9/3.1 |        |                  |                  |                  |                   |
|        |  |             |                       | 60  | 686-816        | 3.1/3.3/3.4 |        |                  |                  |                  |                   |
| CWBR-4 | 58" x 27" x 12"<br>(1473 x 686 x 305 mm) | 120         | 1/3                   | 60  | 468            | 6.5         |        |                  |                  | Single           | 235 lbs. (107 kg) |
|        |  | 220/230/240 | 3/8                   | 50  | 807/882/960    | 3.7/3.8/4.0 |        |                  |                  |                  |                   |
|        |  |             |                       | 1/3 | 60             | 686/749/816 |        |                  |                  |                  |                   |
| CWBR-5 | 71" x 27" x 12"<br>(1803 x 686 x 305 mm) | 120         | 1/2                   | 60  | 1380           | 11.5        | Single |                  |                  |                  | 271 lbs. (123 kg) |
|        |  | 220/230/240 |                       | 50  | 1190/1300/1416 | 5.4/5.7/5.9 |        |                  |                  |                  |                   |
|        |  |             |                       | 60  | 1210/1322/1440 | 5.5/5.8/6.0 |        |                  |                  |                  |                   |
| CWBR-6 | 84" x 27" x 12"<br>(2134 x 686 x 305 mm) | 120         | 1/2                   | 60  | 1380           | 11.5        |        | Single           |                  |                  | 313 lbs. (142 kg) |
|        |  | 220/230/240 |                       | 50  | 1190/1300/1416 | 5.4/5.7/5.9 |        |                  |                  |                  |                   |
|        |  |             |                       | 60  | 1210/1322/1440 | 5.5/5.8/6.0 |        |                  |                  |                  |                   |

†Models shipped with electronic temperature control, condensing unit and TXV (all shipped loose).

\*Contact Hatco for R-513A refrigerant specifications.



# Remote Refrigerated Drop-In Wells

Models: CWBR-1, -2, -3, -4, -5, -6, CWBX-1, -2, -3, -4, -5, -6

## SPECIFICATIONS

### Drop-In Wells Full-Size Models - with Remote Control Panel (without a Condensing Unit)

The shaded areas contain electrical information for International models

| Model† | Dimensions <sup>Δ</sup><br>(Width x Depth x Height) | Volts       | Load/BTU/Hour | HZ    | Ship Weight       |
|--------|---|-------------|---------------|-------|-------------------|
| CWBX-1 | 19" x 27" x 17.05"<br>(483 x 686 x 433 mm)          | 120         | 330           | 60    | 94 lbs. (43 kg)   |
|        |   | 220/230/240 |               | 50/60 |                   |
| CWBX-2 | 32" x 27" x 17.05"<br>(813 x 686 x 433 mm)          | 120         | 630           | 60    | 123 lbs. (56 kg)  |
|        |   | 220/230/240 |               | 50/60 |                   |
| CWBX-3 | 45" x 27" x 17.05"<br>(1143 x 686 x 433 mm)         | 120         | 930           | 60    | 150 lbs. (68 kg)  |
|        |   | 220/230/240 |               | 50/60 |                   |
| CWBX-4 | 58" x 27" x 17.05"<br>(1473 x 686 x 433 mm)         | 120         | 1230          | 60    | 176 lbs. (80 kg)  |
|        |   | 220/230/240 |               | 50/60 |                   |
| CWBX-5 | 71" x 27" x 17.05"<br>(1803 x 686 x 433 mm)         | 120         | 1530          | 60    | 211 lbs. (96 kg)  |
|        |   | 220/230/240 |               | 50/60 |                   |
| CWBX-6 | 84" x 27" x 17.05"<br>(2134 x 686 x 433 mm)         | 120         | 1830          | 60    | 250 lbs. (113 kg) |
|        |   | 220/230/240 |               | 50/60 |                   |

†Models shipped with electronic temperature control, TXV (all shipped loose) and a solenoid valve attached to well.

<sup>Δ</sup> For CWBX models only, 5.05" (128 mm) has been added to the height for the attached solenoid valve.

## PRODUCT SPECS

### Remote Refrigerated Drop-In Wells

The NSF 7 approved Remote Refrigerated Drop-in Well shall be a Model ... as manufactured by the Hatco Corporation, Milwaukee, WI 53234 U.S.A.

The Refrigerated Drop-in Well shall be rated at ... watts, ... volts, ... hp, and be ... inches (millimeters) in overall width and be ... inches (millimeters) in overall depth. It shall utilize R-404A or R-513A refrigerant and consist of aluminized steel housing with a stainless bezel, an

electronic temperature control, pan support bars for full-size pans and with or without a condensing unit (compressor, sight glass, service valves, receiver, and dryer.)

Accessories may include pan support bars, false bottoms, trivets and stainless steel food pans.

Warranty consists of 24/7 parts and service assistance (U.S. and Canada only).

**HATCO CORPORATION** | P.O. Box 340500 Milwaukee, WI 53234-0500 U.S.A.  
 (800) 558-0607 | (414) 671-6350 | [www.hatcocorp.com](http://www.hatcocorp.com) | [support@hatcocorp.com](mailto:support@hatcocorp.com)