

Electric Bain Marie Buffet Countertop Food Warmer

ITEM NUMBER

#177BMFW4

SPECIAL FEATURES

- Ensures minimal downtime between large groups of guests, perfect for hotels and cafeterias
- Includes (4) 1/2 size, 4" deep stainless steel food pans with covers
- Thermostatic control adjusts temperature between 85-185°F
- Stainless steel with a sneeze guard to protect food from contaminants; rear drain valve simplifies cleaning
- Easy-to-transport size makes it easy to carry between catering sites

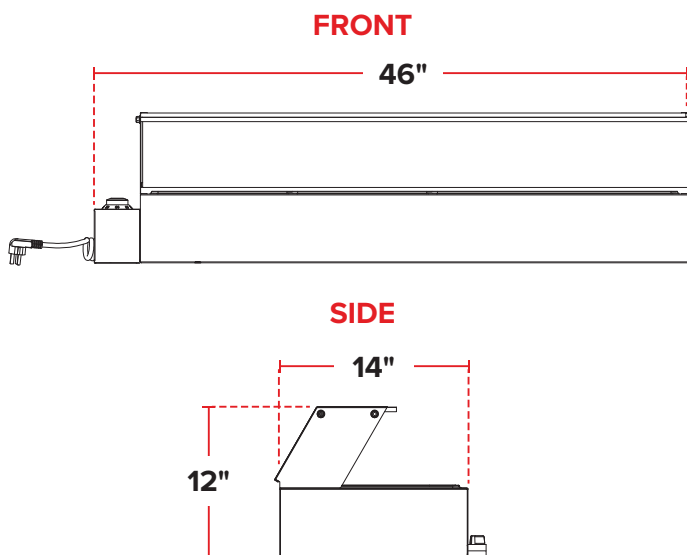

TECHNICAL DATA

Width	46"
Height	12"
Depth	14"
Voltage	120
Wattage	1500



5-15P