



# Operators Manual

## Installation & Operation

### Gas Floor Model Vertical Mixer Kettles

**MODELS:**  
MKGL-40-T  
MKGL-60-T  
MKGL-80-T  
MKGL-100-T

**For units built prior to July 2010**



*For a complete Service Manual  
refer to [www.clevelandrange.com](http://www.clevelandrange.com)*



Enodis

1333 East 179th St., Cleveland, Ohio, U.S.A. 44110

Phone: (216) 481-4900 Fax: (216) 481-3782  
Visit our web site at [www.clevelandrange.com](http://www.clevelandrange.com)

# FOR THE USER

## **IMPORTANT!**

**ENSURE KETTLE IS AT ROOM TEMPERATURE AND PRESSURE GAUGE IS SHOWING ZERO OR LESS PRESSURE PRIOR TO REMOVING ANY FITTINGS.**

### **FOR YOUR SAFETY**

DO NOT STORE OR USE GASOLINE OR ANY OTHER FLAMMABLE LIQUIDS AND VAPOURS IN THE VICINITY OF THIS OR ANY OTHER APPLIANCE.

**WARNING:** Improper installation, adjustment, alteration, service or maintenance can cause property damage, injury or death. Read the installation and operating instructions thoroughly before installing or servicing this equipment.

## **IMPORTANT**

The following points are to insure the safe installation and operation of this equipment:

- Insure all gas and electrical supplies match rating plate and electrical stickers.
- Observe all clearance requirements.
- Disconnect the electrical power supply to the appliance before cleaning or servicing unit.
- All service must be performed by a qualified Cleveland Range Technician.
- Do not obstruct the flow of combustion and ventilation air.

The installation and connection must comply with current local codes, or in the absence of local codes, with CAN/CGA-B149.1 and .2 installation code or with the national fuel gas code, ANSI Z223.1-L988.

Post in a prominent location, instructions to be followed in the event the user smells gas. This information shall be obtained by consulting your local gas supplier.

The appliance and its individual shut off valve must be disconnected from the gas supply piping system during any pressure testing of that system at test pressures in excess of 1/2 psig. (3.45 kpa).

The appliance must be isolated from the gas supply piping system by closing its individual manual shut off valve during any pressure testing of the gas supply piping system at test pressures equal to or less than 1/2 psig. (3.45 kpa).

**RETAIN THIS MANUAL FOR YOUR REFERENCE.**

# For your safety

## DANGER

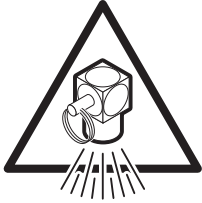

Keep clear of pressure relief discharge.



Keep hands away from moving parts and pinch points.

## IMPORTANT



Inspect unit daily for proper operation.

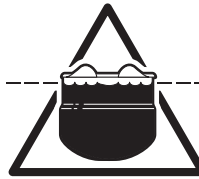

Do not fill kettle above recommended level marked on outside of kettle.

## CAUTION



Surfaces may be extremely hot! Use protective equipment.



Wear protective equipment when discharging hot product.



Do not lean on or place objects on kettle lip.

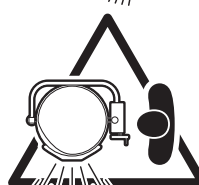

Stand clear of product discharge path when discharging hot product.

## SERVICING

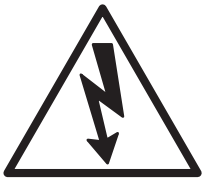

Shut off power at main fuse disconnect prior to servicing.

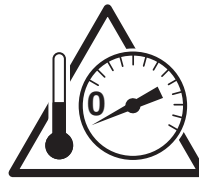

Ensure kettle is at room temperature and pressure gauge is showing zero or less prior to removing any fittings.

## GAS APPLIANCES

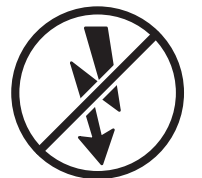

Do not attempt to operate this appliance during a power failure.



Keep appliance and area free and clear of combustibles.

# INSTALLATION

## INSPECTION

Before unpacking visually inspect the unit for evidence of damage during shipping.

If damage is noticed, do not unpack the unit, follow shipping damage instructions.

## SHIPPING DAMAGE INSTRUCTIONS

If shipping damage to the unit is discovered or suspected, observe the following guidelines in preparing a shipping damage claim.

1. Write down a description of the damage or the reason for suspecting damage as soon as it is discovered. This will help in filling out the claim forms later.
2. As soon as damage is discovered or suspected, notify the carrier that delivered the shipment.
3. Arrange for the carrier's representative to examine the damage.
4. Fill out all carrier claims forms and have the examining carrier sign and date each form.

## GENERAL

Installation of the kettle must be accomplished by qualified installation personnel working to all applicable local and national codes. Improper installation of product could cause injury or damage.

This equipment is built to comply with applicable standards for manufacturers. Included among those approval agencies are: UL, A.G.A., NSF, ASME/N.Bd., CSA, CGA, ETL, and others. Many local codes exist, and it is the responsibility of the owner/installer to comply with these codes.

Observe all clearance requirements to provide proper make-up air flow. Do not obstruct the flow of combustion and ventilation air. Check rating plate to ensure that kettle has been equipped to operate with the type of gas available at the installation.

## VENTILATION

Gas fired kettles are only to be installed under a ventilation hood in a room which has provisions for adequate make up air. Further information can be obtained by referring to the U.S.A. National Fire Protection Associations NFPA96 regulations. These standards have also been adopted by the National Building Code in Canada.

## CLEARANCE REQUIREMENTS

This unit must be installed in accordance with the clearances shown on the rating label which is adhered to the unit.

**FOR YOUR SAFETY.** Keep the appliance area free and clear of combustible materials.

## GAS

**ENSURE THE GAS SUPPLY MATCHES THE KETTLE'S REQUIREMENTS AS STATED ON THE RATING PLATE.**

It is recommended that a sediment trap (drip leg) be installed in the gas supply line. If the gas pressure exceeds 14" water column, a pressure regulator must be installed, to provide a maximum of 14" water column gas pressure to the gas control valve.

Connect the gas line to the manual valve located at the rear of the control box.

Installation must be in accordance with local codes and/or the National Fuel Gas Code ANSI Z223.1 Latest Edition (USA) or the latest Installation Codes for Gas Burning Appliances and Equipment CAN/ CGA B149.1 and CAN/ CGA B149.2 (Canada). Use a gas pipe joint compound which is resistant to L.P. gas. Test all pipe joints for leaks with soap and water solution. Ensure that the gas pressure regulator is set for the manifold pressure indicated on the gas rating plate.

The appliance and its individual shut-off valve must be disconnected from the gas supply piping system during any pressure testing of that system at test pressures in excess of 1/2 psi (3.45 kPa). The appliance must be isolated from the gas supply piping system by closing its individual manual shut-off valve during any pressure testing of the gas supply piping system at test pressures equal to or less than 1/2 psi (3.45 kPa).

## WATER

The sealed jacket of the gas-fired kettle is precharged with the correct amount of a water-based formula, and therefore, no water connection is required to the kettle jacket. The kettle can be equipped with optional hot and cold water taps, the taps require 1/2" copper tubing as supply lines.

## CLEANING

After installation the kettle must be thoroughly cleaned and sanitized prior to cooking.

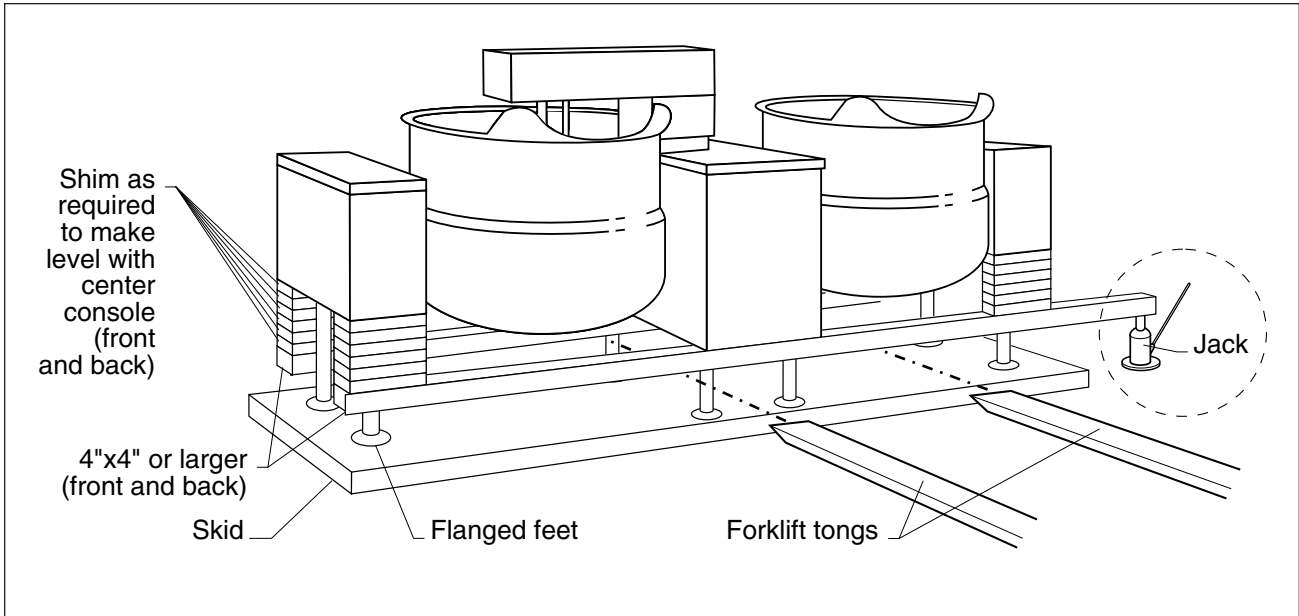

Recommended Installation Procedure

## MOVING UNIT

1. While still on skid, move unit as close to final installation position as possible.
2. Prepare unit for lifting as shown in diagram.
3. Lift gently with a forklift or jacks and remove skid.
4. Lower gently to ground and remove forklift and blocking.
5. If unit has to be re-positioned, slide gently. Do not twist or push one side of unit excessively and cause binding on trunnions.

## LEVELING

**Note:** Instructions reflect a more complicated twin mixer kettle - process for single mixer kettles is the same.

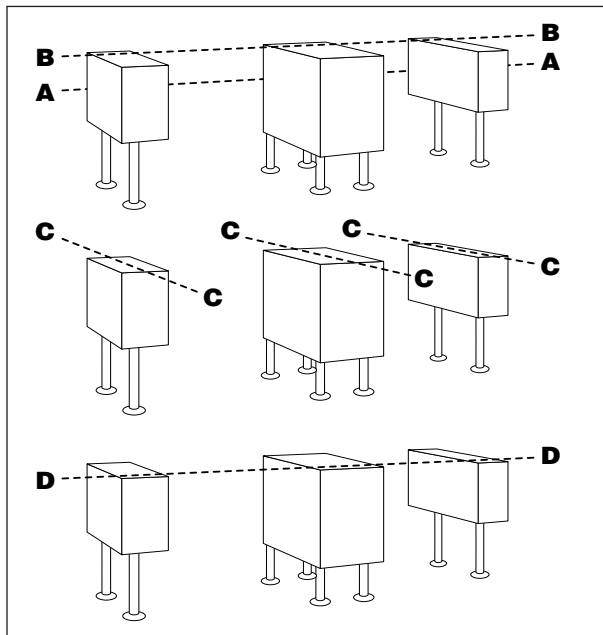

Recommended Leveling Procedure

1. With straight-edge, line the backs of the consoles up with each other (dotted line **A**).

2. Level and straight-edge backs of consoles (dotted line **B**). Adjustments are made by turning flanges on back feet only.
3. Level consoles individually from front to back (dotted lines **C**). Adjustments are made by turning flanges on front feet only.
4. Re-check that the back is level (dotted line **B**) and then the front (dotted line **D**). Adjust if necessary.

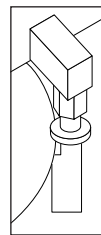

Guide Pins

5. Check that mixer bridge is level and guide pins lock smoothly without binding. If not repeat steps **1** through **4**.

**NOTE:** See Operating Instructions before operating unit.

6. Make electrical connections (see electrical service connections) and test mixer bridge as follows:

- ⇒ **A/** Raise mixer bridge.
- ⇒ **B/** Swing bridge out over centre console.

- ⇒ **C/** Swing bridge to the left as far as possible.
- ⇒ **D/** Lower bridge.
- ⇒ **E/** Bridge pins should enter pin hole on kettle perfectly, If not return to step 1 and repeat leveling steps.
- ⇒ **F/** Raise bridge and swing to far right (for twin mixers only).
- ⇒ **G/** Repeat steps **D** and **E** (for twin mixers only).

7. Once positioned and leveled, permanently secure the kettle's flanged feet to the floor using 5/16 inch stainless steel lag bolts and floor anchors (supplied by the installer). Secure each of the flanged feet with one bolt in each hole. Seal joints of flanged feet with a silicone sealant.

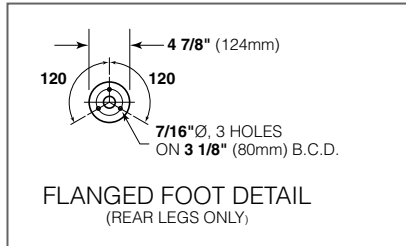

## COMPRESSED AIR CONNECTION

Mixer Kettles with an air activated discharge valve require a minimum of 90 PSI to operate correctly.

If the unit is also supplying air to a Metering Filling Station then a pressure of 100 PSI at a minimum volume of 25 CFM is required.

The air supplied to the mixer should be clean and dry. No oil should be added to the supply air. We recommend the compressed air system be equipped with a drier, filter, and automatic water dump on the air compressor receiver tank. If the distance between the tank and the unit is less than 100 feet then a minimum line size of 3/4" is required. A distance of 100 to 300 feet requires a minimum 1" line.

## ELECTRICAL SERVICE CONNECTIONS

**ENSURE THE ELECTRICAL SUPPLY MATCHES THE KETTLE'S REQUIREMENTS AS STATED ON THE RATING LABEL.**

Install in accordance with local codes and/or the National Electric Code ANSI/NFPA No 70-1981 (USA) or the Canadian Electric Code CSA Standard C22.1 (Canada). A separate fused disconnect switch must be supplied and installed. The kettle must be electrically grounded by the installer.

The electric supply must match the power requirements specified on the kettle's rating plate. The copper wiring must be adequate to carry the required current at the rated voltage.

1. Ensure main power is turned off before connecting wires.
2. Remove the screws at the rear of the mixer console cover, and remove the cover. A wiring diagram is affixed to the underside of the console cover.
3. Feed permanent copper wiring 18" through the cut-out in the bottom of the console. Connect wiring in junction box in the bottom of the console.
4. Turn main power back on.
5. Check for correct rotation of electric motor (access by removing top front cover on center console). If rotation is incorrect, disconnect main power and reverse any two of the three live lines.
6. Replace the console cover and secure it with screws.

# QUALITY ASSURANCE CHECKS

## INSTALLATION

1. Visual                      Examine unit for scratches, dents, or other defects.
2. Visual                      Check flanged feet all have bolts holding them.
3. General                     Check all accessible wiring, mechanical and plumbing connections by hand for secure, tight and satisfactory assembly. Remove all paper.
4. Level                        Check unit has been leveled and squared correctly.

## KETTLE

Although the kettle has been thoroughly tested before leaving the factory, the installer is responsible for ensuring the proper operation of kettle once installed.

**DO NOT ATTEMPT TO OPERATE THIS APPLIANCE DURING A POWER FAILURE.**

**KEEP APPLIANCE AND AREA FREE AND CLEAR OF COMBUSTIBLES.**

1. Before turning the kettle on, read the vacuum/pressure gauge. The gauge's needle should be in the green zone. If the needle is in the "VENT AIR" zone, follow air venting procedure.
2. Supply power to the kettle by placing the fused disconnect switch to the "ON" position.
3. Turn on main gas supply to unit. Open the kettle's shut-off valve (located at back of console).
4. Turn the temperature control knob to "1" (Min.). The green LED light should remain lit, indicating the burner is lit, until the set temperature is reached. Then the green light will cycle on and off, indicating the burner is cycling on and off to maintain temperature.
5. Tilt the kettle forward. After a few seconds the red "LOW WATER" light should be lit when the kettle is in a tilted position. This light indicates that the burner has automatically been shut off by the kettle's safety circuit. This is a normal condition when the kettle is in a tilted position.
6. Raise the kettle to the upright position. The red "LOW WATER" light should go out when the kettle is upright.
7. Turn the temperature control knob to "10" (Max.) and allow the kettle to preheat. The green light should remain on until the set temperature is reached. Then the green light will cycle ON and OFF, indicating the burner is cycling ON and OFF to maintain temperature

## MIXER

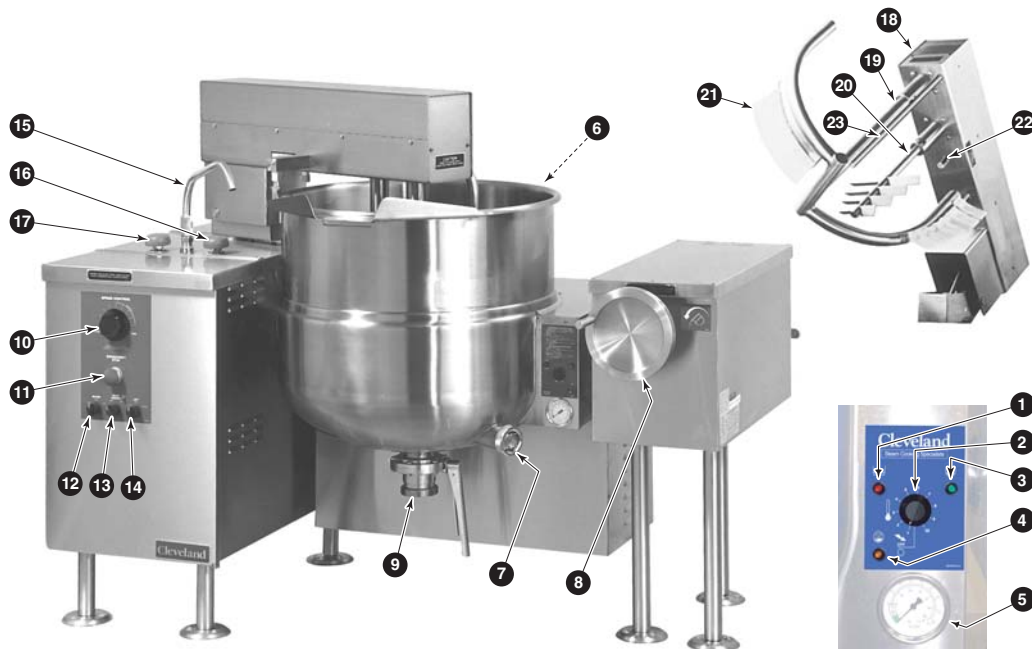

1. Raise Bridge                If bridge does not raise then check motor rotation. Bridge should not raise until speed control is turned to minimum and then adjusted back up.
2. Swing Bridge              Bridge when fully raised should swing without hitting any object, i.e. control housing, kettle lip. Check that hydraulic hoses are not being pinched by stops on swivel assembly.
3. Tilt Kettle                 Kettle tilts smoothly both down and back up. If power tilt, check that micro switches are adjusted properly (kettle is level in upright position and drains fully when tilted) and are not being crushed by gear.
4. Lower Bridge              Raise bridge. Switch to mix. Turn speed control to zero to reset micro switch then set speed control to number four. Check that unit does not begin to mix until bridge has lowered part way into the kettle. Check that mixer bridge pin lowers into pin hole correctly
5. Speed Control - Main        Main agitator arm not rotating when set at "0" but will start to move slowly on "1" . Speed control makes positive contact with micro switch.
6. Speed Control - Secondary    Set main speed control to five. Adjust secondary control from minimum to maximum. Look for considerable speed variance.
7. Water Faucets             Turn on hot water faucet. Turn off and check for leaks in piping and drips from faucet spout. Repeat above with cold water faucet.
8. Product Discharge Valve    Add water to kettle. Check for leaks from valve. Open and close valve a few times and check for leaks again.

# OPERATING INSTRUCTIONS



Operating Controls & Indicators

## ITEM # DESCRIPTION

- |            |   |
|------------|---|
| <b>1.</b>  |  Low Water Indicator Light (Red)              |
| <b>2.</b>  | On-Off Switch/<br>Solid State<br>Temperature Control  |
| <b>3.</b>  |  Heat Indicator Light (Green)                |
| <b>4.</b>  |  Ignition Failure Indicator Light<br>(Amber) |
| <b>5.</b>  | Vacuum/Pressure Gauge   |
| <b>6.</b>  | Pressure Relief Valve<br>(not shown)  |
| <b>7.</b>  | Water Level Sight Glass   |
| <b>8.</b>  | Tilt Wheel  |
| <b>9.</b>  | Butterfly Valve   |
| <b>10.</b> | Mixer Speed Control   |
| <b>11.</b> | Emergency Stop  |
| <b>12.</b> | Main Power Switch   |
| <b>13.</b> | Mix/Lift Switch   |
| <b>14.</b> | Up/Down Switch  |
| <b>15.</b> | Faucet Spout  |
| <b>16.</b> | Cold Water Valve  |
| <b>17.</b> | Hot Water Valve   |
| <b>18.</b> | Mixer Bridge  |
| <b>19.</b> | Main Agitator Arm   |
| <b>20.</b> | Secondary Arm   |
| <b>21.</b> | Scraper Blades  |
| <b>22.</b> | Secondary Speed Control   |
| <b>23.</b> | Temperature Probe   |

## FUNCTION

- |   |
|---|
| When lit, indicates that the kettle is low on water and will not operate in this condition. This will also light when the kettle is tilted.                               |
| Turns kettle ON/OFF and allows the operator to adjust the kettle temperature in increments from 1 (Min.) to 10 (Max.).  |
| When lit, indicates that the kettle's burner is on.<br>Cycles ON-OFF with burner.   |
| Indicates failure of heating system to ignite.<br>(Used prior to July 2004)   |
| Indicate steam pressure in PSI inside steam jacket as well as vacuum in inches of mercury.  |
| This valve is used to vent the kettle and in the unlikely event there is an excess steam build-up in the jacket, this valve opens automatically to relieve this pressure. |
| Displays water level in steam jacket.   |
| Used for tilting the kettle on hand tilt models. In power tilt models there is a toggle switch in same location.  |
| Used for draining product or wash water from kettle.  |
| Controls speed of agitators and mixer bridge lift mode.   |
| Stops hydraulic system.   |
| Power switch for unit.  |
| Sets hydraulics to mix or lift mode.  |
| When unit is in lift mode, bridge can be raised or lowered with this switch.  |
| Delivers water to the kettle.   |
| Turns on cold water.  |
| Turns on hot water.   |
| Encloses agitator motors.   |
| Provides most of the product movement.  |
| Provides reverse agitation and product lift in kettle.  |
| Scrapes the side of the kettle and moves product away.  |
| Controls speed of secondary agitator arm.   |
| Probe holds temperature sensors for controller.   |



# OPERATING THE KETTLE



**Do not attempt to operate this appliance during a power failure.**

**Keep appliance and area free and clear of combustibles.**

**Do not lean on or place objects on kettle lip. Serious injury could result if kettle tipped over, spilling hot contents.**

**If you are cooking an egg or milk product, do not pre-heat kettle.**

## Cooking

1. Before turning kettle on, read the Vacuum/Pressure Gauge (5). The gauges needle should be in the green zone. Once heated, the kettle's normal maximum operating pressure is approximately 10-12 psi while cooking a water base product.
2. Ensure that the electrical service to the kettle is turned on at the fused disconnect switch.

Temperature Control Setting	Approximate Product Temperature	
	°F	°C
<b>1.</b>	120	49
<b>2.</b>	135	57
<b>3.</b>	150	66
<b>4.</b>	165	74
<b>5.</b>	180	82
<b>6.</b>	195	91
<b>7.</b>	210	99
<b>8.</b>	225	107
<b>9.</b>	245	118
<b>10.</b>	265	130

**NOTE:** Certain combinations of ingredients will result in temperature variations.

Temperature Range Chart

3. Preheat the kettle by turning the ON/OFF Switch/Solid State Temperature Control (2) to the desired temperature setting (see above "Temperature Range Chart"). The Heat Indicator Light (Green) (3) will remain lit, indicating the burner is on, until the temperature setting is reached. When the green light goes off, the burners are off, and preheating is complete.

**NOTE:** When cooking egg and milk products, the kettle should not be preheated, as products of this nature adhere to hot cooking surfaces. These types of food should be placed in the kettle before heating is begun.

4. Place food product into the kettle. The green Heat Indicator Light (3) will cycle on and off indicating the burners are cycling on and off to maintain the set temperature.

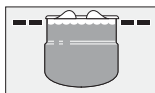

**NOTE:** Do not fill kettle above recommended level marked on outside of kettle.

**NOTE:** The red Low Water Indicator Light (1) should not be lit when the kettle is in the upright position during kettle operation. This light indicates that the burners have been automatically shut off by the kettle's safety circuit. It is, however, normal for the red light to come on when the kettle is in a tilted position.

5. When cooking is completed turn On/Off Switch/Solid State Temperature Control (2) to the "OFF" position.

**NOTE:** A five minute complete shut-of period is required before relighting.

6. Pour the contents of the kettle into an appropriate container by tilting the kettle forward. Care should be taken to pour slowly enough to avoid splashing off the product.

**NOTE:** As with cleaning food soil from any cookware, an important part of kettle cleaning is to prevent food from drying on. For this reason, cleaning should be completed immediately after cooked foods are removed.

## Approximate Boiling Times

The accompanying chart shows approximate times required for gas kettles of various capacities to boil water with the lid open. The ON/OFF Switch/Solid State Temperature Control (2) must be set at "10" throughout the heat-up period. Water will boil about 1/3 faster if the kettle is filled only to the outer steam jacket's welded seam resulting in a kettle filled to 2/3 capacity.

Kettle Capacity	Minutes
40 gallon	35
60 gallon	47
80 gallon	60
100 gallon	75

Approximate Boiling Times

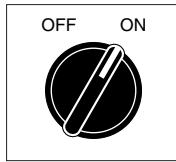

## General Operation

1. Turn MAIN POWER SWITCH (12) to "ON".

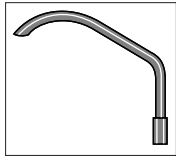

## Adding Water Manually

1. Locate FAUCET SPOUT (15) over desired kettle.
2. Turn on HOT or COLD WATER VALVES (16 or 17).

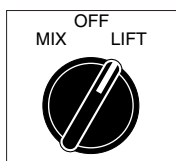
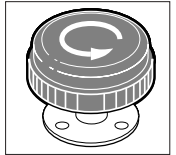

## Lifting & Lowering Bridge

**WARNING-** Insure FAUCET SPOUT (15) is out of way before raising or lowering bridge.

1. Turn MIX/LIFT SWITCH (13) to "LIFT".
2. Turn MIXER SPEED CONTROL (10) to "MIN" and back up to #5.
3. Turn and hold UP/DOWN SWITCH (14) "UP" to raise or "DOWN" to lower.

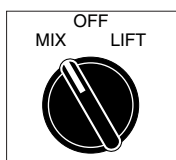
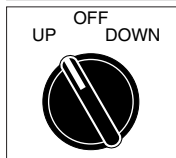
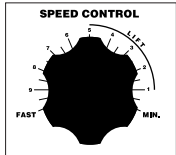

## Mixing

1. Turn MIX/LIFT SWITCH (14) to "MIX".
2. Turn MIXER SPEED CONTROL (10) to "MIN" and slowly adjust to desired speed.
3. Adjust SECONDARY SPEED CONTROL (22) to desired speed.

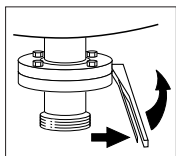
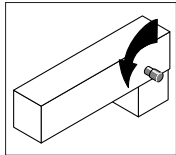
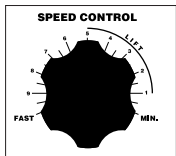

## Discharge Valve

2. Push handle in and pull upwards to open.

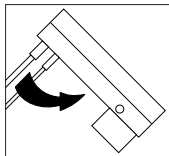

## Tilting Kettle

1. Raise MIXER BRIDGE (18) and swing to side.
2. For **manual tilt**: turn TILT WHEEL (8).
3. For **power tilt**: turn switch "↑" to raise, or "↓" to tilt.

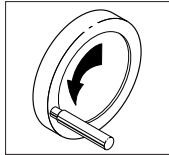

**WARNING-** Do not tilt kettle when mixer agitators are in kettle bowl.

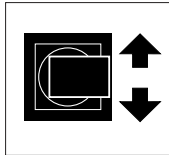

## OPERATING SUGGESTIONS

Cleveland Range Mixer Kettles are simple and safe to operate. The following tips will allow you to maximize the use of your new mixer.

1. Allow unit to preheat before addition of product to kettle. However when cooking egg and milk products, the kettle should NOT be preheated, as products of this nature adhere to hot cooking surfaces. These types of foods should be placed in the kettle before heating is begun.
2. An important part of kettle cleaning is to prevent foods from drying on. For this reason, cleaning should be completed immediately after cooked foods are removed.
3. If a mixer bridge is equipped with a temperature probe for a controller or thermometer, the probe must be submerged a minimum of three inches in the product for accurate readings.

## Safety

1. Close BUTTERFLY VALVE (9) before filling the kettle.
2. When raising or lowering MIXER BRIDGE (18), insure FAUCET SPOUT (15) is not in the way of MAIN AGITATOR ARM (19) or damage to spout will result.
3. As a safety precaution the MIXER SPEED CONTROL (10) must first be turned to zero before unit will start to mix.
4. Always remember, like a cooking pot the kettles become very hot when cooking. Avoid contact with bare skin.

# CLEANING INSTRUCTIONS



## CARE AND CLEANING

Cooking equipment must be cleaned regularly to maintain its fast, efficient cooking performance and to ensure its continued safe, reliable operation. The best time to clean is shortly after each use (allow unit to cool to a safe temperature).

## WARNINGS

- ⇒  Do not use detergents or cleansers that are chloride based or contain quaternary salt.  
**Chloride Cleaners**
- ⇒  Do not use a metal bristle brush or scraper.  
**Wire Brush &**
- ⇒  Steel wool should never be used for cleaning the stainless steel.  
**Steel Pads**
- ⇒  Unit should never be cleaned with a high pressure spray hose.  
**High Pressure Spray Hose**
- ⇒  Do not leave water sitting in unit when not in use.  
**Stagnant Water**

## CLEANING INSTRUCTIONS

1. Turn unit off.
2. Remove drain screen (if applicable). Thoroughly wash and rinse the screen either in a sink or a dishwasher.
3. Prepare a warm water and mild detergent solution in the unit.
4. Remove food soil using a nylon brush.
5. Loosen food which is stuck by allowing it to soak at a low temperature setting.
6. Drain unit.
7. Rinse interior thoroughly.
8. If the unit is equipped with a **Tangent Draw-Off Valve**, clean as follows:
  - a) Disassemble the draw-off valve first by turning the valve knob counter-clockwise, then turning the large hex nut counter-clockwise until the valve stem is free of the valve body.
  - b) In a sink, wash and rinse the inside of the valve body using a nylon brush.
  - c) Use a nylon brush to clean tangent draw-off tube.
  - d) Rinse with fresh water.
  - e) Reassemble the draw-off valve by reversing the procedure for disassembly. The valve's hex nut should be hand tight only.
9. If the unit is equipped with a **Butterfly Valve**, clean as follows:
  - a) Place valve in open position.
  - b) Wash using a warm water and mild detergent solution.
  - c) Remove food deposits using a nylon brush.
  - d) Rinse with fresh water.
  - e) Leave valve open when unit is not in use.
10. Using mild soapy water and a damp sponge, wash the exterior, rinse, and dry.

## NOTES

- ⇒ For more difficult cleaning applications one of the following can be used: alcohol, baking soda, vinegar, or a solution of ammonia in water.
- ⇒ Leave the cover off when the kettle is not in use.
- ⇒ For more detailed instructions refer to the Nafem Stainless Steel Equipment Care and Cleaning manual (supplied with unit).

# STAINLESS STEEL EQUIPMENT CARE AND CLEANING

(Supplied courtesy of Nafem. For more information visit their web site at [www.nafem.org](http://www.nafem.org))

## Contrary to popular belief, stainless steels ARE susceptible to rusting.

Corrosion on metals is everywhere. It is recognized quickly on iron and steel as unsightly yellow/orange rust. Such metals are called "active" because they actively corrode in a natural environment when their atoms combine with oxygen to form rust.

Stainless steels are passive metals because they contain other metals, like chromium, nickel and manganese that stabilize the atoms. 400 series stainless steels are called ferritic, contain chromium, and are magnetic; 300 series stainless steels are called austenitic, contain chromium and nickel; and 200 series stainless, also austenitic, contains manganese, nitrogen and carbon. Austenitic types of stainless are not magnetic, and generally provide greater resistance to corrosion than ferritic types.

With 12-30 percent chromium, an invisible passive film covers the steel's surface acting as a shield against corrosion. As long as the film is intact and not broken or contaminated, the metal is passive and stain-less. If the passive film of stainless steel has been broken, equipment starts to corrode. At its end, it rusts.

## Enemies of Stainless Steel

There are three basic things which can break down stainless steel's passivity layer and allow corrosion to occur.

1. Mechanical abrasion
2. Deposits and water
3. Chlorides

**Mechanical abrasion** means those things that will scratch a steel surface. Steel pads, wire brushes and scrapers are prime examples.

**Water** comes out of the faucet in varying degrees of hardness. Depending on what part of the country you live in, you may have hard or soft water. Hard water may leave spots, and when heated leave deposits behind that if left to sit, will break down the passive layer and rust stainless steel. Other deposits from food preparation and service must be properly removed.

**Chlorides** are found nearly everywhere. They are in water, food and table salt. One of the worst chloride perpetrators can come from household and industrial cleaners.

## So what does all this mean? Don't Despair!

Here are a few steps that can help prevent stainless steel rust.

### 1. Use the proper tools.

When cleaning stainless steel products, use non-abrasive tools. Soft cloths and plastic scouring pads will not harm steel's passive layer. Stainless steel pads also can be used but the scrubbing motion must be in the direction of the manufacturers' polishing marks.

### 2. Clean with the polish lines.

Some stainless steel comes with visible polishing lines or "grain." When visible lines are present, always scrub in a motion parallel to the lines. When the grain cannot be seen, play it safe and use a soft cloth or plastic scouring pad.

### 3. Use alkaline, alkaline chlorinated or non-chloride containing cleaners.

While many traditional cleaners are loaded with chlorides, the industry is providing an ever-increasing choice of non-chloride cleaners. If you are not sure of chloride content in the cleaner used, contact your cleaner supplier. If your present cleaner contains chlorides, ask your supplier if they have an alternative. Avoid cleaners containing quaternary salts; it also can attack stainless steel and cause pitting and rusting.

### 4. Treat your water.

Though this is not always practical, softening hard water can do much

to reduce deposits. There are certain filters that can be installed to remove distasteful and corrosive elements. To insure proper water treatment, call a treatment specialist.

### 5. Keep your food equipment clean.

Use alkaline, alkaline chlorinated or non-chloride cleaners at recommended strength. Clean frequently to avoid build-up of hard, stubborn stains. If you boil water in stainless steel equipment, remember the single most likely cause of damage is chlorides in the water. Heating cleaners that contain chlorides have a similar effect.

### 6. Rinse, rinse, rinse.

If chlorinated cleaners are used, rinse and wipe equipment and supplies dry immediately. The sooner you wipe off standing water, especially when it contains cleaning agents, the better. After wiping equipment down, allow it to air dry; oxygen helps maintain the stainless steel's passivity film.

### 7. Never use hydrochloric acid (muriatic acid) on stainless steel.

### 8. Regularly restore/passivate stainless steel.

## Recommended cleaners for specific situations

Job	Cleaning Agent	Comments
Routine cleaning	Soap, ammonia, detergent, Medallion	Apply with cloth or sponge
Fingerprints & smears	Arcal 20, Lac-O-Nu Ecoshine	Provides barrier film
Stubborn stains & discoloration	Cameo, Talc, Zud, First Impression	Rub in direction of polish lines
Grease & fatty acids, blood, burnt-on-foods	Easy-off, De-Grease It Oven Aid	Excellent removal on all finishes
Grease & oil	Any good commercial detergent	Apply with sponge or cloth
Restoration/Passivation	Benefit, Super Sheen	

## Review

1. Stainless steels rust when passivity (film-shield) breaks down as a result of scrapes, scratches, deposits and chlorides.
2. Stainless steel rust starts with pits and cracks.
3. Use the proper tools. Do not use steel pads, wire brushes or scrapers to clean stainless steel.
4. Use non-chlorinated cleaners at recommended concentrations. Use only chloride-free cleaners.
5. Soften your water. Use filters and softeners whenever possible.
6. Wipe off cleaning agent(s) and standing water as soon as possible. Prolonged contact causes eventual problems.

To learn more about chloride-stress corrosion and how to prevent it, contact the equipment manufacturer or cleaning materials supplier.

Developed by Packer Engineering, Naperville, Ill., an independent testing laboratory.

# MAINTENANCE

## INSPECTION AND MAINTENANCE CHECK LIST

Cleveland Range equipment requires little preventative maintenance. We do however provide the following chart as a guide line for inspection and maintenance to keep your unit functioning at 100%.

### Item Inspection

#### *MONTHLY INSPECTIONS*

---

Switches	Inspect switches for damage and correct operation. Replace as required.
<u>Product Drain Valves</u>	
Butterfly Valve	Inspect parts for damage. Test valve for leakage. Replace as required.
Air Valve	Inspect parts for damage. Test valve for leakage. Check valve seals for air leakage. Inspect supply hose and fittings. Replace as required. Inspect air filter and replace if required.

#### *SIX MONTH MAINTENANCE*

---

Lubrication	Grease trunnion housings and gear/worm assembly as recommended in Lubrication Instructions.  Grease bridge swivel assembly.  Use "Never Seize" on tilt worm and gear.
Kettle Console Cover	Inspect gasket material for integrity. Replace if necessary.  Insure all screws are in place and firmly holding down the cover.  If not replace/tighten screws.
Hand wheel (hand tilt models only)	Check hand wheel for tightness. If loose tighten allen screw.
Tilting (tilting models only)	Check that kettle tilts smoothly. Grease as described in Lubrication Procedure.
On-Off Switch/Temperature Control	Check for damage. Replace if necessary.
Pressure Gauge	Check that the gauge does not have moisture on its inside face. Replace if moisture is present.  Check that the gauge shows a vacuum (needle is well into the Green zone) when cold and shows between 25-40 psi when unit is hot. If not follow Vacuum Leak Test Procedure.
Pressure Relief Valve	Check pressure relief valve as described in Pressure Relief Valve Testing Procedure .
Temperature Check	Following Calibrating Procedure check the inner kettle surface temperature with a digital surface thermometer. Adjust if required.
Gear/Worm Assembly	Inspect for play. Tighten Allen screws if required.

#### *YEARLY MAINTENANCE*

---

Lubrication	Drain hydraulic oil and remove filter. Replace oil and filter (see Hydraulic Oil Replacement Procedure).
Solenoid Valves	Inspect solenoid valves for proper operation. Clean or replace as required.

# Kettle Safety Inspection Checklist

Just recently a competitor's steam jacketed kettle exploded causing serious personal injury and damage to a kitchen. In most cases these accidents are caused by poor maintenance and/or incorrect installation.

We at Cleveland would like to restate that regular inspection and maintenance of units is essential to obtain trouble free and safe operation of equipment. Inspections must include testing of the pressure relief valve and checks of the operating system to insure that it has not been altered.

**No safety features designed into the equipment should ever be tampered with.** Tampering with or bypassing controls is a very dangerous practice and unfortunately we have seen several cases of this. Following is a short list of the most common and the most dangerous alterations performed on kettles.

## SAFETY VALVE:

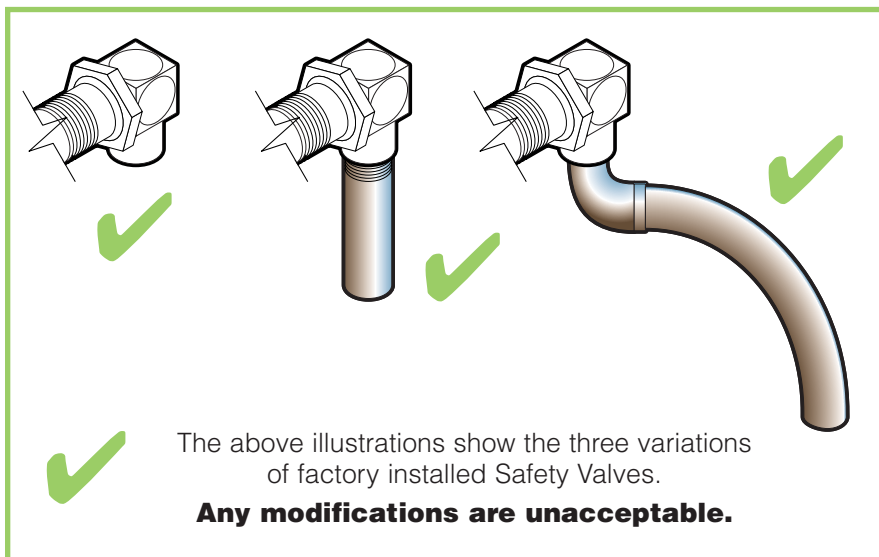

### Incorrect Installations

- 1** Safety valve has plug threaded into the discharge opening preventing any steam from escaping.
- 2** Safety valve's tube diameter has been reduced.
- 3** Safety valve is sticking, frozen shut or plugged. To test, refer to Service Bulletin SE90038 rev. 2, "Pressure Relief Valve Periodic Testing".
- 4** Safety valve is plumbed to a drain or water line creating back pressure and reducing flow.

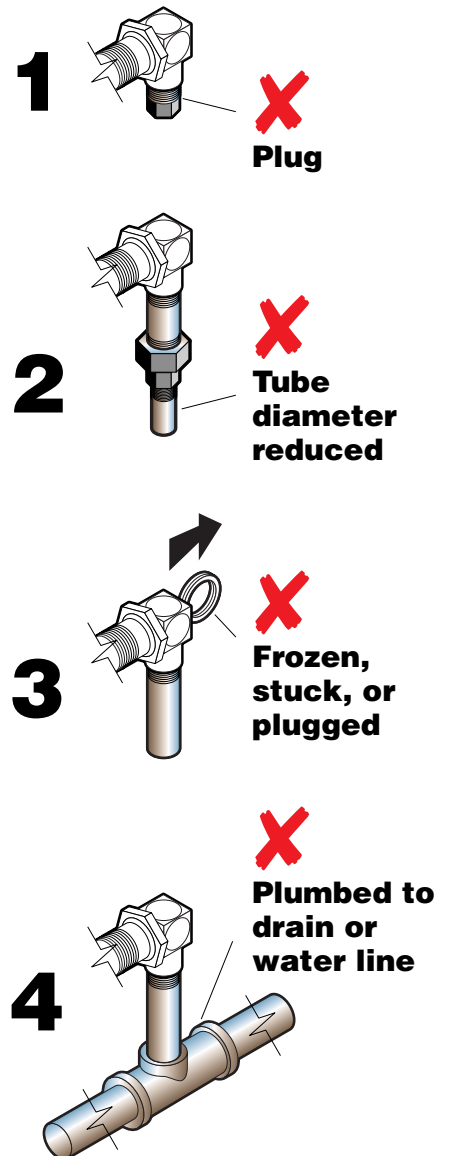

# SAFETY THERMOSTAT:

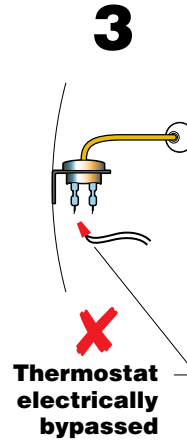
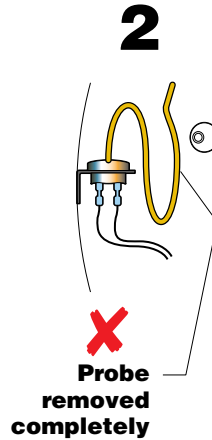
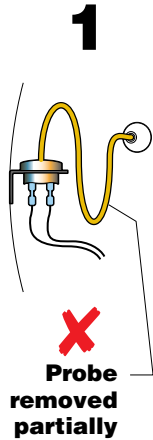
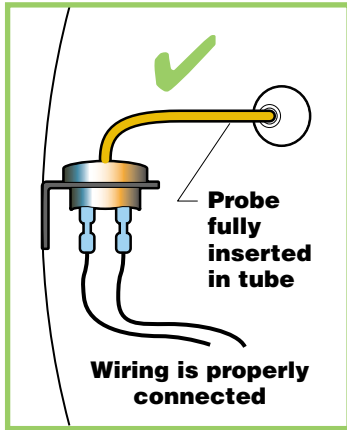

## Incorrect Installations

- 1** Safety thermostat probe is not completely inserted into tubing.
- 2** Safety thermostat probe is removed from tubing.
- 3** Safety thermostat electrical connection is bypassed.

# Low Water Level Probe:

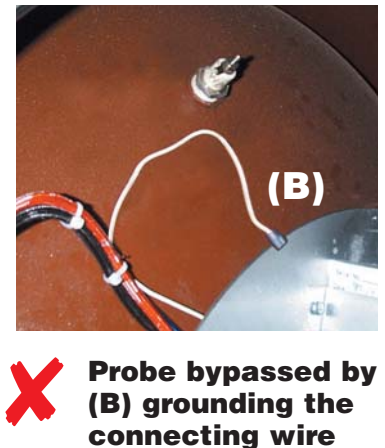
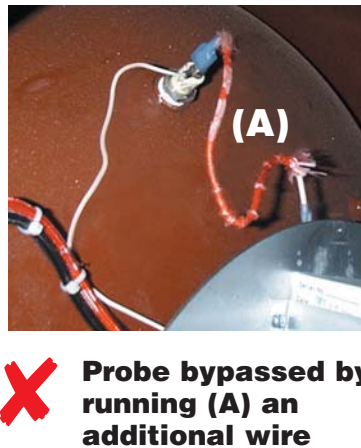

# Operating Thermostat:

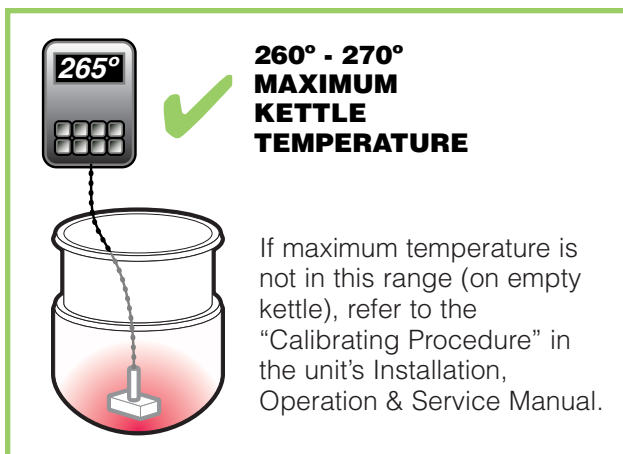

# Gas Kettle Air Switch

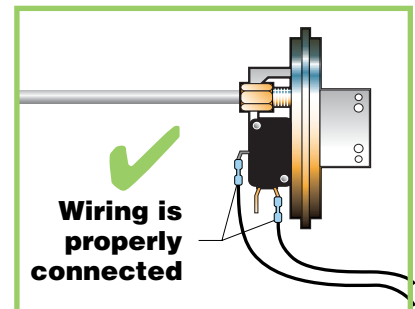

## Incorrect Installation

