

ASSEMBLY INSTRUCTION

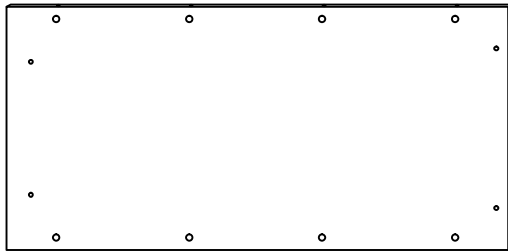

LANCASTER
TABLE & SEATING

PART LIST:



(1) 1PC

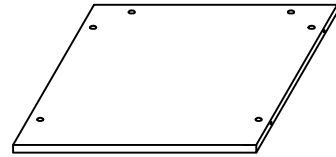

(4) 1PC



(2) 1PC

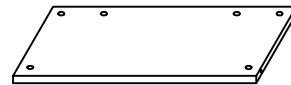

(5) 1PC



(3) 1PC

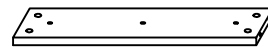

(6) 2PCS

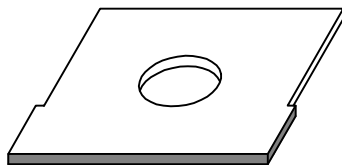





(7) 1PC

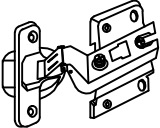
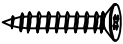

(8) 1PC

HARDWARE LIST:

<p>A</p> 	<p>B</p> 	<p>C</p> 
<p>28PCS</p>	<p>28PCS</p>	<p>3PCS</p>
<p>D</p> 		<p>E</p> 
<p>6PCS</p>		<p>18PCS</p>

Tools required:

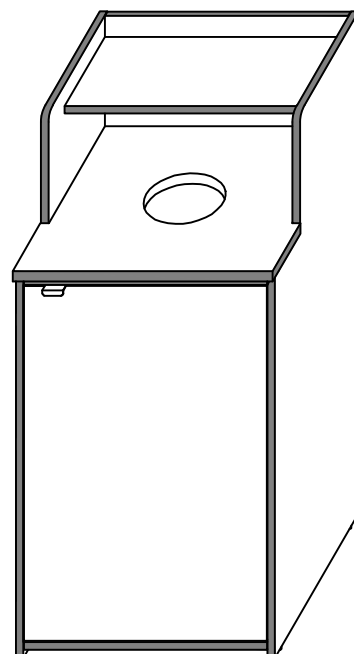
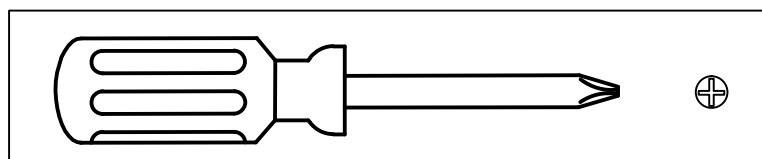

STEP 1.

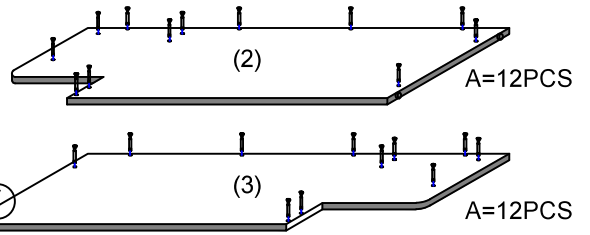
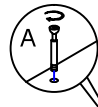
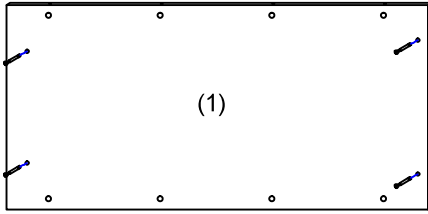

STEP 2.

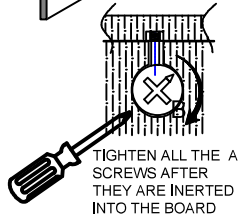
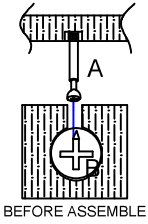
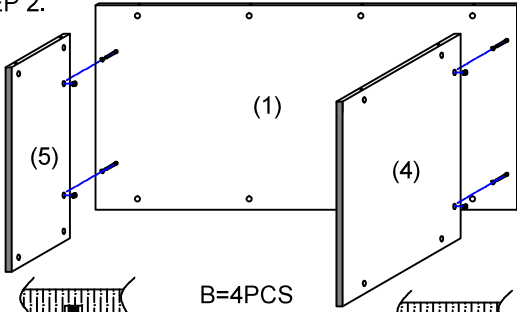

STEP 3.

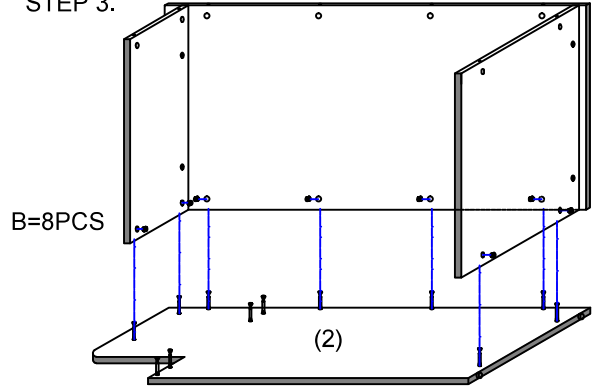

STEP 4.

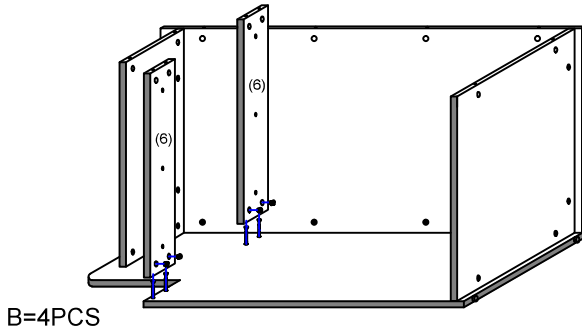

STEP 5.

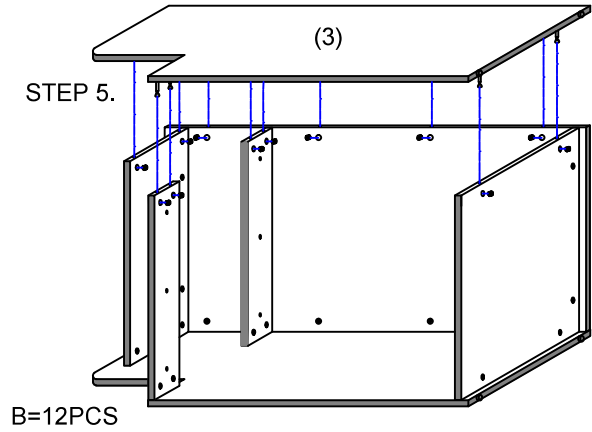

STEP 6.

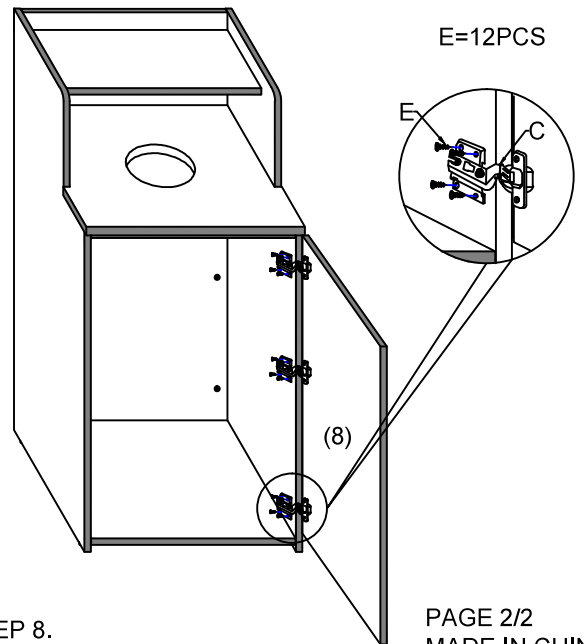
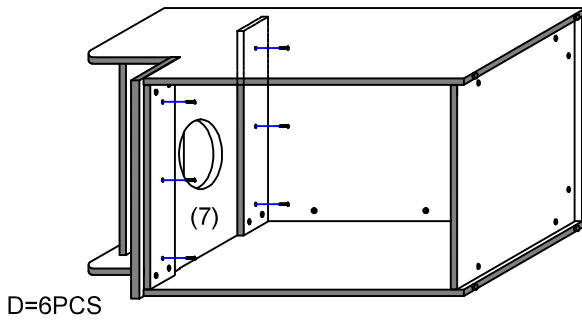

STEP 7.

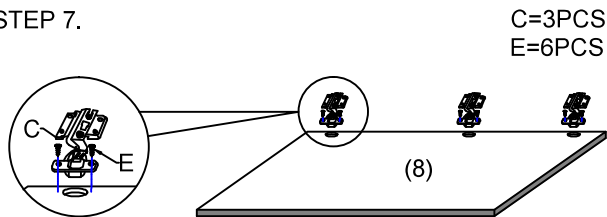

STEP 8.