

OWNER'S MANUAL

CamKiosk®

This manual applies to the following CamKiosk models:

KVC854
KVC854C
KVC854U

KVC856
KVC856C
KVC856U



CAMBRO
MANUFACTURING COMPANY

DURABILITY THAT MAKES A DIFFERENCE®

Table of Contents

Introduction	
Product Overview	2
Assembly	
1. Parts Checklist	3
2. Shelf, Sneeze Guard, and Umbrella Assembly Instructions	4
3. Canopy Assembly Instructions	5
Maintenance and Cleaning and Accessories	6
Replacement Parts	7
Warranty and Service	Back Cover

Introduction

Congratulations on the purchase of your new CamKiosk. We are proud to offer this well-engineered portable foodservice center and expect it to be a source of revenues and profits for you for many years.

This Operator's Manual provides you with a step by step guide to assembling, operating, and maintaining the CamKiosk. If you have any further questions, please do not hesitate to contact your Cambro sales representative, visit our Web Site at www.cambro.com or call our Customer Service Hot Line at 800 833 3003.

CamKiosk

Before you begin, make sure you have the following items:

CamKiosk

- 1 Shelf Section.
- 2 Three Rigid Poles, one 36" x 1½" & two 36" X 1¼" with base unit or four 49" Telescopic Poles and one 36" X 1½" Rigid Pole for units with canopy.
- 3 One clear panel 11¼" X 78¼".
- 4 One clear panel 14½" X 40¾".
- 5 Two pole plugs for rear holes operator side. Base model only.
- 6 One menu board.
- 7 One cash box with 2 keys.
- 8 One cash drawer.

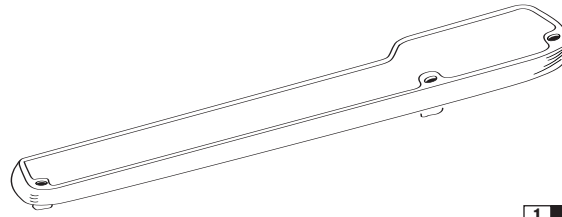

1 SHELF SECTION

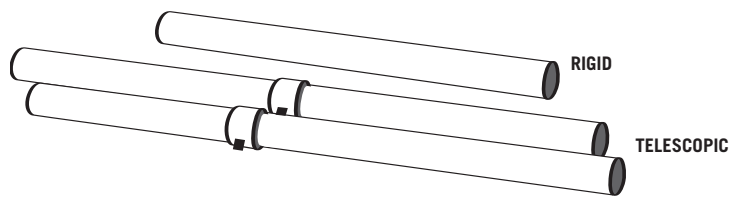

2 POLES

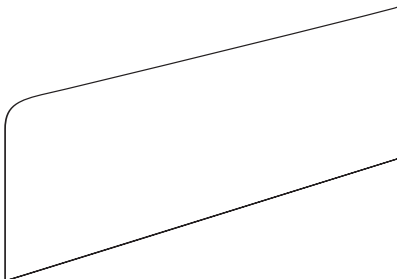

3 CLEAR PANEL

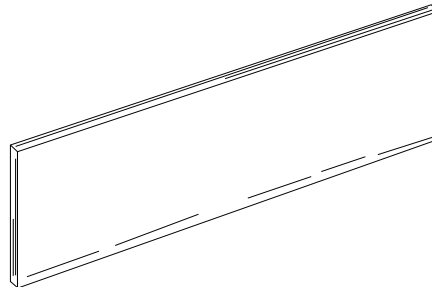

4 CLEAR PANEL

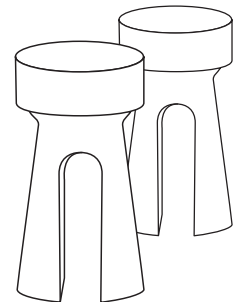

5 POLE PLUGS

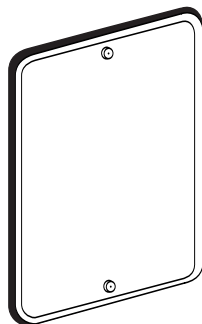

6 MENU BOARD

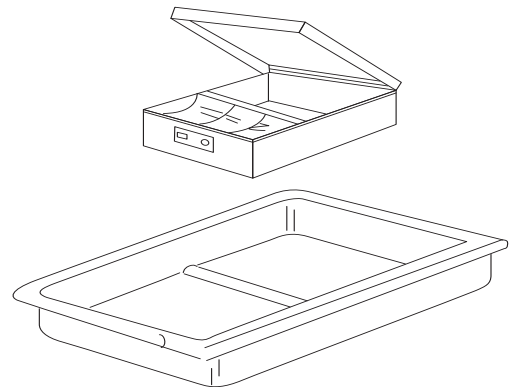

7 **8** CASH BOX & DRAWER

Assembly Instructions

Shelf and Sneeze Guard Only

1. CamKiosk models KVC854, KVC854U, KVC856, and KVC856U include 36" Rigid Poles.
2. Place 36" poles into sockets along the front (customer) side of main body counter. Take note that the center pole is of a larger diameter than the end poles.
3. Set the bottom clear panel (11¼" x 78¾") into the groove along the front edge or customer side of the countertop.
4. Slide shelf section down over poles until shelf rests firmly on clear panel.
5. Tighten thumb screws until shelf has a level appearance. (3 places)
6. Slide the small sneeze guard panel (14½" x 40⅝") over center pole and end pole on narrow side of shelf. Make sure bottom edge of panel fits into groove on shelf.
7. Tighten set screws at the base of each pole.

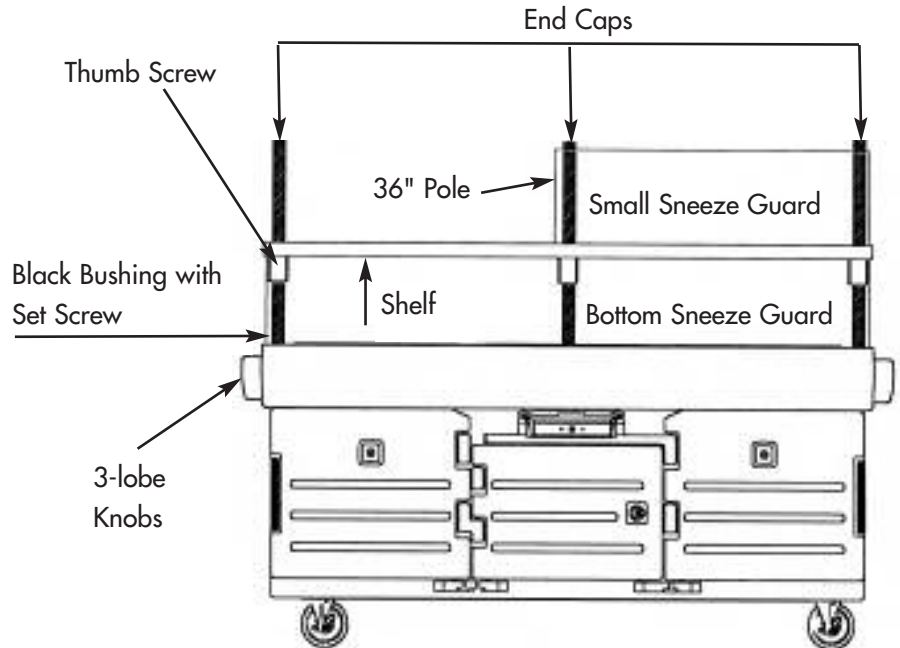

Umbrella Assembly Instructions

Umbrella

- With sneeze guard assembly already in place:
1. Place umbrella into pole.
 2. Let umbrella pole slowly drop into center pole until button snaps into location hole.

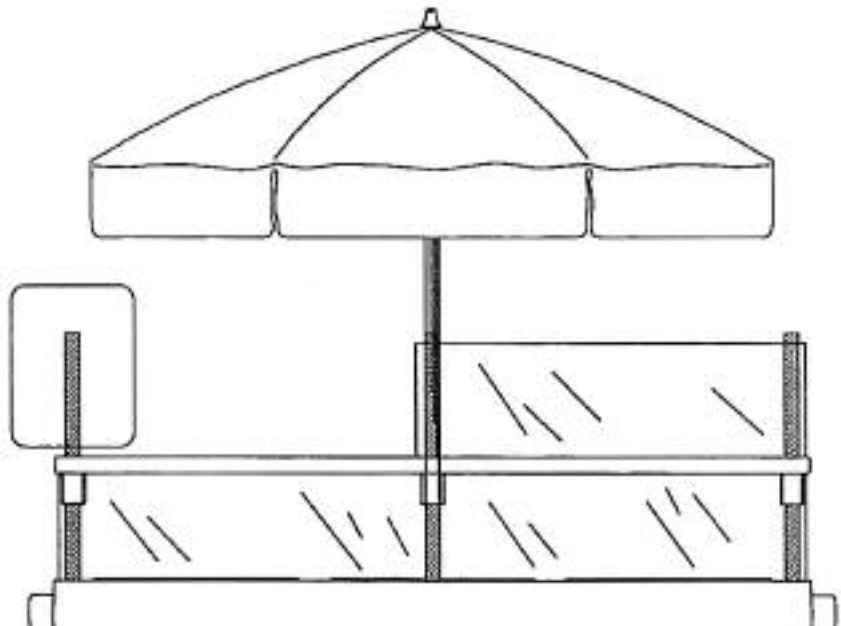

Assembly Instructions

Sneeze Guard and Canopy

1. When canopy is ordered with the vending cart unit (Models KVC854C or KVC856C), sneeze guard end poles as well as poles to the back or operator's side, will be 49" long and telescopic.
2. Place the 36" rigid pole into the center hole on the customer side of the countertop.
3. Set the bottom clear panel (11¼" x 78¾") into the groove along the front edge or customer side of the countertop.
4. Place the shelf section down over the center pole until it is firmly resting on the clear panel below it.
5. Place one of the telescopic poles down through the shelf and into the countertop hole on the end of the shelf where it is wider for serving.
6. Slide the small sneeze guard panel (14½" x 40½") on to the center pole making sure the bottom edge of the panel fits into the groove on the top side.
7. Place the next telescopic pole down through the hole or slot of the top sneeze guard, the shelf, and finally into the hole of the countertop section.
8. Put the remaining two telescopic poles into the two holes on the operator's side.
9. Rotate all 4 poles so that the knobs on the black clamps are facing outward on both ends of the cart. Then tighten the set screws in each black bushing as well as the thumb screws on the shelf section being sure to check that the shelf has a level appearance.
10. Place the canopy on top of the 4 poles and tighten the thumb screws at each corner of the canopy.

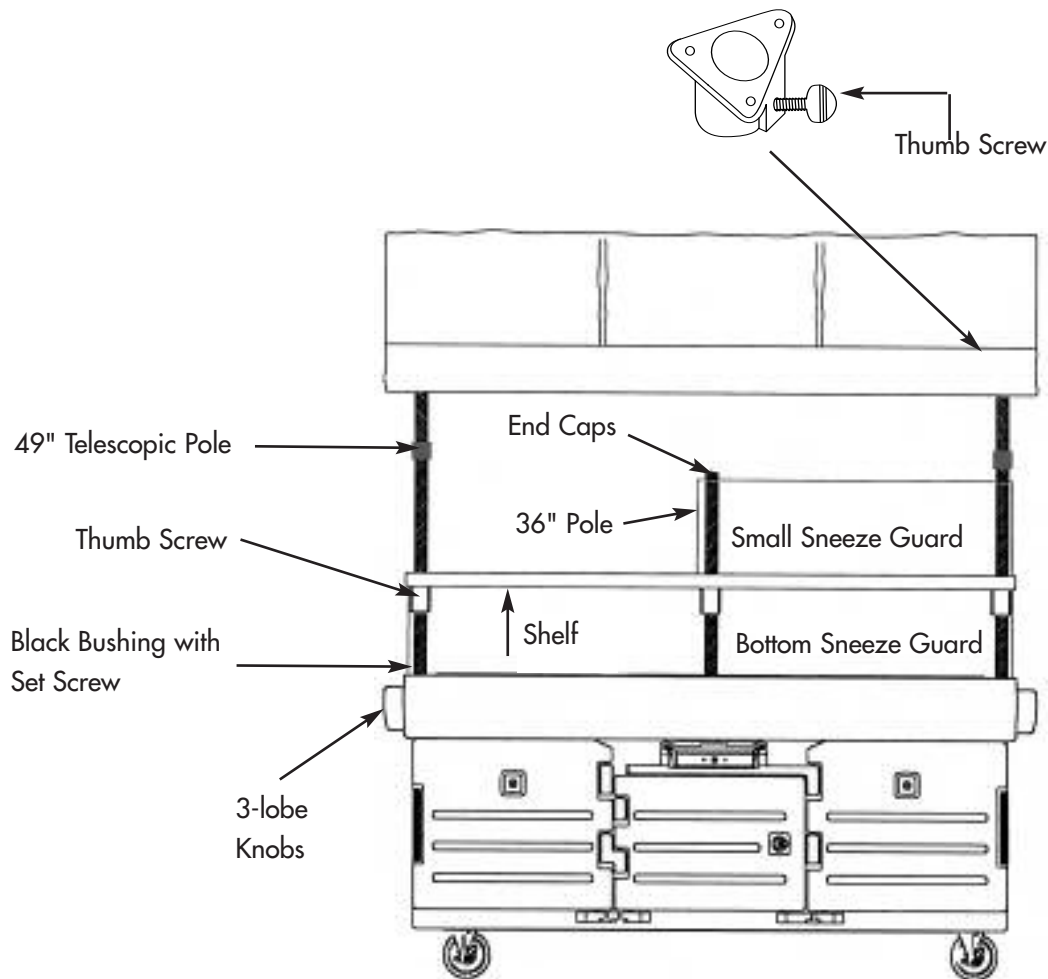

Maintenance and Cleaning and Accessories

General Instructions

The Cambro CamKiosk is designed to be easily serviced and maintained. The CamKiosk should be cleaned regularly. Additionally, it should be cleaned before using if it has been idle for 5 days or more.

CamKiosk Body/Display-Serving Shelf/Holding Compartments

Steam clean or wash with warm soapy water and a soft plastic or bristle brush. **Never use a metal brush or abrasive cleaner.** Scrub with brush, and rinse thoroughly with clean water. If staining occurs, any standard de-stainer such as Ecolab's "Dip It" should be used.

Clear Plastic Sneeze Guard Shield

Wash the clear plastic shield with warm soapy water. Rinse thoroughly. Dry with soft cloth or soft paper towel. **Never use alcohol, i.e. Windex, abrasives, any type of solvent or acetone.** Alcohol based cleaners will cause the shield to crack.

Vinyl Canopy

Spray rinse with water from a hose. Wash with mild detergent and use a sponge or soft brush to remove debris.

Metal Uprights & Frame for Canopy

Clean frame/uprights with a damp cloth and mild soap. Apply car wax to poles to prevent oxidation.

Casters

Caster maintenance should be performed each time the CamKiosk has been washed or steam cleaned.

1. Grease swivel raceway of caster using a lubricant such as Lubriplate #930-AA, Keystone #84EPXLT multi-purpose grease or equivalent. Apply grease using a grease gun with a needle nose adapter or a tube-type applicator such as Sta-lube Moly-graph Assembly Lube. If caster is equipped with a zerk grease fitting, use a standard connector on grease gun. These can be obtained at most auto parts stores.
2. On casters with a nylon bushing at the hub, use a light oil such as WD-40. No lubrication is needed on casters with a bearing hub wheel.
3. Check caster for damage and test caster spin and swivel rotation before returning to service.

Optional Accessories

Hand Sink Cart (110V)	KSC402
Hand Sink Cart (220V)	KSC402220
Bridge Connector	KMC24
Cutting Board	CB1220
Camchiller®	CP1220
Well Cover	WCR1220
ThermoBarrier® Insulated Shelf	1600DIV

Replacement Parts

CamKiosk Main Body

Stock No.	Description	Qty.	Stock No.	Description	Qty.
60033	CASTER 6" SWIVEL W/BRAKE-PLUS BOLTS	KIT	60206	MENU BOARD (14522)	KIT
60034	CASTER 6" SWIVEL-PLUS BOLTS	KIT		W/MOUNT CLIPS 2ea.	
7370*	LEFT DOOR WITH HARDWARE LISTED BELOW	KIT		SCREWS 2ea.	
7372*	RIGHT DOOR WITH HARDWARE LISTED BELOW	KIT		THUMB NUTS 2ea.	
	GASKET 1ea.		47293	POLE MOUNT CLIP	1
	VENT CAP 1ea.		45249	10-24 X 7/8" PAN HEAD SCREW	1
	PIVOT PIN 3ea.		45417	THUMB NUT 10-24 THREADS	1
	BUSHING SLEEVE 1ea.		60330	SLOTTED SET SCREWS 4ea.	KIT
60135	LATCH BLACK NYLON W/SCREWS	KIT		45251 SLOTTED	
60202C	TEMPERATURE GAUGE CELSIUS UNIT	KIT	47283	RIGID CANOPY POLE 49" LENGTH	1
	W/45207 #6 X 1/2" SCREW 2ea.		45244	SPADE THUMB SCREW	1
60202F	TEMPERATURE GAUGE FAHRENHEIT UNIT	KIT	60207	CANOPY BEIGE #522 (14328)	KIT
	W/45207 #6 X 1/2" SCREW 2ea.			W/47283A 49" TELESCOPIC POLES 4ea.	
60203	WIRE & PROBE CLIPS W/SCREWS	3	60208	CANOPY GREEN #562 W/POLES 49" (14329)	KIT
	PROBE CLIP 3ea.			W/47283 A 49" TELESCOPIC POLES 4ea.	
	WIRE CLAMP 3ea.		14330	UMBRELLA 6' DIA. GREEN/BEIGE	1
	10-32 X 3/8" ROUND HD SCREWS 6ea.		H06005	CANOPY-TELESCOPING RETROFIT KIT	KIT
7371*	CENTER DOOR WITH			W/ 49" TELESCOPING POLES	
	HARDWARE LISTED BELOW	KIT		SNEEZE GUARD	
	LATCH SLAM ACTION 1ea.		S06005	TELESCOPIC CANOPY POLE	1
	LATCH MOUNT CLIP 1ea.			49" (AFTER 11/01/06)	
	LATCH COVER PLATE 1ea.				
	ACORN NUT-NYLON 1ea.				
	PIVOT PIN 3ea.				
	1/4" - 20 JAM HEX NUT 2ea.				
	BUSHING 1ea.				
60201	LATCH-SLAM ACTION (42232)	KIT			
	W/MOUNT CLIPS (47284) 2ea.				
60172	LATCH STRIKE PLATE (42221)	KIT			
	W/45204 SCREWS & 45315 STAR WASHERS 2ea.				
47289	SNEEZE GUARD POLES 36" LENGTH	1			
47279	SNEEZE GUARD TOP CLEAR PANEL	1			
47280	SNEEZE GUARD BOTTOM CLEAR PANEL	1			
45242	TOP SHELF THUMB SCREW-NYLON	3			
47292	CENTER POLE TOP END CAP-BLACK	1			
14508	CASH BOX-METAL	1			
14602	CASH DRAWER	1			
60204	DISPLAY BOARD (47327)	KIT			
	W/45212 10-32 X 3/8" SCREWS 4ea.				
	W/45309 FLANGE WASHER 4ea.				
46038	3-LOBE KNOB W/3/16"-18 X 1 1/2" STUD	1			

Top & Front Panel

Stock No.	Description	Qty.
60198	CLAMP SECTION-W/4 ARM KNOBS (2)	KIT
	CLAMP/ROTO PIECE 1ea.	
	4 ARM KNOB W/3/16"-18 THREADS 2ea.	
60199	3 LOBE KNOB 1/4"-20 X 2-1/2" W/WASHERS	KIT
	3 LOBE KNOB 1/4"-20 X 2-1/2" 2ea.	
	1/4" FENDER WASHER S.S. 2ea.	
60200	THUMB SCREWS W/BRACKET STRAP	KIT
	STRAP/BRACKET 1ea.	
	THUMB SCREWS-BLACK KNOB 2ea.	
	1/4" STAR WASHERS 2ea.	
7378	TOP CONNECTOR PANEL	1
7379	FRONT CONNECTOR PANEL	1

* Specify Color, replace * with a color number to complete the code number.

Warranty

Cambro offers a one year warranty on the CamKiosk. In order to activate the warranty, **you must** complete and return the Warranty Registration Card. If you have any questions regarding the warranty, please call Cambro's Customer Service Hot Line 800 833 3003.

Service

If you have any questions regarding the CamKiosk or Hand Sink Cart, please contact your Authorized Cambro Sales Representative or the Cambro Customer Service Hotline 800 833 3003.

TO ORDER REPLACEMENT PARTS:

- Call Cambro Customer Service at 800 854 7631 **or**
- Fax your order to 714 842 3430 **or**
- Call your local Cambro Representative or Distributor