

Metal SlatStrip

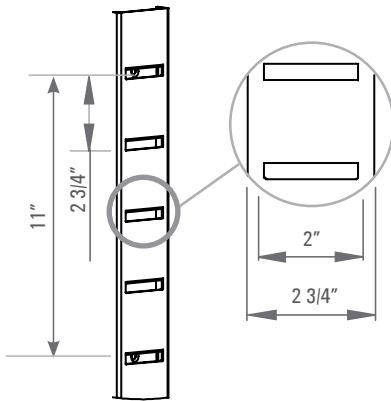
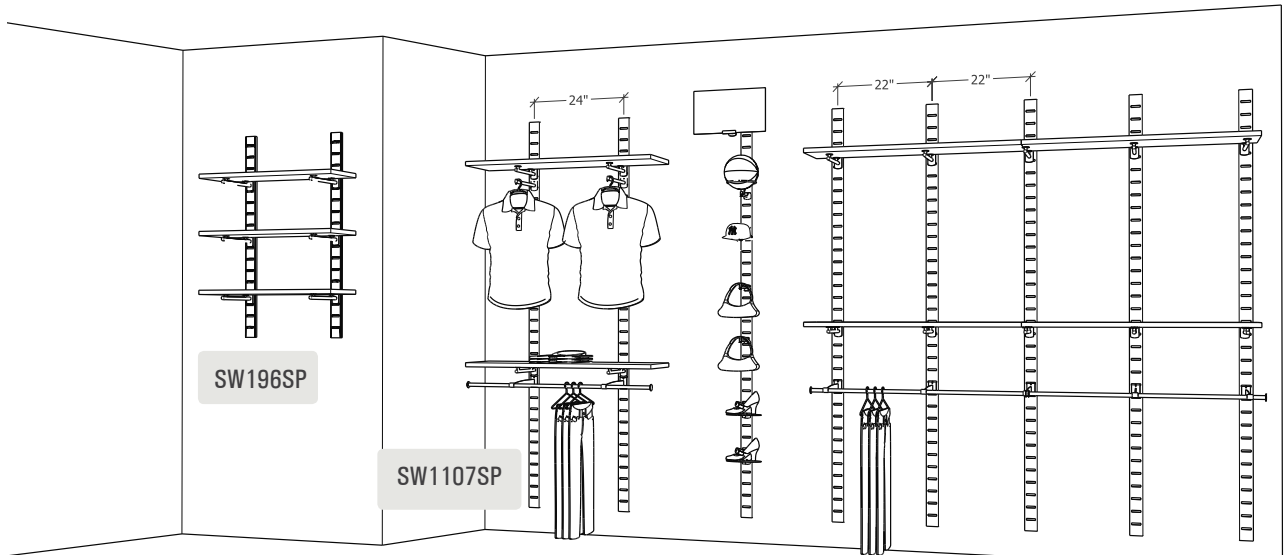

Item #:	SW196SP	SW1107SP
Length:	47"	91"
# of Slits:	17	32
Max Weigh Load*		
Per Strip:	260lbs	520lbs
Per Slit:	88lbs	88lbs

*The weight refers to the SlatStrip's ability to support a certain weight load. The final result depends on the type of wall, anchor, hardware and installation.

Maximum Weight Load (lbs)

		L - Shelf/Bar Width							
		24"		36"		48"			
		Distance Between Supports (Ls)							
Shelf Type	Thickness	20"	22"	22"	24"	32"	22"	24"	36"
Tempered Glass	1/4"	42				22			22
	5/16"	70	66	66	66	38	99	44	38
Glass	3/8"	80*				85			85
MDF	3/4"	30	40	40	40	18	50	25	18
Hanging Bar			77	120	60		31	66	

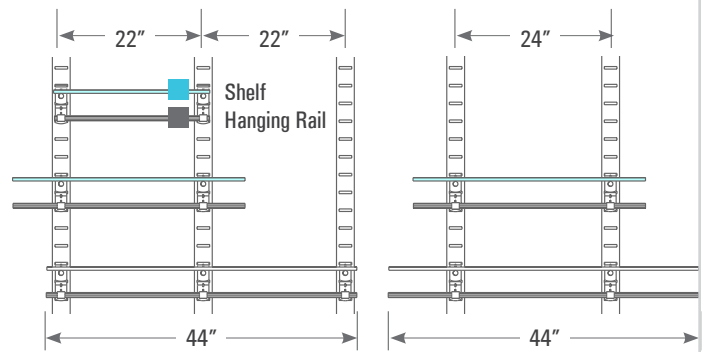

The maximum weight load is based on an evenly distributed weight load between 2 points
 The maximum weight load for regular glass is approximately 1/4 of tempered glass

Please Note:

For mounting on sheet rock/drywall, we recommend using 3/16" Molly Bolts or Toggle Bolts. Tools and mounting hardware are not provided

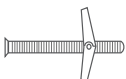

Toggle Bolts



Molly Bolts

Recommended Hardware



Phillips Screw Driver



Screwdriver



Level

Metal SlatStrip

Wall Preparation and Installation

1 Mark on the wall the SlatStrip connection points based on the setting calculation on Page 3.

- The points are from the center of each strip
- The strips should be installed 8" above the floor, in heavy duty setting place the SlatStrip directly on the floor
- Allow 12" from wall edge to strip edge - *in frontal hanging/clothing setting only
- Use a level to ensure accurate vertical positioning

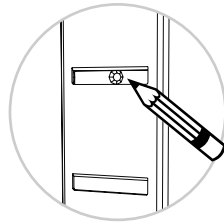

Mark according to the holes in the slots for the screws - 9 holes

For Single SlatStrip

For Multiple SlatStrips

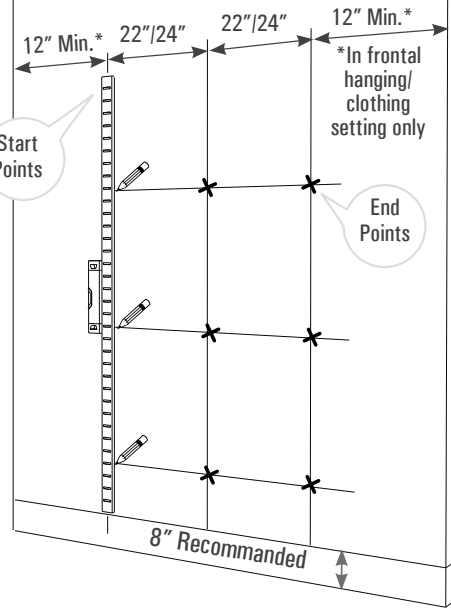

2 Ensure that the bend in the slit face upwards

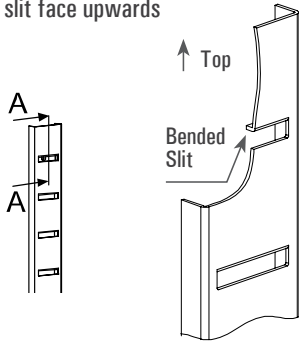

5 Install the rest of the strips as marked in Step 1. Ensure that slits of all strips are parallel to one another

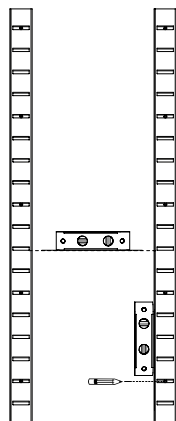

7 Secure wood shelf to shelf bracket with 4 screws

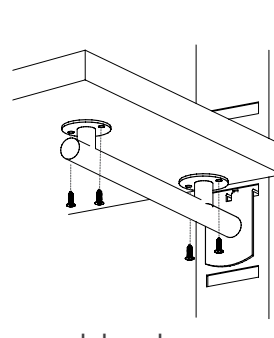

Recommended wood screws, round head, #8 x 5/8"

9 You can create the long strip by using 2 of the 47" Slatstrip, add one on top of each other.

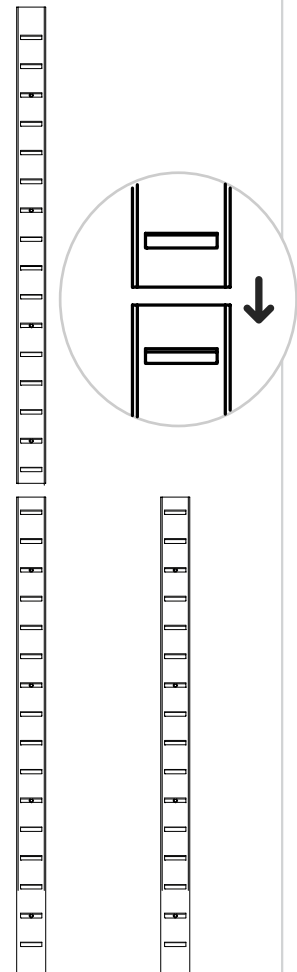

3 Drill holes and apply anchors. Use appropriate fastening hardware for the wall type

For mounting on sheet rock/drywall, we recommend using 3/16" Molly Bolts or Toggle Bolts.

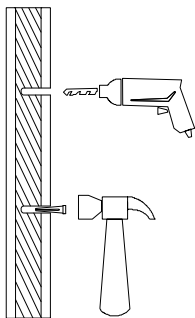

6 Allow 1/2" from the SlatStrip to shelf, in order to be able to change the shelf location as needed

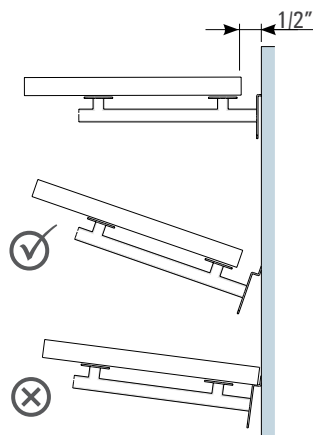

8 Unscrew the stopper, insert the hangrail into the bracket. Tighten with Allen Key to lock in place, then screw stopper back into place.

Tighten with Allen Key to lock in place, then screw stopper back into place.

Insert the hangrail into the bracket. Tighten with Allen Key to lock in place, then screw stopper back into place.

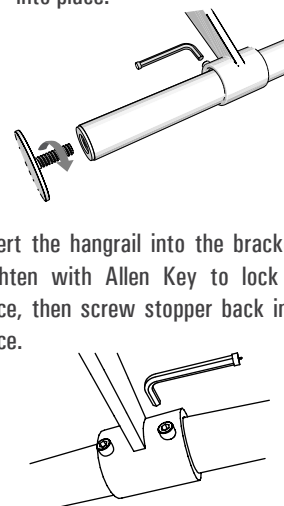

4 Mount strip to the wall using screws with a maximum of 11/32" head diameter

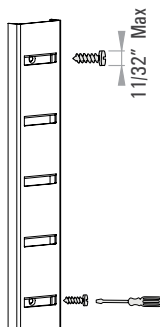

Metal SlatStrip

Calculations for Multiple SlatStrips

Select required your setting from below. Check suitable brackets for each setting.

Note: W = Distance between SlatStrips - (Maximum recommended distance between SlatStrips is 36" due to shelf weight load limits)
A = Shelf Width

1

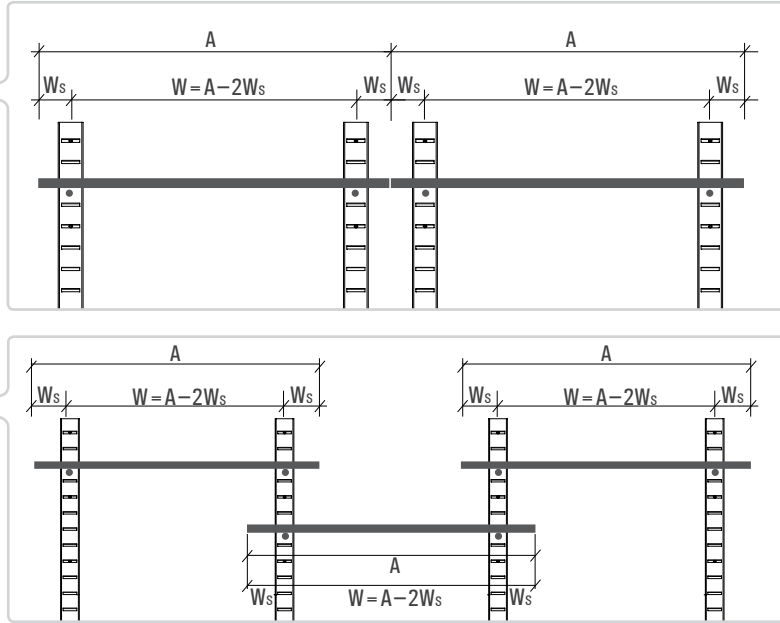
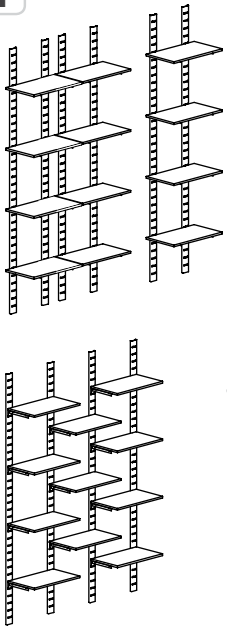

Bracket Types



Glass Shelf Bracket



Heavy Duty Bracket



Wood Shelf Bracket



Hang Rail Bracket

2

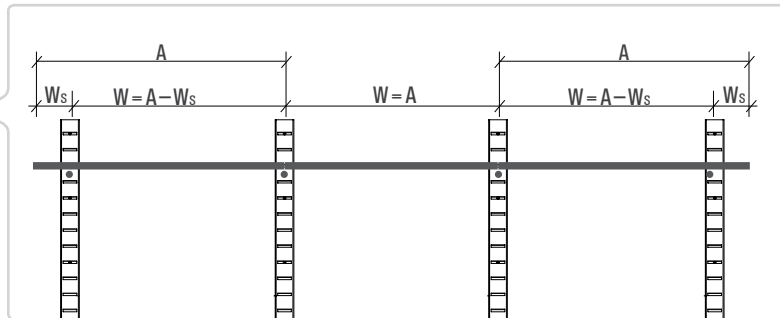
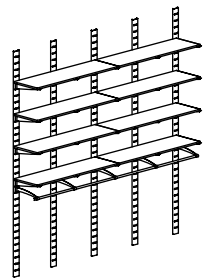

Bracket Types



Heavy Duty Bracket

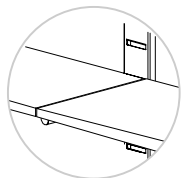

Hang Rail Bracket

3

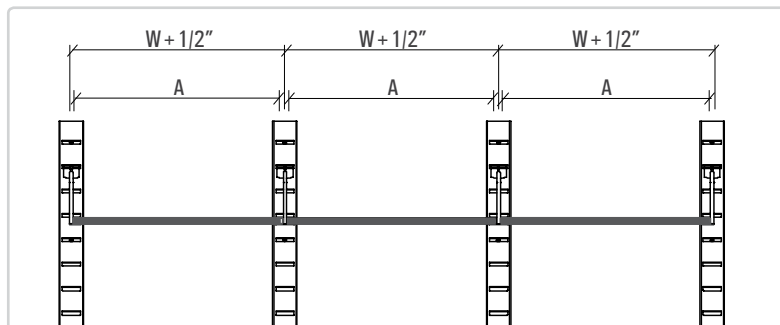
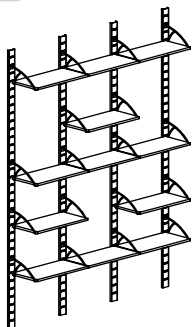

Bracket Types



Decorative Bracket

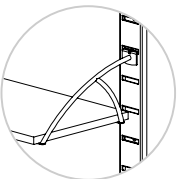

Decorative Bracket