

WARING COMMERCIAL®

BB185

44 oz. polycarbonate container

BB185S

32 oz. stainless steel container

NDG185 / Next Day Gourmet

44 oz. polycarbonate container



027618
Name Plate Label

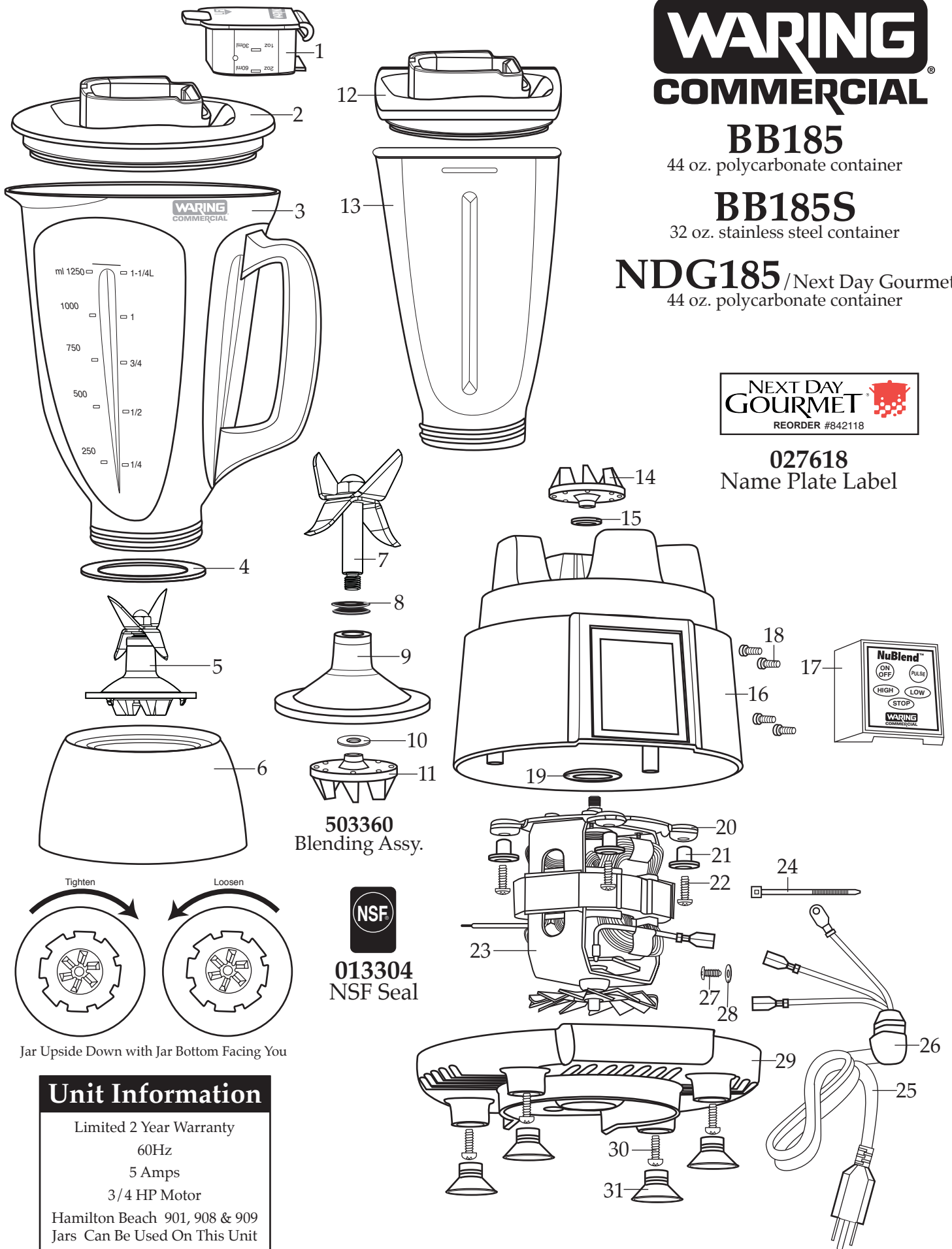

503360
Blending Assy.



013304
NSF Seal

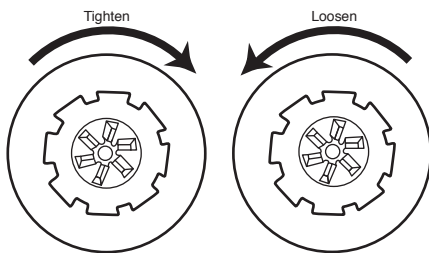

Jar Upside Down with Jar Bottom Facing You

Unit Information

Limited 2 Year Warranty

60Hz

5 Amps

3/4 HP Motor

Hamilton Beach 901, 908 & 909
Jars Can Be Used On This Unit

Catalog#**Model**

BB185 BB185 BB185 MT (Type 25) BB185T BB185
(current & 4th generation) (3rd generation)

BB185S BB185S BB185S MT (Type 25)
(current & 4th generation) (3rd generation)

NDG185 same as BB185 BB185 MT (Type 25)
(current & 4th generation) (3rd generation)



Illustration #	Part #	Description
1	026282	Cover Lid
2	026281	Jar Lid
3	026280	Jar /44 oz. - 5 1/2 cups
4	026284	Jar Seal
5	503360	Blending Assy.
6	026285	Jar Bottom
7	503354	Blade & Shaft Assy.
8	027716	V Seal
9	030427	Bearing Holder
10	030426	Washer / stainless steel
11	027097	Clutch
12	026852	Jar Cover
13	026851	Jar /32 oz. stainless steel
14	027097	Clutch
15	003507	Washer
16	028212	Top Housing
17	026266	Control Module Panel
18	026267	Screw 4 Req.'d
19	026269	Upper Motor Mount
20	026841	Rubber Bushing 4 Req.'d
21	026690	Eyelet 4 Req.'d
22	026716	Screw 4 Req.'d
23	029794	ECM Motor
	027380	ECM Motor <i>(3rd, 2nd generation & older units)</i>
24	013731	Cable Tie 2 Req.'d <i>(current production, 4th & 3rd generation)</i>
25	502835	Cord Set
	502923	Cord Set / with flag terminal <i>(older units)</i>
26	013680	Strain Relief
27	027278	Screw / ground
	002436	Screw / ground <i>(older units)</i>
28	002943	Lock Washer

Catalog#

Model

BB185	BB185 <i>(current & 4th generation)</i>	BB185 MT (Type 25) <i>(3rd generation)</i>	BB185T	BB185
BB185S	BB185S <i>(current & 4th generation)</i>	BB185S MT (Type 25) <i>(3rd generation)</i>		
NDG185	same as BB185 <i>(current & 4th generation)</i>	BB185 MT (Type 25) <i>(3rd generation)</i>		

Waring Factory Service Center
 314 Ella T. Grasso Ave.
 Torrington, CT 06790
 Tele. 1-800-269-6640
 Fax 860-496-9017
 www.waringproducts.com

Illustration #	Part #	Description
29	028580-x	Bottom Housing
	026464	Bottom Housing <i>(2nd generation)</i>
	027063	Bottom Housing / with hole for reset switch <i>(older units)</i>
	502919	Bottom Housing with Reset Switch Assy. <i>(older units)</i>
30	026276	Screw 4 Req.'d
31	026278	Suction Cup Foot 4 Req.'d

Parts No Longer Used *(limited availability)*

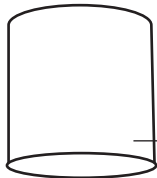

027053 - Shroud (baffle) *(3rd & 2nd generation)*
 026669 - Shroud (baffle) *(older units)*

Used with 027380 motor



502924 - Brown Lead Assy. *(older units)*

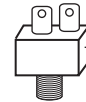

027052 - Reset Switch *(older units)*



014604 - Lock Washer *(older units)*



015184 - Hex Nut *(older units)*

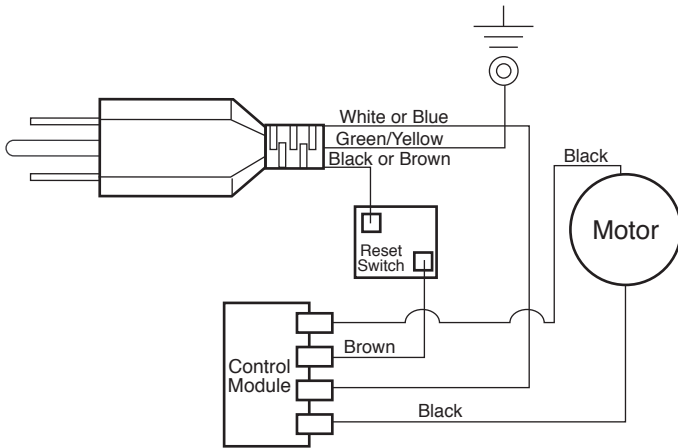

Wiring Diagram

(older units with reset switch)

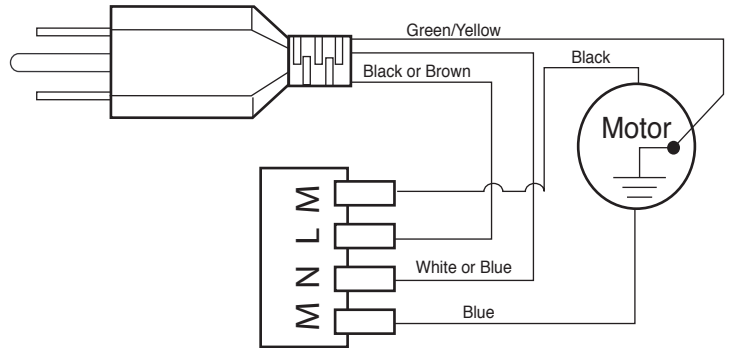

Wiring Diagram

(current production, 4th & 3rd generation)

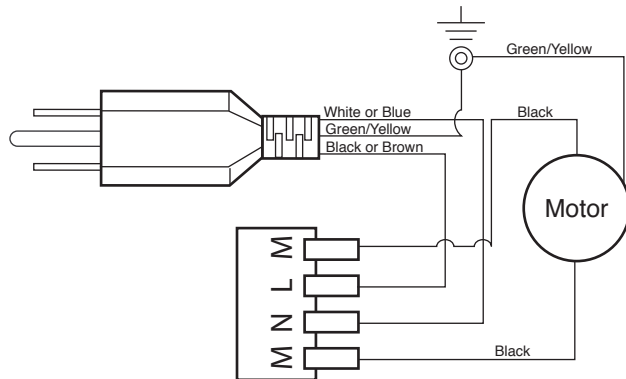

Wiring Diagram

(2nd generation)