

PW-106 HYDRO-SURGE WASHING UNIT

PW-106 HYDRO-SURGE WASHING UNIT



Wells PW-106 Hydro-Surge Washing Unit makes clean up in the kitchen easier with its 1/3 h.p. motor that circulates 500 gallons of water per minute. It also simplifies the cleaning of vegetables, fruit and seafood, all without the need for plumbing connections.

Specifications

Dimensions:	Inches	MM
Overall Motor Length	11 1/2	290
Water Circulation:	500 gallons per minute	
Motor Horsepower:	1/3 hp	
Weights:	Lbs.	KG
Installed	41	19
Shipping	37	17

Features

- Cleans soiled pots and pans with a **powerful "figure 8" pattern water flow** for maximum cleaning with minimal effort.
- Circulates water at **500 gallons per minute** with a motor speed of **1725 R.P.M.**
- Pump housing and removable intake screen are **stainless steel**.
- Impeller is composed of **non-corrosive nickel-steel alloy**.
- All bearings are permanently sealed and **do not require lubrication**.
- Motor is equipped with an **automatic overload protector** to help prevent burnout.
- Power-on is activated by a **toggle switch** located on the motor.
- The PW-106 Hydro-Surge Washing Unit is **Underwriters Laboratories, Inc. LISTED**.
- **A one-year warranty** against defects covers parts and labor.





LISTED
E27255

**MODEL
PW-106
HYDRO-SURGE WASHING UNIT**

DIMENSIONS: $\frac{\text{INCH}}{\text{(MM)}}$

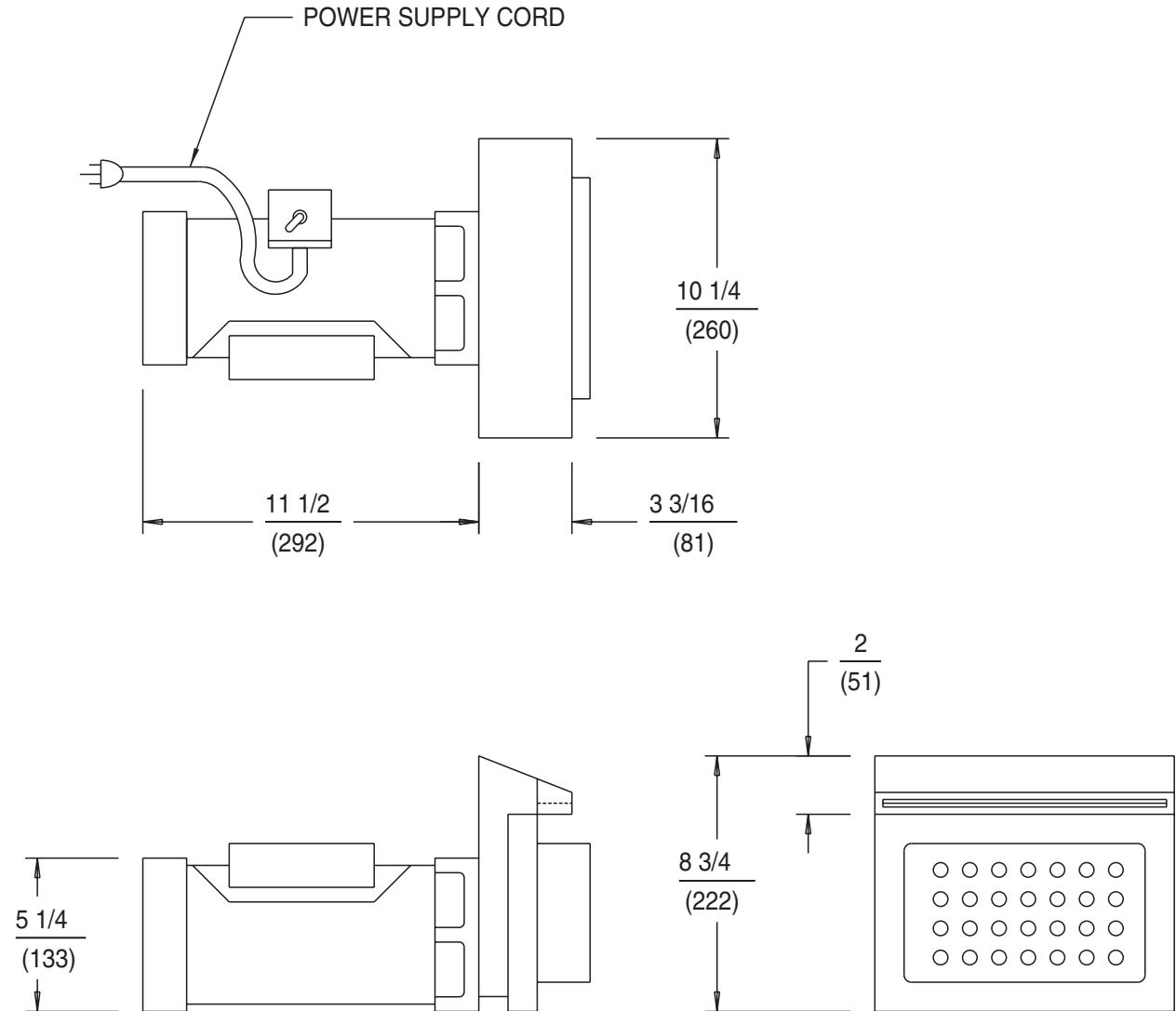

PW-106 ELECTRICAL SPECIFICATIONS:

MODEL	VOLTS	MOTOR H/P	AMPS	POWER SUPPLY CORD
PW-106	120	1/3	6.0	NEMA 5-15P

NOTE: Specifications are subject to change without notice.

WELLS MANUFACTURING COMPANY
2 ERIK CIRCLE, PO BOX 280, VERDI, NV 89439 U.S.A.
USA PHONE: (775) 345-0444 • FAX: (775) 345-0569
FOR ORDERS ONLY: (888) 356-5362 • FAX: (800) 356-5142
www.wells-mfg.com
© 2002 WELLS MANUFACTURING • PRINTED IN THE U.S.A.
08/02 • REV(H) • PART NO. 37102

