

SCOTSMAN

UNDERCOUNTER COMPACT CUBER WITH STORAGE

SCE275

VOLUME PRODUCTION • 24 HOUR



 Certified & rated in accordance with ARI standard 810-95	Air-Cooled		Water-Cooled	
	70°/50° lbs./kg.	ARI 90°/70° lbs./kg..	70°/50° lbs./kg.	ARI 90°/70° lbs./kg.
SCE275-1	290/132	220/100	305/138	264/120
SCE275-32	290/132	220/100	305/138	264/120

DEPENDABLE PERFORMANCE IN ANY CONDITION:

- 90 lbs. of storage.
- Breathes in and out the front side. No need to allow space at its side for air circulation.
- Refrigeration system, electronic control, water pump motor and water valve separated from the ice and water.
- Factory installed photoelectric eye bin control simplifies installation and maximizes ice in the bin.
- Solid state, microprocessor electronic control.
- Reusable, cleanable air filter.
- 7 ft. powercord for quick installation.

WARRANTY *See your dealer for complete warranty details.*

- 3 years parts and labor on all components.
- 5 years parts and labor on evaporator.
- 5 years parts on the compressor and condenser.



UNDERCOUNTER INSTALLATION

Adapts to numerous under-counter applications. Fits under any 40" counter.

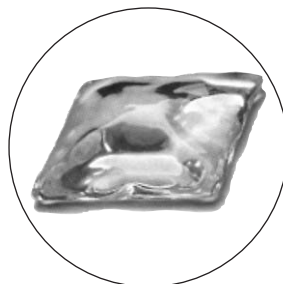

APPROX. CUBE SIZE:

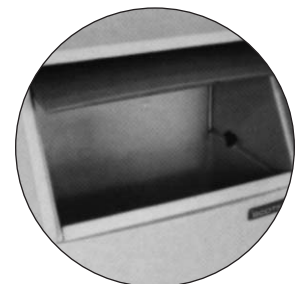

1³/₈" x 1³/₈" x 5/₈"



SLIDE AWAY ACCESS DOOR

Provides convenient and easy access to ice.

CERTIFIED
ISO
9001:2000

This product qualifies for the following listings:

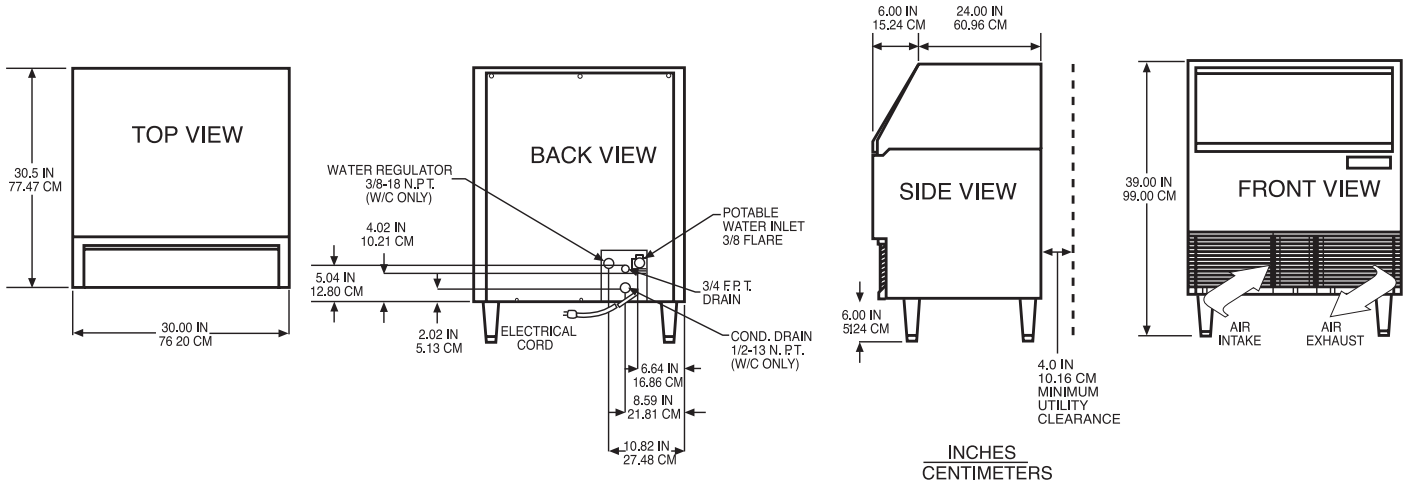

 Rated in accordance with ARI standard 810-95 & 820-95

 **Scotsman**[®]

Ice Machine Specifications



INSTALLATION NOTE: Allow 6" minimum space at back for utility connections.

All models: Dimensions W x D x H without legs (Add 6" height for legs): Unit: 30" x 30" x 33" Shipping Carton: 33" x 33" x 39"												
Model Number	Condenser Unit	Bin* Capacity lbs./kg.	Basic Electrical Volts/Hz/Phase	Max. Fuse Size or HACR Circuit Breaker	Comp. HP	Circuit Wires	Min. Circuit Ampacity	Shipping Weight lbs./kg.	Power Consumption KWH/100 lbs. 90°F/70° F	Water Usage Gallons/100 lbs.		
										Potable 90°F/70° F	Condenser 90°F/70° F	
SCE275A-1G	AIR	90/41	115/60/1	15	.6	2	CORD	230/104	11.4	29.0	-	
SCE275A-32G	AIR	90/41	208-230/60/1	15	.6	2	CORD	230/104	11.4	29.0	-	
SCE275W-1G	WATER	90/41	115/60/1	15	.6	2	CORD	225/102	8.2	28.0	240	

*Bin capacity rated in accordance with ARI Standard 820-95.

Finish: rotocast grey plastic.
Refrigerant-R-404A

LEGS SUPPLIED:
Four plastic legs screw into mounting plates on cabinet base. Provides 6" minimum height.

Scotsman's ice machines are not designed for outdoor installations. Scotsman remote condensers are designed for outdoor installations.

Machine requires voltage indicated on rating name plate. Failures caused by improper voltage are not considered factory defects. Extended periods of operation at temperatures exceeding limitations constitutes misuse under the terms of Scotsman Manufacturer's Limited Warranty, resulting in a loss of warranty coverage. Specifications and design are subject to change without notice.

Consult Your Local SCOTSMAN Representative At:

IMPORTANT OPERATING REQUIREMENTS:

	Minimum	Maximum
Air Temperatures	50°F (10°C)	100°F (37.7°C)
Water Temperatures	40°F (4.4°C)	100°F (37.7°C)
Water Pressures	20 PSIG	120 PSIG
Electrical Voltage	-5%	+10%

YOU'LL VALUE THE DIFFERENCE™

775 Corporate Woods Parkway • Vernon Hills, IL 60061 • 1-800-SCOTSMAN • Fax: (847) 913-9844
Visit our website at: www.scotsman-ice.com • E-mail: customer.service@scotsman-ice.com

