

robot coupe

"The Inventor & World Leader in Food Processors"

"Series E"

R602X

Commercial Food Processor

Continuous Feed Vegetable Prep



- **2.5 HP, direct-drive, single phase, fan-cooled motor with magnetic safety switch. Push buttons for "on-off".**
- **Operates on standard 120V/60HZ/15 AMP power outlet.**
- **Two feed openings to accommodate large bulker produce or smaller delicate produce.**
- **Attachments easily removed for assured cleaning.**
- **Standard model includes two processing discs: 28064 - 3mm (1/8") Slicing and 28058 - 3mm (1/8") Grating.**
- **Complete selection of 38 discs available.**
- **Unit base uses minimal counter space (14 1/4" x 14 3/4").**
- **1 year parts and labor warranty.**

Prepare 2000 servings in 3 hours

Vegetable prep attachment designed for quality continuous feed: slicing, dicing, shredding, grating, french fry and julienne.



Robot Coupe U.S.A., Inc.

P.O. Box 16625
Jackson, MS 39236-6625
1-800-824-1646 • (601) 898-8411
FAX: (601) 898-9134
www.robotcoupeusa.com
e-mail: info@robotcoupeusa.com

SPECIFICATIONS ON REVERSE SIDE

Specifications

STANDARD MODEL includes motor base unit with continuous feed attachment, one 1/8" (3mm) slicing disc and one 1/8" (3mm) grating disc.

ELECTRICAL REQUIREMENTS: 120V-60 HZ, NEMA 5-15 Plug.

SWITCHING: Control panel with push-type on and off buttons.

MOTOR: 2.5 HP, 850 RPM, direct-drive, fan-cooled, single phase.

WEIGHT: 70 lbs. net, 72 lbs. approximate shipping weight.

OPTIONAL EQUIPMENT: 36 additional processing discs, single or multiple disc racks and/or wall mounted disc rack.

STANDARDS: ETL electrical & sanitation, cETL (Canada)

PROCESSING DISCS		
* For Series D & E machines only		
Slicing Discs 28062 1/32" (1mm) 28063 5/64" (2mm) 28064 1/8" (3mm) 28004 5/32" (4mm) 28128* 3/16" (5mm) 28129* 5/16" (8mm) 28130* 3/8" (10mm) 28131* 9/16" (14mm) 28132* 25/32" (20mm) 28133* 1" (25mm)	Grating Discs 28056 1/16" (1.5mm) 28057 5/64" (2mm) 28058 1/8" (3mm) 28136 5/32" (4mm) 28163 3/16" (5mm) 28164 9/32" (7mm) 28165 11/32" (9mm) 28055 Fine Pulping 28061 Hard Cheese Grate	Julienne Discs 28051 5/64" x 5/64" (2mm x 2mm) 27072 5/64" x 5/32" (2mm x 4mm) 27066 5/64" x 1/4" (2mm x 6mm) 27067 5/64" x 5/16" (2mm x 8mm) 28101 5/64" x 5/16" (3mm x 3mm) 28052 5/32" x 5/32" (4mm x 4mm) 28053 1/4" x 1/4" (6mm x 6mm) 28054 5/16" x 5/16" (8mm x 8mm)
Ripple Cut Slicers 27068 5/64" (2mm) 27069 1/8" (3mm) 27070 3/16" (5mm)	French Fry Kits** 28134* 5/16" (8mm) 28135* 3/8" (10mm)	Dicing Kits 28110 3/16" x 3/16" (5mm x 5mm) 28111 5/16" x 5/16" (8mm x 8mm) 28112 3/8" x 3/8" (10mm x 10mm) 28113 9/16" x 9/16" (14mm x 14mm) 28114 25/32" x 25/32" (20mm x 20mm) 28115 1" x 1" (25mm x 25mm)
	Romaine Lettuce Kit 28133/104031 2"	

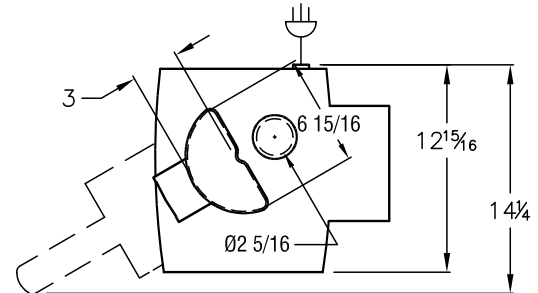
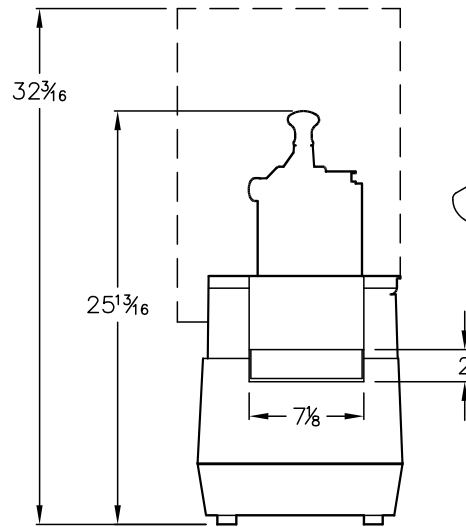
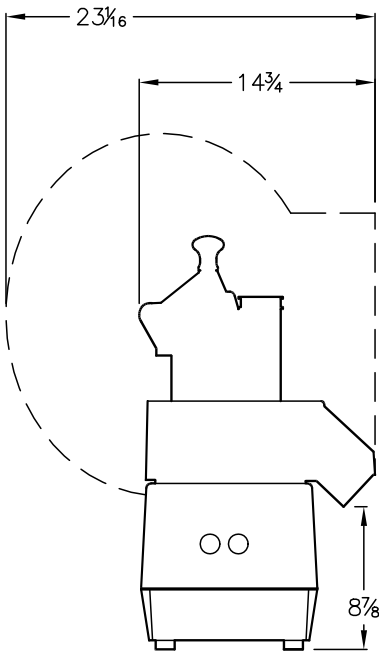

Robot Coupe U.S.A., Inc.
 P.O. Box 16625
 Jackson, MS 39236-6625
 1-800-824-1646
 (601) 898-8411
 FAX: (601) 898-9134
 www.robotcoupeusa.com
 e-mail: info@robotcoupeusa.com

Distributed by: