

# BUNN®

## 12 Cup Automatic Coffee Brewer with 2 Warmers

ITEM#

PROJECT

DATE



### Model OT15

(2 warmers)

(decanter sold separately)

Dimensions: 22.4" H x 12" W x 18.3" D  
(56.9cm H x 30.5cm W x 46.5cm D)

### Features

#### 12 Cup Automatic Coffee Brewer

- Brews 3.8 to 5.1 gallons (14.4 to 19.3 litres) of perfect coffee per hour.
- All stainless steel construction.
- Two separately controlled warmers.
- Faucet kit available.
- SplashGard® funnel deflects hot liquids away from the hand.

For current specification sheets and other information, go to [www.bunn.com](http://www.bunn.com).

### Related Products

#### Easy Clear® EQ-17-TL

Product No. : 30200.1000

Dimensions:

12<sup>7</sup>/<sub>16</sub>" H x 2<sup>1</sup>/<sub>2</sub>" W x 3" D  
31.6 cm H x 6.35 cm W x 7.62 cm D



#### Paper Filter Pack

Product No. : 20115.0000

Packed per case: 1,000

Dimensions: 4<sup>1</sup>/<sub>4</sub>" Base x 2<sup>3</sup>/<sub>4</sub>" Sidewall  
10.8 cm Base x 6.98 cm Sidewall



#### 1GPR SS Portable Server on an RWS1 Warmer

1GPR Product No. : 12487.0001\*

RWS1 Product No. : 12203.0010

\*Also available with side handles or black decor.



#### Easy Clear® ED-17-TL

Product No. : 30201.1001

Dimensions: 8<sup>1</sup>/<sub>4</sub>" H x 2<sup>5</sup>/<sub>16</sub>" Dia.  
20.95 cm H x 5.87 cm Dia.

#### Easy Pour® black decanter

Product No. : 06100.0101

Quantity: 1 (also packaged in quantities of 2, 3, 6, 12, & 24)



#### Easy Pour® orange decanter (for decaf)

Product No. : 06101.0101

Quantity: 1 (also packaged in quantities of 2, 3, 6, 12, & 24)



#### Model

#### Agency Listing

OT15



OT20



## Dimensions & Specifications

Model	Product #	Volts	Amps	Tank Heater Watts	Total Watts	Brewing Capacity	Cu. Ft.	Shipping Weight	Cord Attached
OT 15	20830.0000	120	13	1320	1570	3.8 gal./hr.	4.9	34 lbs.	Yes*
OT 20	20830.0001	120	17	1800	2090	5.1 gal./hr.	4.9	33 lbs.	No

**Brewing capacity:** based upon incoming water temp of 60°F (140°F rise) per 1/2 gallon brew time of 4 minutes.

\*Power cord (NEMA 5-15P) 15 Amp-120V machine only.

Electrical: OT 15 requires 2-wires plus ground service rated 120V, single phase, 60Hz.

OT 20 requires 2-wires plus ground service rated 120V, single phase, 60Hz.

Plumbing: 20-90 psi (138-621 kPa). Supplied with 1/4" OD male flare fitting.

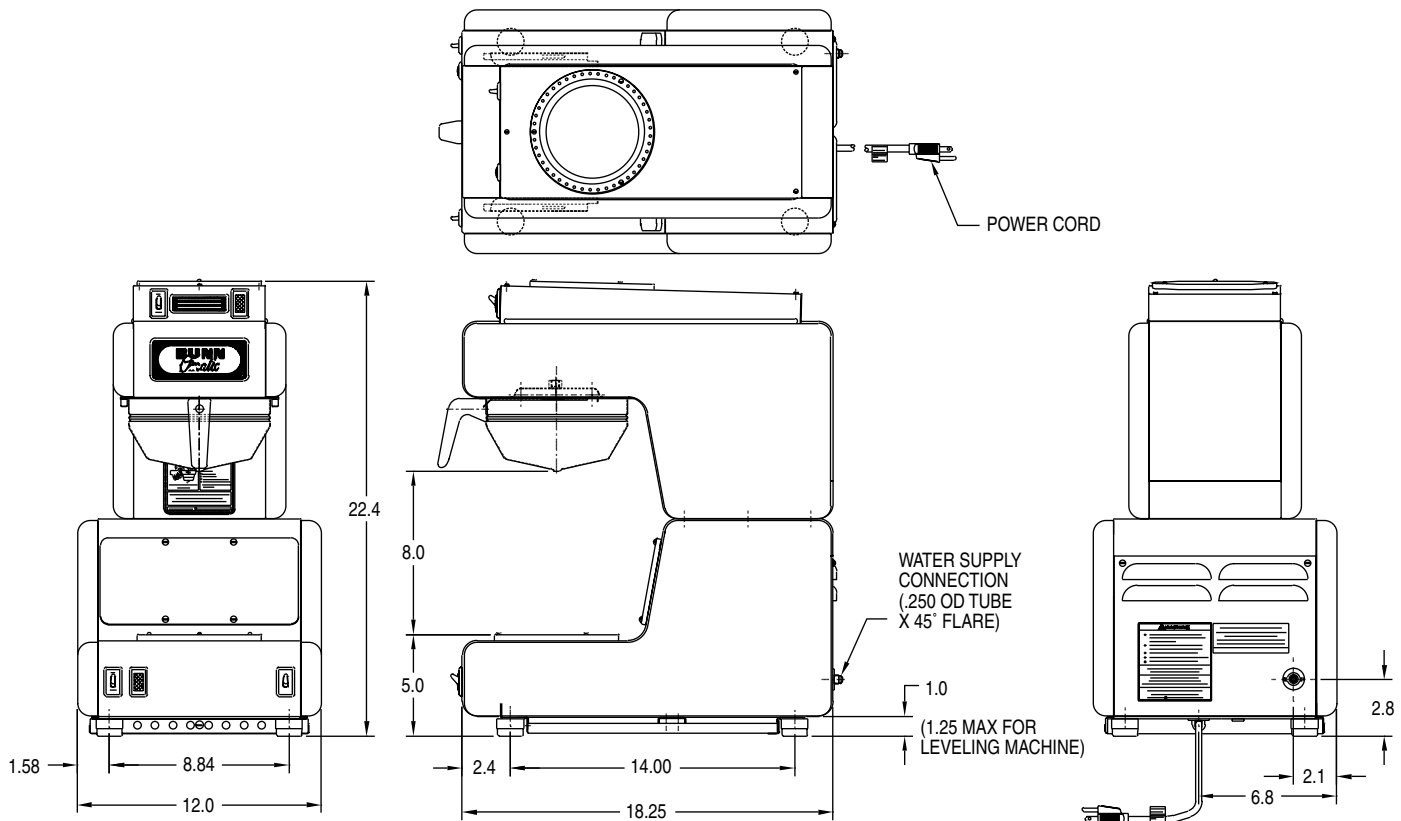

BUNN Corporation - 1400 Stevenson Drive Springfield, Illinois 62703 • 800-637-8606 • 217-529-6601 • Fax 217-529-6644 • www.bunn.com

BUNN® practices continuous product research and improvement. We reserve the right to change specifications and product design without notice. Such revisions do not entitle the buyer to corresponding changes, improvements, additions or replacements for previously purchased equipment.

All dimensions shown in inches. Bunn Corporation owns all copyrights relating to materials in this publication. Please contact Bunn Corporation to request permission to reproduce any portion of this publication.