



**INSTALLATION  
AND  
OPERATING  
INSTRUCTIONS**



# CHDT Series Drop-In Hot & Cold Pans

**Models: CHDT-2, CHDT-3, CHDT-4, CHDT-5 & CHDT-6**

**INTENDED FOR OTHER THAN HOUSEHOLD USE**

**RETAIN THIS MANUAL FOR FUTURE REFERENCE**

### IMPORTANT FOR FUTURE REFERENCE

Please complete this information and retain this manual for the life of the equipment. For Warranty Service and/or Parts, this information is required.

\_\_\_\_\_   
Model Number

\_\_\_\_\_   
Serial Number

\_\_\_\_\_   
Date Purchased



**WARNING:** Improper installation, adjustment, alteration, service or maintenance can cause property damage, injury or death. Read the Installation, Operating and Maintenance Instructions thoroughly before installing or servicing this equipment.



This equipment has been engineered to provide you with year-round dependable service when used according to the instructions in this manual and standard commercial kitchen practices.

Phone: +1 (307) 634-5801  
Fax: +1 (307) 637-8071  
Toll Free: +1 (800) 752-0863  
Website: [www.apwwyott.com](http://www.apwwyott.com)  
E-mail: [info@apwwyott.com](mailto:info@apwwyott.com)

P/N 8802715 11/08

**APW WYOTT**  
P.O. Box 1829  
Cheyenne, WY 82003

**APW Wyott** takes pride in the design and quality of our products. When used as intended and with proper care and maintenance, you will experience years of reliable operation from this equipment. To ensure best results, it is important that you read and follow the instructions in this manual carefully.

Installation and start-up should be performed by a qualified installer who thoroughly read, understands and follows these instruction.



If you have questions concerning the installation, operation, maintenance or service of this product, write Technical Service Department APW/Wyott Foodservice Equipment Company, P.O. Box 1829, Cheyenne, WY 82003.



## SAFETY PRECAUTIONS



Before installing and operating this equipment be sure everyone involved in its operation are fully trained and are aware of all precautions. Accidents and problems can result by a failure to follow fundamental rules and precautions.

The following words and symbols, found in this manual, alert you to hazards to the operator, service personnel or the equipment. The words are defined as follows:



 **DANGER:** This symbol warns of imminent hazard which will result in serious injury or death. 



 **WARNING:** This symbol refers to a potential hazard or unsafe practice, which could result in serious injury or death. 



 **CAUTION:** This symbol refers to a potential hazard or unsafe practice, which may result in minor or moderate injury or product or property damage. 



 **NOTICE:** This symbol refers to information that needs special attention or must be fully understood even though not dangerous. 



---















 **CAUTION:** These models are designed, built, and sold for commercial use. If these models are positioned so the general public can use the equipment make sure that cautions, warnings, and operating instructions are clearly posted near each unit so that anyone using the equipment will use it correctly and not injure themselves or harm the equipment. 

 **WARNING:** Check the data plate on this unit before installation. Connect the unit only to the voltage & frequency listed on the data plate. Connect only to 1 phase with neutral as listed on the data plate. 

 **NOTICE:** The unit when installed, must be electrically grounded and comply with local codes, or in the absence of local codes, with the national electrical code ANSI/NFPA70- latest edition. Canadian installation must comply with CSA-STANDARD C.22.2 Number 0 M1982 General Requirements-Canadian Electrical Code Part II, 109-M1981- Commercial Cooking Appliances. 

 **NOTICE:** Local codes regarding installation vary greatly from one area to another. The National Fire Protection Association, Inc. states in its NFPA96 latest edition that local codes are "Authority Having Jurisdiction" when it comes to requirement for installation of equipment. Therefore, installation should comply with all local codes. 

 **WARNING:** Disconnect device from electrical power supply and place a Tag Out-Lockout on the power plug, indicating that you are working on the circuit. 

	<b>WARNING:</b> Install per the spacing requirements listed in the installation section of this manual. We strongly recommend having a competent professional install the equipment. A licensed electrician should make the electrical connections and connect power to the unit. Local codes should always be used when connecting these units to electrical power. In the absence of local codes, use the latest version of the National Electrical Code.	
	<b>CAUTION:</b> Maintenance & repair should be handled by a factory authorized agent. Before doing any maintenance or repair, contact APW Wyott.	
	<b>WARNING: SHOCK HAZARD -</b> Do not open any panels that require the use of tools.	
	<b>WARNING:</b> Improper installation, adjustment, alteration, service or maintenance can cause property damage, injury or death. Read the Installation, Operating and Maintenance Instructions thoroughly before installing or servicing this equipment.	
	<b>WARNING:</b> Appliance must be connected by an earthing cable to all other units in the complete installation and thence to an independent earth connection.	
	<b>WARNING:</b> Never clean any electrical unit by immersing it in water. Turn off before cleaning surface.	
	<b>WARNING: SHOCK HAZARD -</b> De-energize all power to equipment before cleaning the equipment.	

## CONTENTS

Safety Precautions .....	2
Electrical Specifications.....	4
Features & Operating Controls .....	4
Precautions & General Information .....	5
Agency Listing Information .....	5
Installation .....	6
Operation .....	11
Cleaning Instructions .....	12
Troubleshooting Suggestions .....	13
Maintenance Instructions .....	14
Parts Lists & Exploded Views.....	16
Wiring Diagram.....	20
Warranty.....	23

### LOCATION OF DATA PLATE:

The data plate for the Hot & Cold Pans is located on the right side of the control box.

### IMMEDIATELY INSPECT FOR SHIPPING DAMAGE

All containers should be examined for damage before and during unloading. The freight carrier has assumed responsibility for its safe transit and delivery. If equipment is received damaged, either apparent or concealed, a claim must be made with the delivering carrier.

A) Apparent damage or loss must be noted on the freight bill at the time of delivery. It must then be signed by the carrier representative (Driver). If this is not done, the carrier may refuse the claim. The carrier can supply the necessary forms.

B) Concealed damage or loss if not apparent until after equipment is uncrated, a request for inspection must be made to the carrier within 15 days. The carrier should arrange an inspection. Be certain to hold all contents and packaging material.

Installation and start-up should be performed by a qualified installer who thoroughly read, understands and follows these instructions.

# ELECTRICAL SPECIFICATIONS

MODEL	WARMER			REFRIGERATION			POWER SUPPLY REQUIREMENT	
	VOLTS	KW	1 $\phi$ AMPS	HP	VOLTS	1 $\phi$ AMPS		REFRIGERANT
CHDT-2	240/208 60Hz	2.5/1.9	10.4/9.0	1/4	120 60Hz	5.5	R-134a	3-wire: L1, L2, N #10 AWG min. 60°C
CHDT-3	240/208 60Hz	4.0/3.0	16.7/14.4	1/3	120 60Hz	7.0	R-404a	3-wire: L1, L2, N #10 AWG min. 60°C
CHDT-4	240/208 60Hz	5.0/3.8	20.8/18.1	1/2	120 60Hz	7.5	R-404a	3-wire: L1, L2, N #10 AWG min. 60°C
CHDT-5	240/208 60Hz	8.0/6/0	33.3/28.9	3/4	120 60Hz	15.3	R-404a	3-wire: L1, L2, N #8 AWG min. 60°C
CHDT-6	240/208 60Hz	8.0/6.0	33.3/28.9	3/4	120 60Hz	15.3	R-404a	3-wire: L1, L2, N #8 AWG min. 60°C

**NOTE:** For equipment and cut-out dimensions, refer to the *Installation Instructions* (pages 9 and 10).

## FEATURES & OPERATING CONTROLS

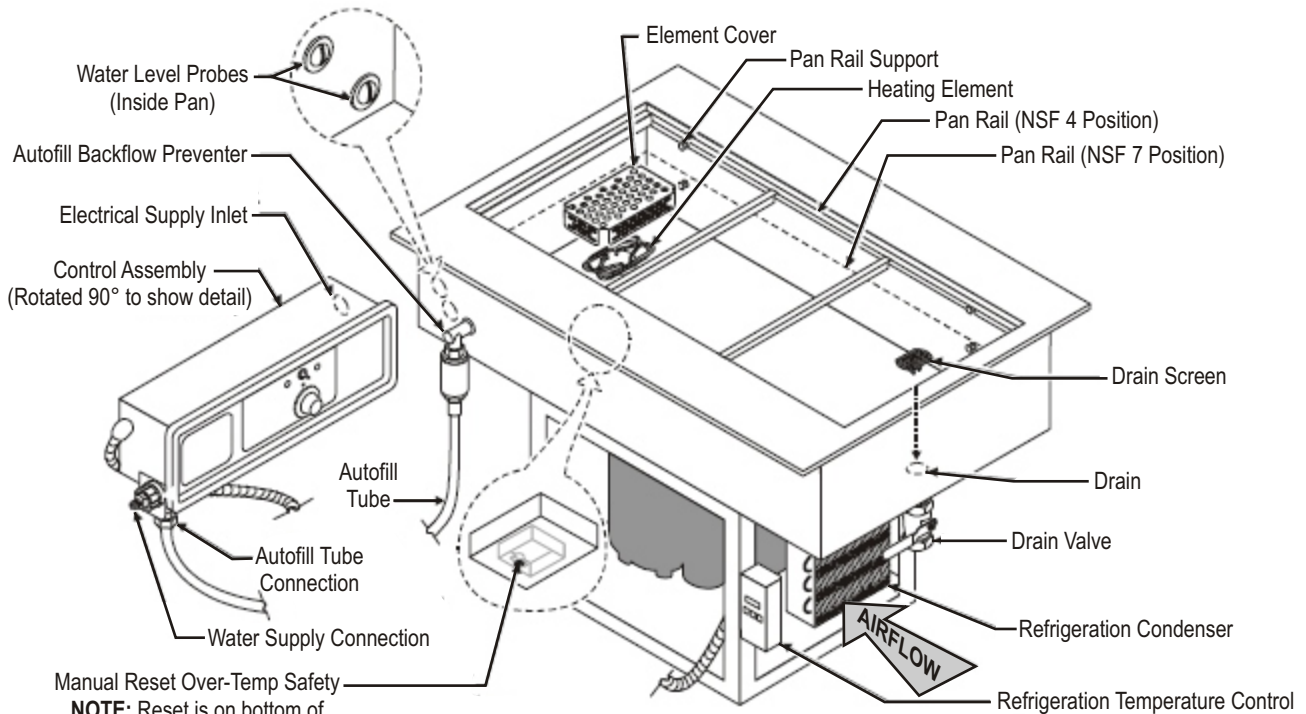

**NOTE:** Reset is on bottom of element and is accessible from outside bottom of tank.

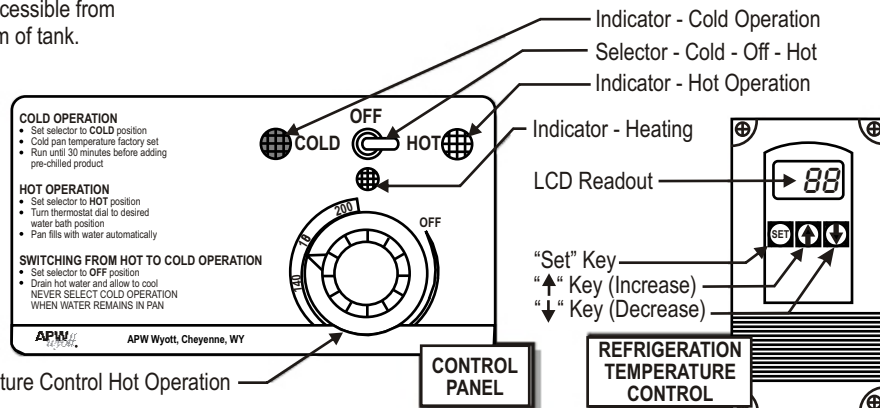

**NOTE:** Model CHDT-3 shown. Others are similar.

## PRECAUTIONS AND GENERAL INFORMATION



**WARNING: ELECTRIC SHOCK HAZARD.** All servicing requiring access to non-insulated electrical components must be performed by a factory authorized technician. DO NOT open any access panel which requires the use of tools. Failure to follow this warning can result in severe electrical shock.



**CAUTION: RISK OF DAMAGE. DO NOT** connect or energize this appliance until all installation instructions are read and followed. Damage to the appliance will result if these instructions are not followed.



**CAUTION: HOT SURFACE.** Exposed surfaces can be hot to the touch and may cause burns.



This appliance is intended for use in commercial establishments only, and is intended to hold previously prepared food for human consumption. Food may be held either hot or cold. No other use is recommended or authorized by the manufacturer or its agents.

Operators of this appliance must be familiar with the appliance use, limitations and associated restrictions. Operating instructions must be read and understood by all persons using or installing this appliance.

For hot operation, the appropriate water level must be maintained at all times. Food must be kept in appropriate inserts. Never place food directly into the tank.

Cleanliness of this appliance is essential to good sanitation. Read and follow all included cleaning instructions and schedules to ensure the safety of the food product.

Disconnect this appliance from electrical power before performing any maintenance or servicing.

DO NOT submerge this appliance in water. This appliance is not jet stream approved. Do not direct water jet or steam jet at this appliance, or at any control panel or wiring. Do not splash or pour water on, in or over any controls, control panel or wiring. Do not wash floor around this appliance with water or steam jet.

Exposed surfaces of this appliance during hot operation can be hot to the touch and may cause burns.

Do not operate this appliance if the control panel is damaged. Call your Authorized Wells Service Agent for service.

The technical content of this manual, including any wiring diagrams, schematics, parts breakdown illustrations and/or adjustment procedures, is intended for use by qualified technical personnel.

Any procedure which requires the use of tools must be performed by a qualified technician.

This manual is considered to be a permanent part of the appliance. This manual and all supplied instructions, diagrams, schematics, parts breakdown illustrations, notices and labels must remain with the appliance if it is sold or moved to another location.

This appliance is made in the USA. Unless otherwise noted, this appliance has American sizes on all hardware.

## AGENCY LISTING INFORMATION

This appliance is performance tested to NSF Standard 4 for holding hot foods. This appliance conforms to NSF Standard 4 for sanitation only if installed in accordance with the supplied Installation Instructions and maintained according to the instructions in this manual.



This appliance performance tested to NSF Standard 7 for storage of potentially hazardous foods. This appliance meets NSF Standard 7 only when pan rails are installed in the lowest position.



Components used in the manufacture of this unit are Underwriters Laboratory recognized.



# INSTALLATION



**CAUTION:** This device should never be positioned upside down or on its side. If the unit arrived or was stored in any position other than “THIS END UP” as marked on the shipping container, then allow the unit to set upright 24 hours before applying power or turning on the unit. Failure to do this will cause the unit to function incorrectly. The unit will not be able to cool to the desired temperature.



**NOTE: DO NOT** discard the carton or other packing materials until you have inspected the appliance for hidden damage and tested it for proper operation. Refer to SHIPPING DAMAGE CLAIM PROCEDURE on page 3 of this manual.



**WARNING: RISK OF INJURY.** Installation procedures must be performed by a qualified technician with full knowledge of all applicable electrical and plumbing codes. Failure can result in personal injury and property damage.



**IMPORTANT:** Unit must remain in an upright position during installation to prevent damage to the refrigeration system.



**IMPORTANT:** Refrigeration system is air cooled. Recommend louvered grills or equivalent openings on left and right side of condensing unit, with a minimum size of twice the condenser area (each opening) in order to provide adequate air circulation.



**IMPORTANT: DO NOT** block air openings. Damage to the compressor will result. Damage caused by improper air circulation is NOT covered by warranty.



**IMPORTANT:** Access is required for the operation of the drain valve and for maintenance of the refrigeration unit. Provide adequate access to the drain valve and refrigeration unit.



## UNPACKING & INSPECTION

Carefully remove the appliance from the carton. Remove all protective plastic film, packing materials and accessories from the appliance before connecting electrical power or otherwise performing any installation procedure.

Carefully read all instructions in this manual and the Installation Instruction Sheet packed with the appliance before starting any installation.

Read and understand all labels and diagrams attached to the appliance.

Carefully account for all components and accessories before discarding packing materials. Store all accessories in a convenient place for later use.

## COMPONENTS

(2 Ea.)	Pan Rail, Side	(2 Ea.)	Pan Rails, End
(1 - 5 Ea.)	Pan Rails, Intermediate ( Qty Differs With Unit)	(1 Ea.)	Drain Screen
(1 Ea.)	Backflow Preventer Assembly	(1 Ea.)	Drain Valve

## PREPARATION

Cutout dimensions for tank units and control panels are listed on the Installation Instructions provided with the unit.

Countertop must be flat and level before the unit is installed. After cutout is made, add stiffeners or bottom braces to counter as required to support unit weight.

Provide louvered grills and service access below control panel.

Verify that provided sealants are applied to the underside of the top flange prior to setting the unit into the cutout.

After installation, apply a thin bead of food-grade silicone sealant around the flange to seal it to the counter.



**IMPORTANT:** Unit flange must be sealed to the counter top. Damage caused by leaks due to improper installation is NOT covered by warranty.



For installation in plastic (e.g. Corian®) counter tops, the counter material must be protected from the heat of the warmer in order to prevent discoloration and/or deterioration. The installer should contact the manufacturer or distributor of the countertop material for specific installation instructions.



Avoid storing flammable or combustible materials in, on or near the appliance.



**WARNING: ELECTRIC SHOCK HAZARD.** All servicing requiring access to non insulated electrical components must be performed by a factory authorized technician. **DO NOT** open any access panel which requires the use of tools. Failure to follow this warning can result in severe electrical shock.



**CAUTION: RISK OF DAMAGE. DO NOT** connect or energize this appliance until all installation instructions are read and followed. Damage to the appliance will result if these instructions are not followed.



**CAUTION: ELECTRICAL SHOCK HAZARD.** The ground lug of this appliance must be connected to a suitable building ground.



**IMPORTANT:** Contact a licensed electrician to install and connect electrical power to the appliance.



**IMPORTANT:** Damage due to being connected to the wrong voltage or phase is **NOT** covered by warranty.



## ELECTRICAL INSTALLATION

1. Refer to the nameplate. Verify the electrical service power. Voltage and phase must match the nameplate specifications. Wiring the unit to the wrong voltage can severely damage the unit or cause noticeably decreased performance.
2. Available electrical service amperage must meet or exceed the specifications listed on the specification sheet provided with the unit. Connect to the terminal block in the control unit. Wiring must be secured to the control unit with an appropriate strain relief (provided by installer).

### **IMPORTANT:**

- \* L1 to L2 must be 208 to 240 volts AC.
- \* L2 to Neutral must be 120 volts AC

3. Tank and control unit must be connected to an appropriate building ground. Ground connection will be marked "GND" or "⏏".

**NOTE:** Wire gauge, insulation type and temperature rating, as well as type, size and construction of conduit, must meet or exceed applicable specifications of local codes and of the National Electrical Code.

## PLUMBING INSTALLATION

**IMPORTANT:** All plumbing installations must be performed by a qualified plumber.

**NOTE:** Plumb connections must be made in compliance with all Federal, State and Local Plumbing Codes and Ordinances.

**NOTE:** All water line connections are made **OUTSIDE** of the control unit.

1. Install provided 1" drain valve on unit drain. Plumb to an appropriate waste as required by local plumbing and sanitation ordinances.

2. Install provided backflow preventer assembly to the tank water inlet. Attach water outlet tubing from water connection (located on bottom left of control unit) to the inlet of the backflow preventer.  
**NOTE:** While a backflow preventer is incorporated into the unit, local codes may require an additional backflow preventer or vacuum breaker in the water inlet line.
3. The unit must be connected to a potable cold water supply line with average pressure between 20 PSI and 90 PSI. If your water pressure exceeds 90 PSI at anytime, a pressure regulator must be installed in the water supply line to limit the pressure to not more than 90 PSI in order to avoid damage to lines and solenoid. Install water supply to inlet fitting (located on left side of control unit) with a 1/4" female flare.
4. A water shut-off valve should be installed on the incoming water line in a convenient location (Use a low restriction type valve, such as a 1/4-turn ball valve, to avoid loss of water flow thru the valve).
5. Test the operation of the autofill in the HOT operation mode.



# INSTALLATION INSTRUCTIONS SELF CONTAINED DROP-IN HOT & COLD PAN

Models: CHDT-2 Thru CHDT-6 (Continued on following page)



Meets NSF Standard 7  
Performance requirements  
At 3" Pan Rail Depth

MINIMUM CLEARANCE REQUIRED FROM UNIT TO THE NEAREST SURFACE			
BACK	SIDE	BOTTOM	FRONT
0 (0)	0 (0)	N/A	3 (76)
INCHES (MM)			

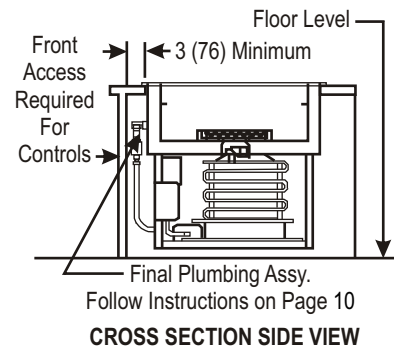
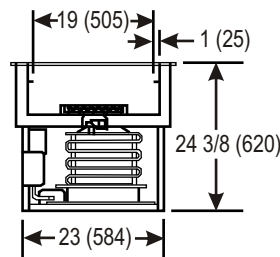
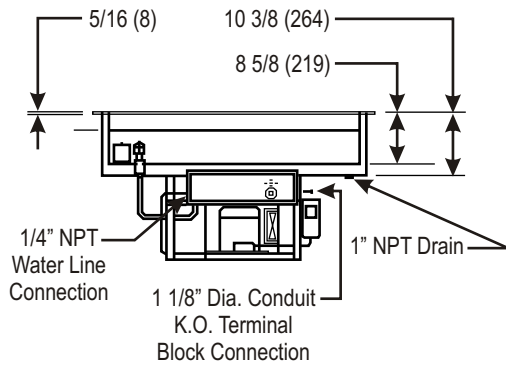
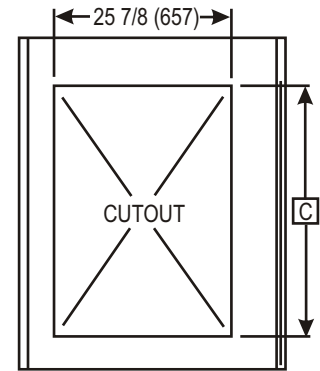
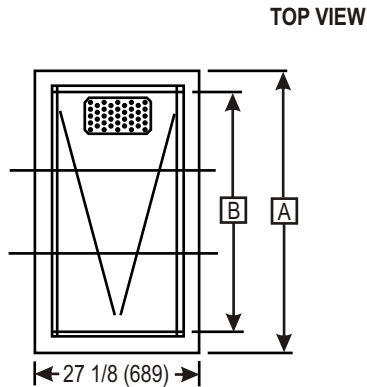

**DIMENSIONS (INCHES/MM)**

Model	A		B		C (Cutout)	
	Inches	MM	Inches	MM	Inches	MM
<b>CHDT-2</b>	33 3/4	832	25 1/2	648	31 1/2	800
<b>CHDT-3</b>	48 1/2	1181	39 1/4	997	45 1/4	1149
<b>CHDT-4</b>	60 1/4	1530	53	1346	59	1499
<b>CHDT-5</b>	74	1880	66 3/4	1695	72 3/4	1848
<b>CHDT-6</b>	87 3/4	2229	80 1/2	2045	86 1/2	2197

**ELECTRICAL RATING**

Model	WARMER				REFRIGERATION				Single Phase Supply 3-Wire 120/208-240V L1-L2 208-240V L@-N 120VAC 60Hz	
	Volts	KW	Amps 1-Ph		Volts	HP	Amps 1-Ph			Refrigerant Type
			L1-L2	N			L2-N	L1		
<b>CHDT-2</b>	208	1.9	9.0	N/A	120	1/4	5.5	N/A	<b>ALL MODELS PERMANENTLY CONNECTED</b>	
	240	2.5	10.4	N/A						
<b>CHDT-3</b>	208	3.0	14.4	N/A	120	1/3	7.0	N/A		
	240	4.0	16.7	N/A						
<b>CHDT-4</b>	208	3.8	18.1	N/A	120	1/2	7.5	N/A		
	240	5.0	20.8	N/A						
<b>CHDT-5</b>	208	6.0	28.9	N/A	120	3/4	15.3	N/A		
	240	8.0	33.3	N/A						
<b>CHDT-6</b>	208	6.0	28.9	N/A	120	3/4	15.3	N/A		
	240	8.0	33.3	N/A						

# INSTALLATION INSTRUCTIONS SELF CONTAINED DROP-IN HOT & COLD PAN

Models: CHDT-2 Thru CHDT-6 (Continued from previous page)

## INSTALLATION INSTRUCTIONS

INSTALLER MUST MEET CONDITIONS OF ACCEPTABILITY OUTLINED BELOW UPON INSTALLATION:

1. This unit may be installed in stainless steel, wood, Formica or Corian tables and countertops.
2. This unit requires drain connection. It also requires a 120/208-240 volt, single phase power supply connection.
3. When installing unit, it is essential to provide front access for service & temperature adjustment. It should have air openings to allow for proper air circulation. Opening shall be at least twice the surface area of the condenser. Improper ventilation causes compressor burnout & voids the warranty.

TO FABRICATE:

1. Lay out "cutout" dimensions on countertop or table.
2. Cut out hole. Make certain countertop is flat and level side to side and front to back before installing the unit.
3. Provide support from below to reduce load on countertop. For remote control panel mounting see below.

TO INSTALL:

1. Apply a generous bead of silicone sealant to underside of mounting flange before setting unit into cutout. Remove excess sealant from top flange and countertop.
2. Remove thermostat knob and recessed control panel from control box for access to terminal block. FOR PLUMBING AND WIRING (SEE BELOW)

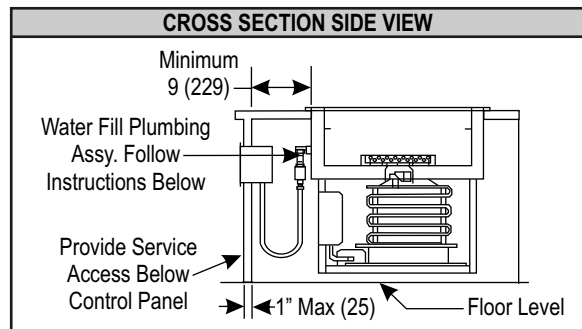
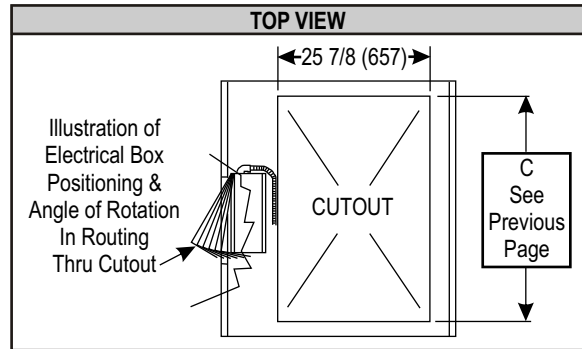
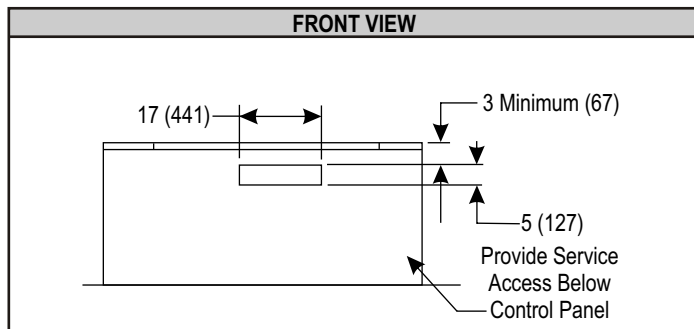
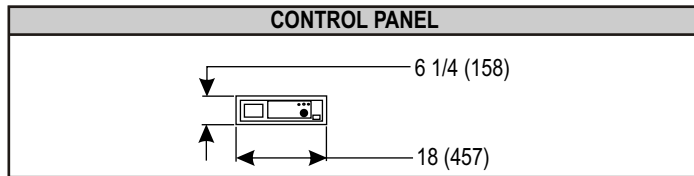

## REMOTE CONTROL PANEL INSTALLATION INSTRUCTIONS

TO FABRICATE:

1. Lay out "cutout" dimensions on countertop or table.
2. Lay out control panel cutout in the front apron. **NOTE:** Control panel assembly is provided with extra length of flexible conduit and electric wiring. This option allows for installation of the controls outside the enclosure for easy access. Provide louvered grills service access and temperature adjustment to the refrigeration system.

TO INSTALL:

1. Apply a generous bead of silicone sealant to underside of mounting flange before setting unit into cutout.
2. Lower the unit into the counter cutout. Wipe clean excess sealant.
3. Remove thermostat knob and recessed control panel from control box.
4. Remove control box assembly from framework. Release wiring conduit from wire ties and retainers.
5. Install control box (refer to "Top View") by routing it thru the cutout.
6. Fasten control box by using six (6) screws provided.

## PLUMBING AND WIRING INSTRUCTIONS

TO PLUMB:

**NOTE:** Plumbing connections must be completed after the unit is lowered onto the counter cutout. The water fill hose with check valve assembly is shipped disconnected from the tank for ease of setting unit into the cutout at installation.

1. Apply pipe sealant to the water fill tank fitting and attach the pre-assembled check valve assembly.
2. Attach water fill hose fitting with hose clamp.
3. Connect 1/4 NPT water supply and shut off valve to solenoid valve in control box. **NOTE:** Maximum pressure 120 psi. Maximum Temperature 120°F.
4. A drain valve is supplied with the unit. It is the discretion of the installer to locate the position of the handle. Connect 1" drain to drain pan or floor drain. Valve access must be provided for draining pan.

TO WIRE:

**NOTE:** MAKE CERTAIN POWER LINE IS DE-ENERGIZED BEFORE WIRING APPLIANCE.

Unit operates on 120/208-240 volt single phase system. Use #8 AWG minimum 60° C supply leads only. Make certain that "L1 to L2" reads 208 to 240 VAC and "L2 to N" reads 120 VAC. Bring supply leads through 1 1/8" conduit K.O. to terminal block pre-installed in the electrical box. Install control panel & control knob.

**NOTE:** INSTALLATION MUST MEET LOCAL PLUMBING AND ELECTRICAL CODES.

A backflow preventer check valve is incorporated in unit between water fill solenoid and pan. Local codes may require additional vacuum break device.

# OPERATION



**CAUTION: HOT SURFACE.** Exposed surfaces can be hot to the touch and may cause burns.



**CAUTION: ELECTRICAL SHOCK HAZARD. DO NOT** splash or pour water onto control panel or wiring.



**CAUTION: EQUIPMENT DAMAGE. DO NOT** operate the unit without the element cover in place. Operation without the element cover will allow damage to the temperature sensing element.



**NOTE:** CHDT units are performance tested to NSF Standard 4 for holding hot foods. Always drain unit and allow to cool before switching to COLD operation.



## HOT OPERATION

1. Verify that drain valve is CLOSED, the DRAIN SCREEN is in place, and the ELEMENT COVER is properly positioned over the heating element.
2. Turn SELECTOR SWITCH to HOT. The red HOT indicator will glow and the tank will begin filling with water.
3. Set the TEMPERATURE CONTROL to the desired temperature. When the water in the tank reaches the minimum water level the heating elements are energized and the water will begin heating. The HEAT indicator will glow while the unit is heating.
  - a. Temperature range is (OFF) - 85°F to 205°F.
  - b. When the HEAT indicator goes out, the water in the tank is up to the set temperature.
4. Install the pan rails.
  - a. Side rails are installed first. For normal hot operation, install the side rails on the upper pan rail supports.
  - b. Install the end rails, then any intermediate rails.
5. Install pans or insets on the pan rails.

**IMPORTANT:** Always use a pan or inset.  
Never place food directly into the tank.
6. Cover pans and insets to maintain consistent temperature. Stir thick foods frequently.

## SHUT DOWN PROCEDURE

1. Turn SELECTOR SWITCH to OFF. The red HOT indicator will turn off.
2. Remove all pans and insets.
3. Open drain valve.

**COLD OPERATION**

- Set selector to COLD position
- Cold pan temperature factory set
- Run until 30 minutes before adding pre-chilled product

**HOT OPERATION**

- Set selector to HOT position
- Turn thermostat dial to desired water bath position
- Pan fills with water automatically

**SWITCHING FROM HOT TO COLD OPERATION**

- Set selector to OFF position
- Drain hot water and allow to cool
- NEVER SELECT COLD OPERATION WHEN WATER REMAINS IN PAN

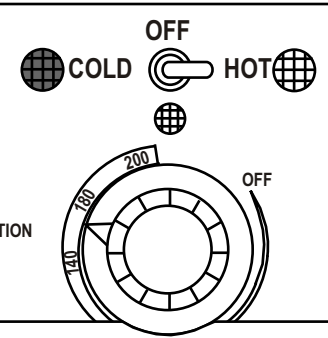

**APW** WYOTT APW Wyott, Cheyenne, WY



**CAUTION: ELECTRICAL SHOCK HAZARD. DO NOT** splash or pour water onto control panel or wiring.



**NOTE:** CHDT units are performance tested to NSF Standard 4 for holding non-critical foods.



**NOTE:** CHDT units are performance tested to NSF Standard 7 for holding potentially hazardous foods only when the pan rails are installed on the lower pan rail supports. Ambient room temperature must be 86°F (30°C) or less. Unit maintains pre-chilled foods at 33°F - 41°F.



**NOTE:** Tank must be dry for COLD operation. Water in the tank will form ice, compromising the cooling to the food product. Ice in the tank will delay the proper use of the unit when switching to HOT operation.



## COLD OPERATION

1. Verify that drain valve is OPEN, and the ELEMENT COVER is properly positioned over the heating element. The tank must be dry.
2. Turn SELECTOR SWITCH to COLD. The white COLD indicator will glow. When the tank cools to 100°F or less, the refrigeration system will start.
3. The temperature is factory set to NSF 7 required of 33°F - 41°F.
4. Install the pan rails.
  - a. Side rails are installed first. For normal cold operation, install the side rails on the upper pan rail supports. For holding potentially hazardous foods, install the side rails on the lower pan rail supports.
  - b. Install the end rails, then any intermediate rails.
5. Install pans or insets on the pan rails.

**IMPORTANT:** Always use a pan or inset.

Never place food directly into the tank.

**IMPORTANT:** For NSF 7 operation, use 12" x 20" x 4" deep pans, and use the lower pan rail supports which are recessed 3" from tank top.

## SHUT DOWN PROCEDURE

1. Turn SELECTOR SWITCH to OFF.  
The white COLD indicator will turn off.
2. Remove all pans and insets.

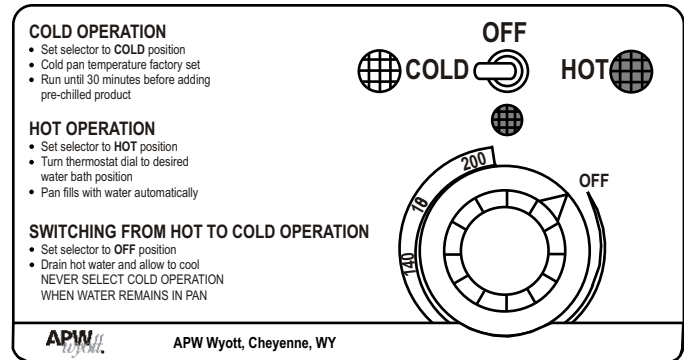

## CLEANING INSTRUCTIONS

- CAUTION: ELECTRICAL SHOCK HAZARD. DO NOT** splash or pour water onto control panel or wiring.
- CAUTION: EQUIPMENT DAMAGE. DO NOT** operate the unit without the element cover in place. Operation without the element cover will allow damage to the temperature sensing element.
- IMPORTANT: DO NOT** use steel wool for cleaning.

**PREPARATIONS:** Turn temperature control knob and selector switch to OFF. Allow tank to cool before proceeding. Remove any insets, pans and/or adapter tops ( if used). Drain water from tank.

**FREQUENCY:** Daily

**TOOLS:** Warm Water and Mild Detergent Solution: 10 Parts Warm Water to 4 Parts Vinegar, Plastic scouring Pad, Clean Cloth or Sponge, Food-Grade Silicone Sealant.

1. Remove pan rails, element cover and drain screen. Wipe interior of tank using a clean cloth or sponge and mild detergent.
2. Use a plastic scouring pad to remove any mineral deposits from water level probes.
3. Rinse tank thoroughly with a vinegar and water solution to neutralize all detergent/cleanser residue.
4. Pan rails and element cover may be washed in a sink or dishwasher. Allow to dry thoroughly, then reinstall.
5. Check drain screen, clean if necessary and reinstall.
6. Periodically inspect warmer flange-to-counter seal. Reseal with food-grade silicone sealant if necessary.
7. Inspect tank and control panel for damage. Contact your Authorized APW Wyatt Service Agency for repairs if water or grease contamination is suspected.
8. Inspect cooling louvers in counter. Remove any lint or debris. *(Procedure is complete)*

## TROUBLESHOOTING SUGGESTIONS

SYMPTOM	POSSIBLE CAUSE	REMEDY
No power to unit	Circuit breaker tripped	Reset circuit breaker
	Selector switch OFF	Set to HOT or COLD
Unit won't heat	Selector switch not set to HOT	Set to HOT
	Insufficient water in tank	Be sure drain valve is closed. Allow to fill above min water level
	Temp control not set high enough	Set temp control
	Min water level sensor dirty	Clean water level sensors
	Hi-limit safety tripped	Allow to cool, reset hi-limit
	Internal damage	Contact Authorized APW Service Agent for repairs
Unit won't cool	Selector switch not set to COLD	Set to COLD
	Tank too hot	Allow to cool to 100°F or less
	Condenser cooling louvers or coil plugged	Clean condenser louvers and/or coil
	Internal damage	Contact Authorized APW Service Agent for repairs
Tank won't fill	Selector switch not set to HOT	Set to HOT
	Max water level sensor dirty	Clean water level sensors
	Drain valve open	Be sure drain valve is closed
	Internal damage	Contact Authorized APW Service Agent for repairs
Tank overflows	Max water level sensor dirty	Clean water level sensors
	Internal damage	Contact Authorized APW Service Agent for repairs
Food not kept cold enough	Food not chilled to start	Add only pre-chilled food
	Pan rails set too high	For NSF 7 operation use lower pan rail supports
	Condenser cooling louvers or coil plugged	Clean condenser louvers and/or coil
	Refrigerant adjustment needed	Contact Authorized APW Service Agent for repairs
Food not kept hot enough	Food not warm to start	Add only pre-heated food
	Food too thick	Stir thick food frequently
	Temp control not set high enough	Set temp control to desired temp
	One hi-limit tripped (CHDT-4 -5, -6)	Allow to cool, reset hi-limit
	Internal damage	Contact Authorized APW Service Agent for repairs

# MAINTENANCE INSTRUCTIONS



**CAUTION: INJURY HAZARD.** Disconnect appliance from electrical power before cleaning.



**NOTE:** APW Wyott hot and cold pans are constructed of high quality stainless steel. As long as the stainless steel surface is intact, the equipment will not rust or corrode.



**RECOMMENDATION:** A water softening device or a cartridge-type filtration device may be used to minimize lime and calcium build-up.



## CARE OF STAINLESS STEEL

1. The surface can be damaged by mechanical abrasion, hard water deposits and chlorine:
  - a. **NEVER** use steel wool, wire brushes or metal scrapers to clean the appliance. These will damage the surface.
  - b. Hard water deposits left behind when water is evaporated will attack the surface and allow the stainless steel to rust.
  - c. Chlorides from chlorinated cleansers, calcium / lime / rust removers (e.g. muriatic acid), even heavily chlorinated city water will attack the surface and allow the stainless steel to rust.
  - d. **DO NOT** use any highly caustic cleaners. Use of highly caustic cleaners will damage the surface.
  - e. **LIMIT USE** of strong caustic cleaners on warmers. Rinse thoroughly with a vinegar and water solution to neutralize any residue. Failure to do so may cause damage to the surface and allow the stainless steel to rust.
  - f. Cleansers containing ammonia will attack the surface and allow the stainless steel to rust.
2. Use the proper tools in the proper way to clean your Wells warmer:
  - a. Soft cloth and plastic scouring pads are safe to use on stainless steel surfaces.
  - b. Stainless steel pads may be used **ONLY IF** the scrubbing motion is in the direction of the visible grain. **DO NOT** use a circular motion.
  - c. In the absence of visible grain, use only soft cloth or plastic pads. Scrub only in a linear motion along the longest axis of the equipment.
3. Use only non-chloride and non-ammonia cleansers:
  - a. **DO NOT** use any cleanser listed as "chlorinated".
  - b. **DO NOT** use any cleanser listing "ammonia" or "ammonium" in its contents.
  - c. Contact your cleaning materials supplier for suitable alkaline cleansers.
4. Keep your APW Wyott hot and cold pan clean. Clean frequently to avoid build-up of hard, stubborn stains and hard-to-remove deposits:
  - a. Rinse thoroughly with a vinegar and water solution to neutralize any residue.
  - b. For discoloration caused by using the warmer in dry operation, use a cleaner made specifically for stainless steel.
  - c. Wipe dry with a soft, clean, dry cloth.
  - d. Restore the surface by using a polishing product specifically made for stainless steel after each cleaning.
5. In areas where tap water has a high mineral content, warmers may develop lime deposits. Use a non-chloride de-liming agent to remove lime deposits. It is important to use Lime and Scale Cleaner for Warmer Pans often to prevent a difficult-to-remove build-up of lime deposits.



**FIRST AID: EYES:** In case of contact, immediately flush with warm water for 15 minutes and consult a physician

**SKIN:** Wash with soap and water

**INHALATION:** Relocate to fresh air.

**INGESTION:** If swallowed, drink plenty of water or milk and consult a physician

**EMERGENCY PHONE :** (800) 255-3924





**IMPORTANT:** Turn selector switch OFF if soaking overnight.



## LIME AND SCALE CLEANER INSTRUCTIONS

APW Wyott Lime and Scale Cleaner for Warmer Pans (instructions modified for use in Hot and Cold Pan)

NOTE: Perform weekly, or whenever lime or scale is seen accumulating on the sides of the tank.

1. Add water to tank until water is at normal operating level or until water covers accumulated scale.
2. Turn SELECTOR SWITCH to HOT. Heat water to maximum temperature (190°F or higher).
3. For CHDT-2, use two packages, -3 use 3 packages, -4 use 4 packages, -5 use 5 packages, -6 use 6 packages:  
Pour contents packages into tank. Stir to dissolve cleaner. Cover tank.
4. Allow solution to soak at least one hour, or overnight for heavy scale buildup.
5. After soak period, turn control to OFF position.
6. Drain hot water from pans. Scrub with a plastic scouring pad. Rinse thoroughly with hot water then dry.
7. Refill tank and resume operation.
8. Heavy scale buildup may require additional treatments.

## CONDENSER COIL CLEANING INSTRUCTIONS

The condenser coil must be kept clean to allow adequate air flow for proper heat dissipation. Recommend this procedure be performed monthly.

1. Turn selector switch to OFF. Disconnect appliance from electrical power.
2. Remove louvers or access panel to allow coil to be reached.
3. Using a stiff bristle brush, brush lint and debris from the condenser fins. Brush vertically, top to bottom. Collect and discard all lint and debris gathered from this operation  
**IMPORTANT:** The fins of the condenser coil are delicate and easily damaged. Use care to brush only in a vertical motion to avoid damaging the coil fins.
4. Wipe the fan blades to remove accumulated lint.
5. Reconnect to electrical power. Refer to COLD Operation (page 9) and test for proper operation.



**CAUTION: HOT SURFACE.** Exposed surfaces can be hot to the touch and may cause burns.



**CAUTION: INJURY HAZARD.** Disconnect appliance from electrical power before cleaning condenser coil.



**CAUTION: INJURY HAZARD.** Condenser coil fins are sharp. Use care to avoid cuts while cleaning the condenser.





# PARTS LISTS w/EXPLODED VIEWS

## Exploded View - CHDT

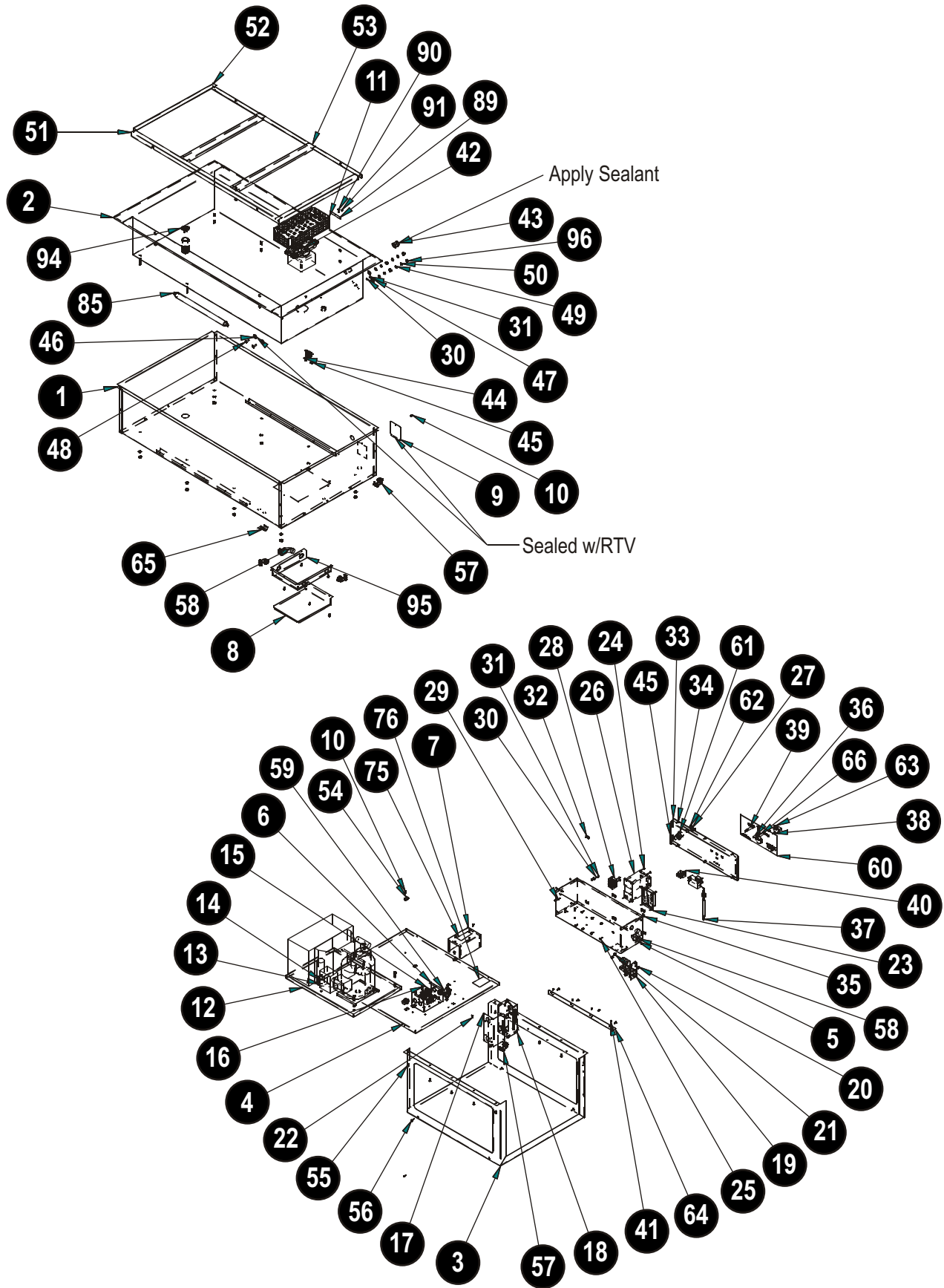

# Additional Exploded Views - CHDT

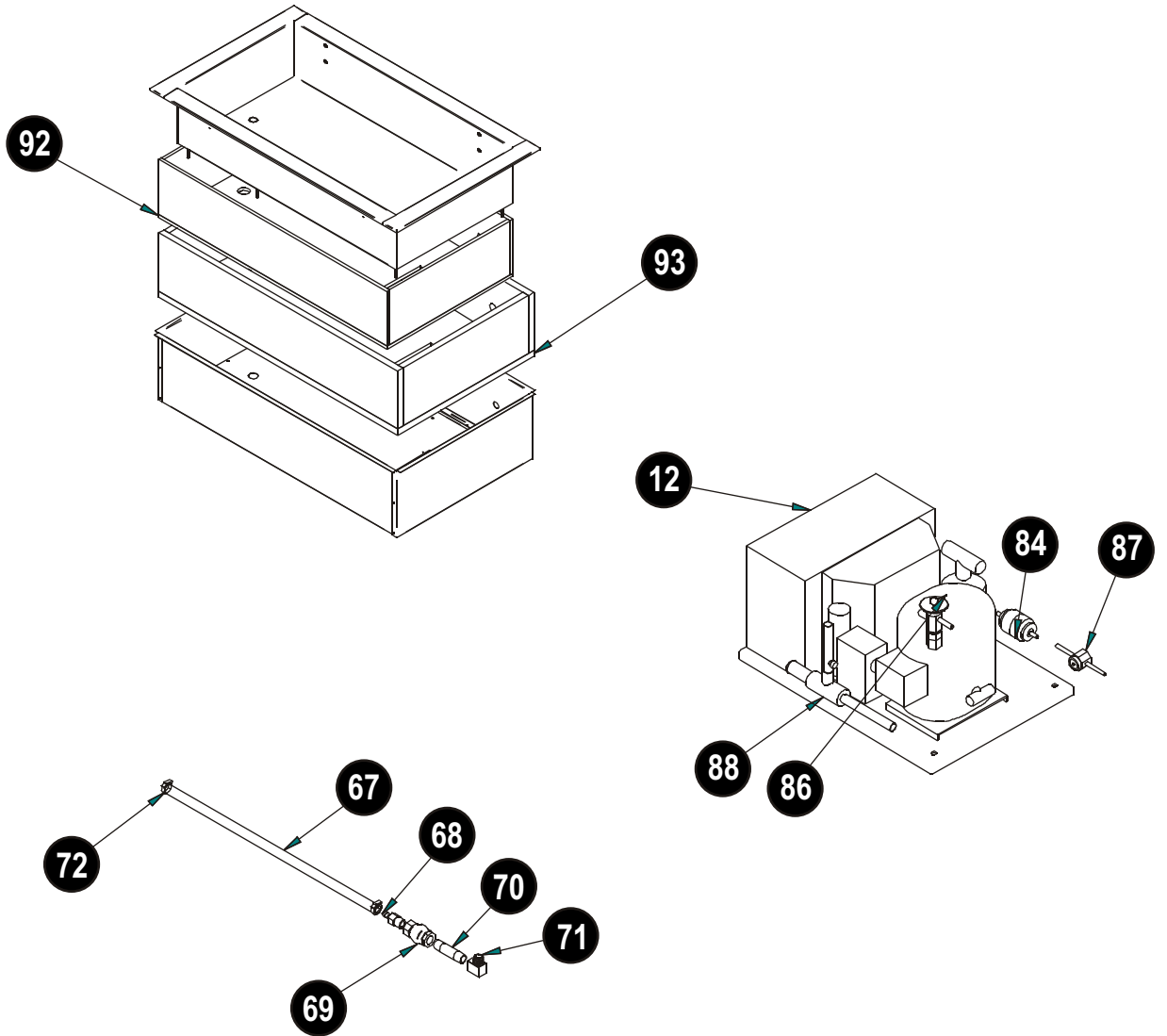

Note: Apply sealant to all mating pipe threads.

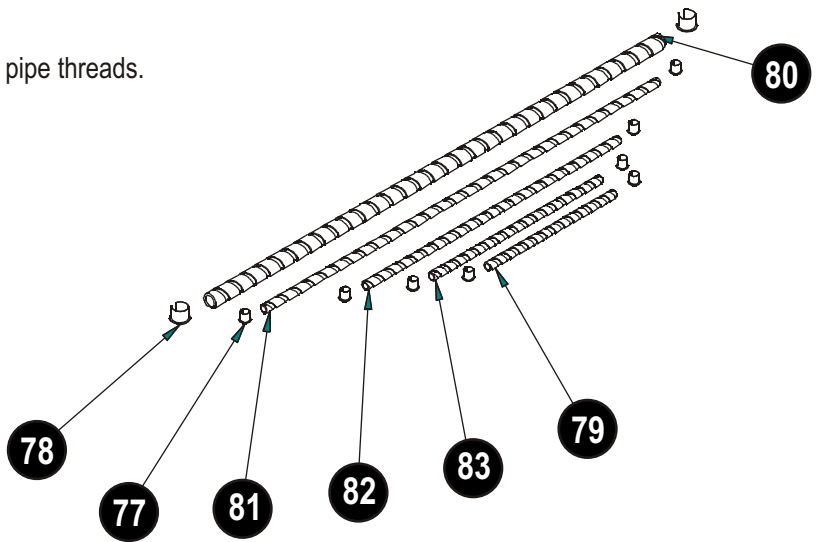

**Parts List - CHDT**

Item	Description	CHDT-2		CHDT-3		CHDT-4		CHDT-5		CHDT-6	
		P/N	Quan	P/N	Quan	P/N	Quan	P/N	Quan	P/N	Quan
1	Assy, Outer Well	30070210	1	30070310	1	30070410	1	30070510	1	30070610	1
2	Weld'mt Inner Well	30070205	1	30070305	1	30070405	1	30070505	1	30070605	1
3	Compressor Housing	30070253	1	30070253	1	30070253	1	30070253	1	30070253	1
4	Compressor Base	30070217	1	30070217	1	30070617	1	30070617	1	30070617	1
5	Control Box	30070218	1	30070218	1	30070218	1	30070218	1	30070218	1
6	J-Box 3.5 x 5.5 x 3.0	30070222	1	30070222	1	30070222	1	30070222	1	30070222	1
7	Cover J-Box	30070223	1	30070223	1	30070223	1	30070223	1	30070223	1
8	Cover, Htr Mount	30070227	1	30070227	1	30070227	1	30070227	1	30070227	1
9	Cover, Sensor	30070234	1	30070234	1	30070234	1	30070234	1	30070234	1
10	#8-32 x 3/8 Type T	8153100	21	8153100	21	8153100	26	8153100	26	8153100	26
11	Cover, Element	30070246	1	30070246	1	30070246	2	30070246	2	30070246	2
12	Condensing Unit Assembly ½ HP	1807210	1	1807211	1	1807212	1	1807213	1	1807213	1
13	Washer, Split Lock, 1/4 SS	8508200	4	8508200	4	8508200	4	8508200	4	8508200	4
14	Screw, Mach., 1/4-20 x 1"	8211400	4	8211400	4	8211400	4	8211400	4	8211400	4
15	Relay, Power 120V 40A	782165	1	782165	1	782165	1	782165	1	782165	1
16	8-32 X 3/4" Ss Pan Hd	8143000	2	8143000	2	8143000	2	8143000	2	8143000	2
17	Bracket, Elec. T-Meter	30070247	1	30070247	1	30070247	1	30070247	1	30070247	1
18	Thermostat, Electronic Control	1475010	1	1475010	1	1475010	1	1475010	1	1475010	1
19	Valve, Solenoid	2069806	1	2069806	1	2069806	1	2069806	1	2069806	1
20	Screw, Machine #10-32 x ½, S/S	8172100	2	8172100	2	8172100	2	8172100	2	8172100	2
21	Nut, Hex, KEPS 10-32	8417100	2	8417100	2	8417100	2	8417100	2	8417100	2
22	Screw, Sm, #10 x 3/8, Type AB	8197100	2	8197100	2	8197100	2	8197100	2	8197100	2
23	Controller, Liquid Level	784671	1	784671	1	784671	1	784671	1	784671	1
24	M/S Tr Hd Ph 6-32 x 3/4"	8110100	10	8110100	10	8110100	10	8110100	10	8110100	10
25	Nut, Hex KEPS, #6-32	8400100	10	8400100	10	8400100	10	8400100	10	8400100	10
26	Contacto	1300310	1	1300310	1	1300310	1	1300310	1	1300310	1
27	Fuse	1503020	1	1503020	1	1503020	1	1503030	1	1503030	1
28	Block, Terminal, 3-pole, Kulka	1127100	1	1127100	1	1127100	1	1127100	1	1127100	1
29	MS Rd Hd Ph 10-24 x 1/2	8158800	1	8158800	1	8158800	1	8158800	1	8158800	1
30	Lockwasher, Ext Tooth # 10	8506000	3	8506000	3	8506000	3	8506000	3	8506000	3
31	#10-24 Hx Nut Grn	8422400	3	8422400	3	8422400	3	8422400	3	8422400	3
32	Nut, U-Type	8196601	6	8196601	6	8196601	6	8196601	6	8196601	6
33	Control Panel	30070219	1	30070219	1	30070219	1	30070219	1	30070219	1
34	#10-24 x 1/2 Tr Hd S/S	8162900	6	8162900	6	8162900	6	8162900	6	8162900	6
35	Grommet, 1/8 ID x 5/8 OD x .190 THK	2126300	1	2126300	1	2126300	1	2126300	1	2126300	1
36	Indicator Light, 250V Red	1513910	1	1513910	1	1513910	1	1513910	1	1513910	1
37	Thermostat, Bulb	1475030	1	1475030	1	1475030	1	1475030	1	1475030	1
38	Screw, Mach, 6-32 x 1/4" Lg.	8103400	2	8103400	2	8103400	2	8103400	2	8103400	2
39	Light Indicator, Red 250V	1512509	1	1512509	1	1512509	1	1512509	1	1512509	1
40	Switch, Toggle DPST	1301910	1	1301910	1	1301910	1	1301910	1	1301910	1
41	Pop Rivet	8353000	11	8353000	11	8353000	11	8353000	11	8353000	11
42	Heater, Immersion	781387	1	781397	1	781387	2	781397	2	781397	2
43	Coupling, Brass	2092634	1	2092634	1	2092634	1	2092634	1	2092634	1
44	Control, Temperature	784665	1	784665	1	784665	1	784665	1	784665	1
45	#8-32 Hex Nut, KEPS, Ni	8408300	4	8408300	4	8408300	4	8408300	4	8408300	4
46	Insulator, Plate	30070241	2	30070241	2	30070241	2	30070241	2	30070241	2
47	Insulator, Washer	30070242	2	30070242	2	30070242	2	30070242	2	30070242	2
48	1/4-20 x .75 Tr Hd	8208200	2	8208200	2	8208200	2	8208200	2	8208200	2

**Parts List - CHDT**

Item	Description	CHDT-2		CHDT-3		CHDT-4		CHDT-5		CHDT-6	
		P/N	Quan	P/N	Quan	P/N	Quan	P/N	Quan	P/N	Quan
49	Washer, Flat 1/4"	8507600	10	8507600	12	8507600	14	8507600	16	8507600	18
50	Washer, Lock, Int, 1/4, Z	8507900	4	8507900	4	8507900	4	8507900	4	8507900	4
51	Angle, Support Long	30070252	2	30070352	2	30070452	2	30070552	2	30070652	2
52	Angle, Support	30070251	2	30070251	2	30070251	2	30070251	2	30070251	2
53	Bar, Adapter	30070248	1	30070248	2	30070248	3	30070248	4	30070248	5
54	Clamp 1/4" Nylon	8980400	3	8980400	3	8980400	3	8980400	3	8980400	3
55	Rivet Pop 3/16 x 3/8	8357600	10	8357600	10	8357600	10	8357600	10	8357600	10
56	8-32 x 1/2 MS	8141400	4	8141400	4	8141400	4	8141400	4	8141400	4
57	Box Connector, 90°	1101500	5	1101500	5	1101500	5	1101500	5	1101500	5
58	Cord Connector	1609200	2	1609200	2	1609200	2	1609200	2	1609200	2
59	Connector, Ins, 3/8" trade, 1/2 KO	1101200	3	1101200	3	1101200	3	1101200	3	1101200	3
60	Decal, Hot Cold Well	8807020	1	8807020	1	8807020	1	8807020	1	8807020	1
61	Fuse Holder	15082-01	1	15082-01	1	15082-01	1	15082-01	1	15082-01	1
62	8-32 x 1/2 MS	8140800	2	8140800	2	8140800	2	8140800	2	8140800	2
63	Knob, Control	781363	1	781363	1	781363	1	781363	1	781363	1
64	Bracket, Cntrl Box	30070254	1	30070254	1	30070254	1	30070254	1	30070254	1
65	Clip Jiffy 1/2"	8969900	3	8969900	3	8969900	3	8969900	3	8969900	3
66	Light Indicator, Wht 250V	1512511	1	1512511	1	1512511	1	1512511	1	1512511	1
67	PVC Tubing	30070266	1	30070266	1	30070266	1	30070266	1	30070266	1
68	Adapter, 3/8"NPT x 3/8" Barbed	2092638	1	2092638	1	2092638	1	2092638	1	2092638	1
69	Valve, Check 3/8"	2065645	1	2065645	1	2065645	1	2065645	1	2065645	1
70	Pipe, 3/8" NPT Brass	2092637	1	2092637	1	2092637	1	2092637	1	2092637	1
71	Elbow, 90°, 3/8"	2092636	1	2092636	1	2092636	1	2092636	1	2092636	1
72	Clamp Snap Grip	8987600	2	8987600	2	8987600	2	8987600	2	8987600	2
73	Label, Spec	8861000	1	8861000	1	8861000	1	8861000	1	8861000	1
74	Label, Service Hotline	8832600	1	8832600	1	8832600	1	8832600	1	8832600	1
75	Label Shock Hazard	8825200	1	8825200	1	8825200	1	8825200	1	8825200	1
76	Label Warning Service Tech	8862650	1	8862650	1	8862650	1	8862650	1	8862650	1
77	Bushing, Anti-Short Size 3	1000700	8	1000700	8	1000700	8	1000700	8	1000700	8
78	Bushing, Anti-Short Size 3	1000200	2	1000200	2	1000200	2	1000200	2	1000200	2
79	Conduit, Flex 3/8" Tr Sz, 9" Long	30070255	1	30070255	1	30070255	1	30070255	1	30070255	1
80	Conduit, Flex 1/2" Tr Sz, 32" Long	30070256	1	30070256	1	30070256	1	30070256	1	30070256	1
81	Conduit, Flex 3/8" Tr Sz, 28" Long	30070257	1	30070257	1	30070257	1	30070257	1	30070257	1
82	Conduit, Flex 3/8" Tr Sz, 18" Long	30070258	1	30070258	1	30070258	1	30070258	1	30070258	1
83	Conduit, Flex 3/8" Tr Sz, 12" Long	30070259	1	30070259	1	30070259	1	30070259	1	30070259	1
84	Dryer 134 A	1812500	1	1812500	1	1812600	1	1812700	1	1812700	1
85	Accumulator	1813500	1	1813500	1	1813500	1	1813500	1	1813500	1
86	Valve, Expansion, EFS-1/8-Z	2069805	1	2069804	1	2069803	1	2069802	1	2069802	1
87	Indicator, Moisture And Liquid	2069810	1	2069810	1	2069810	1	2069811	1	2069811	1
88	Valve, Pres. Reg. Crank Case	2069820	1	2069820	1	2069820	1	2069820	1	2069820	1
89	Clamp, Thermostat Bulb	30070268	2	30070268	2	30070268	4	30070268	4	30070268	4
90	8-32 x .750 Lg. Screw	8142300	2	8142300	2	8142300	4	8142300	4	8142300	4
91	Nut, Hex, 8-32 S/S	8410400	2	8410400	2	8410400	4	8410400	4	8410400	4
92	Kit, Insulation	30070261	1	30070361	1	30070461	1	30070561	1	30070661	1
93	Kit, Insulation Outer	30070262	1	30070362	1	30070462	1	30070562	1	30070662	1
94	Strainer	1217205	1	1217205	1	1217205	1	1217205	1	1217205	1
95	Heater Box	30070224	1	30070224	1	30070224	2	30070224	2	30070224	2
96	Nut, Hex, 1/4-20 SS	8425200	10	8425200	12	8425200	14	8425200	16	8425200	18

# WIRING DIAGRAM

## CHDT Series (2-6) w/Auto Water Fill 120/208-240V, 3 Wire, Single Phase

**ELECTRICAL RATING 120/208-240VAC 60HZ**

Model No.	WARMER			REFRIGERATION				Refrigerant Type
	Volts	KW	Amps 1-Ph L1-L2	Volts	HP	MFS	Amps 1-Ph L2-N	
CHDT -2	208	1.9	9.0	120	1/4	15	5.5	R-134-A
	240	2.5	10.4					
CHDT -3	208	3.0	14.4	120	1/3	15	7.0	R-404-A
	240	4.0	16.7					
CHDT -4	208	3.8	18.1	120	1/2	15	7.5	R-404-A
	240	5.0	20.8					
CHDT -5	208	6.0	28.9	120	3/4	30	15.3	R-404-A
	240	8.0	33.3					
CHDT -6	208	6.0	28.9	120	3/4	30	15.3	R-404-A
	240	8.0	33.3					

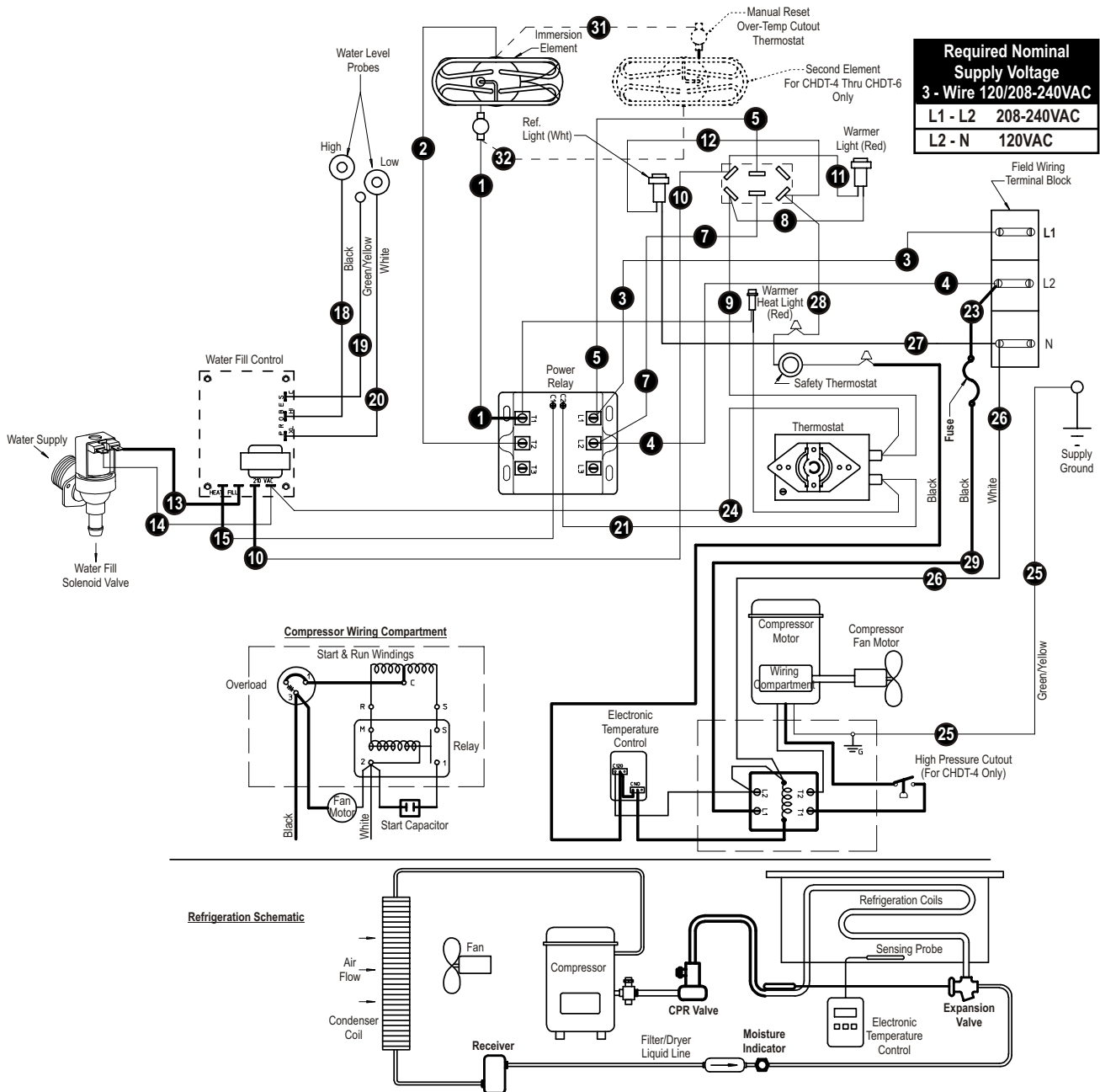







## APW WYOTT EQUIPMENT LIMITED WARRANTY

APW Wyott Foodservice Equipment Company warrants its equipment against defects in materials and workmanship, subject to the following conditions:

This warranty applies to the original owner only and is not assignable.

Should any product fail to function in its intended manner under normal use within the limits defined in this warranty, at the option of APW Wyott such product will be repaired or replaced by APW Wyott or its Authorized Service Agency. APW Wyott will only be responsible for charges incurred or service performed by its Authorized Service Agencies. The use of other than APW Wyott Authorized Service Agencies will void this warranty and APW Wyott will not be responsible for such work or any charges associated with same. The closest APW Wyott Authorized Service Agent must be used.

This warranty covers products shipped into the 48 contiguous United States, Hawaii, metropolitan areas of Alaska and Canada. There will be no labor coverage for equipment located on any island not connected by roadway to the mainland.

Warranty coverage on products used outside the 48 contiguous United States, Hawaii, and metropolitan areas of Alaska and Canada may vary. Contact the international APW Wyott distributor, dealer, or service agency for details.

### Time Period

One year for parts and one year for labor, effective from the date of purchase by the original owner. The Authorized Service Agency may, at their option, require proof of purchase. Parts replaced under this warranty are warranted for the un-expired portion of the original product warranty only.

### Exceptions

**\*Gas/Electric Cookline:** Models GCB, GCRB, GF, GGM, GGT, CHP-H, EF, EG, EHP. Three (3) Year Warranty on all component parts, except switches and thermostats. (2 additional years on parts only. No labor on second or third year.)

**\*Broiler Briquettes, Rock Grates, Cooking Grates, Burner Shields, Fireboxes:** 90 Day Material Only. No Labor.

**\*Heat Strips:** Models FD, FDL, FDD, FDDL. Two (2) Year Warranty on element only. No labor second year.

**\*Glass Windows, Doors, Seals, Rubber Seals, Light Bulbs:** 90 Day Material Only. No Labor.

In all cases, parts covered by extended warranty will be shipped FOB the factory after the first year.

### Portable Carry In Products

Equipment weighing over 70 pounds or permanently installed will be serviced on-site as per the terms of this warranty. Equipment weighing 70 pounds or under, and which is not permanently installed, i.e. with cord and plug, is considered portable and is subject to the following warranty handling limitations. If portable equipment fails to operate in its intended manner on the first day of connection, or use, at APW Wyott's option or its Authorized Service Agency, it will be serviced on site or replaced.

From day two through the conclusion of this warranty period, portable units must be taken to or sent prepaid to the APW Wyott Authorized Service Agency for in-warranty repairs. No mileage or travel charges are allowed on portable units after the first day of use. If the customer wants on-site service, they may receive same by paying the travel and mileage charges. Exceptions to this rule: (1) countertop warmers and cookers, which are covered under the Enhanced Warranty Program, and (2) toasters or rollergrills which have in store service.

### Exclusions

The following conditions are not covered by warranty:

\*Equipment failure relating to improper installation, improper utility connection or supply and problems due to ventilation.

\*Equipment that has not been properly maintained, calibration of controls, adjustments, damage from improper cleaning and water damage to controls.

\*Equipment that has not been used in an appropriate manner, or has been subject to misuse or misapplication, neglect, abuse, accident, alteration, negligence, damage during transit, delivery or installation, fire, flood, riot or act of god.

\*Equipment that has the model number or serial number removed or altered.

If the equipment has been changed, altered, modified or repaired by other than an Authorized Service Agency during or after the warranty period, then the manufacturer shall not be liable for any damages to any person or to any property, which may result from the use of the equipment thereafter.

This warranty does not cover services performed at overtime or premium labor rates. Should service be required at times which normally involve overtime or premium labor rates, the owner shall be charged for the difference between normal service rates and such premium rates. APW Wyott does not assume any liability for extended delays in replacing or repairing any items beyond its control.

In all cases, the use of other than APW Wyott Authorized OEM Replacement Parts will void this warranty.

This equipment is intended for commercial use only. Warranty is void if equipment is installed in other than commercial application.

### Water Quality Requirements

Water supply intended for a unit that has in excess of 3.0 grains of hardness per gallon (GPG) must be treated or softened before being used. Water containing over 3.0 GPG will decrease the efficiency and reduce the operation life of the unit.

**Note: Product failure caused by liming or sediment buildup is not covered under warranty.**

**“THE FOREGOING WARRANTY IS IN LIEU OF ANY AND ALL OTHER WARRANTIES EXPRESSED OR IMPLIED INCLUDING ANY IMPLIED WARRANTY OF MERCHANTABILITY OR FITNESS FOR PARTICULAR PURPOSES AND CONSTITUTES THE ENTIRE LIABILITY OF APW WYOTT. IN NO EVENT DOES THE LIMITED WARRANTY EXTEND BEYOND THE TERMS STATED HEREIN.”**

9/05



---

Phone: +1 (307) 634-5801  
Fax: +1 (307) 637-8071  
Toll Free: +1 (800) 752-0863  
Website: [www.apwwyott.com](http://www.apwwyott.com)  
E-mail: [info@apwwyott.com](mailto:info@apwwyott.com)

**APW WYOTT**  
P.O. Box 1829  
Cheyenne, WY 82003