

---

# BUNN®

***LCA-2***  
***LCA-2A***  
***LCA-2 PC***  
***LCC-2***

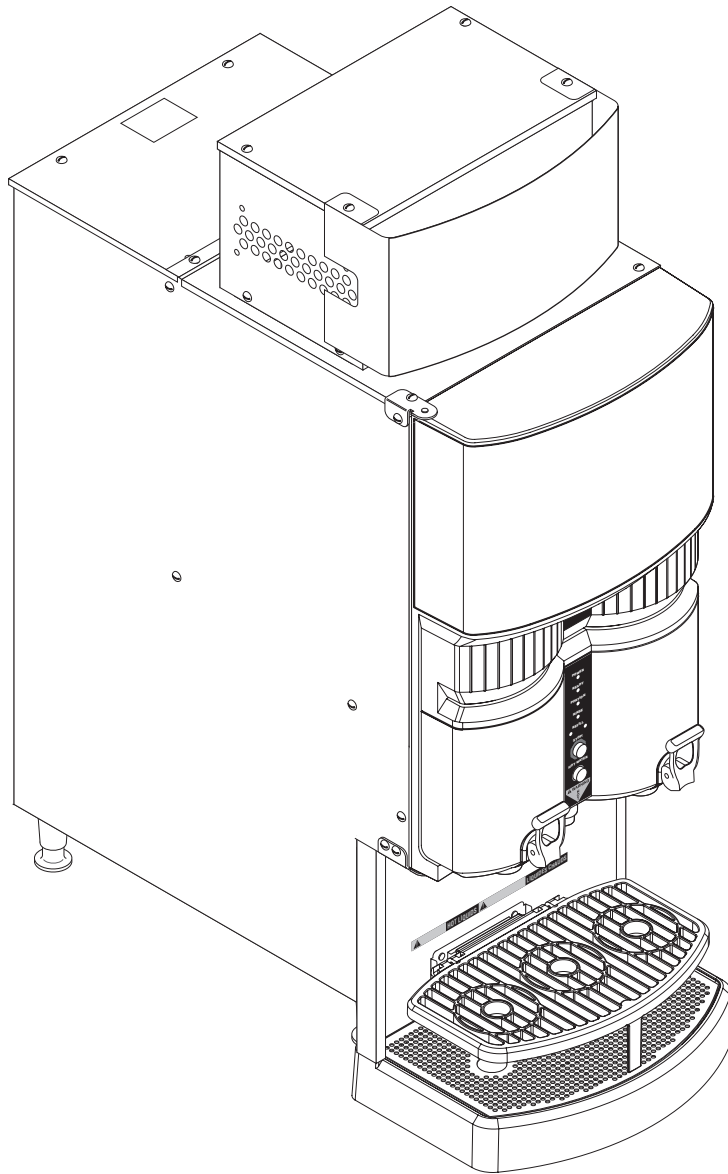

## INSTALLATION & OPERATING GUIDE

**BUNN-O-MATIC CORPORATION**

POST OFFICE BOX 3227

SPRINGFIELD, ILLINOIS 62708-3227

PHONE: (217) 529-6601 FAX: (217) 529-6644

To ensure you have the latest revision of the Operating Manual, or to view the Illustrated Parts Catalog, Programming Manual, or Service Manual, please visit the Bunn-O-Matic website, at [www.bunn.com](http://www.bunn.com). This is absolutely FREE, and the quickest way to obtain the latest catalog and manual updates. For Technical Service, contact Bunn-O-Matic Corporation at 1-800-286-6070.



## **BUNN-O-MATIC COMMERCIAL PRODUCT WARRANTY**

Bunn-O-Matic Corp. ("BUNN") warrants equipment manufactured by it as follows:

- 1) Airpots, thermal carafes, decanters, GPR servers, iced tea/coffee dispensers, MCP/MCA pod brewers thermal servers and Thermofresh servers (mechanical and digital)- 1 year parts and 1 year labor.
- 2) All other equipment - 2 years parts and 1 year labor plus added warranties as specified below:
  - a) Electronic circuit and/or control boards - parts and labor for 3 years.
  - b) Compressors on refrigeration equipment - 5 years parts and 1 year labor.
  - c) Grinding burrs on coffee grinding equipment to grind coffee to meet original factory screen sieve analysis - parts and labor for 4 years or 40,000 pounds of coffee, whichever comes first.

These warranty periods run from the date of installation BUNN warrants that the equipment manufactured by it will be commercially free of defects in material and workmanship existing at the time of manufacture and appearing within the applicable warranty period. This warranty does not apply to any equipment, component or part that was not manufactured by BUNN or that, in BUNN's judgment, has been affected by misuse, neglect, alteration, improper installation or operation, improper maintenance or repair, non periodic cleaning and descaling, equipment failures related to poor water quality, damage or casualty. In addition, the warranty does not apply to replacement of items subject to normal use including but not limited to user replaceable parts such as seals and gaskets. This warranty is conditioned on the Buyer 1) giving BUNN prompt notice of any claim to be made under this warranty by telephone at (217) 529-6601 or by writing to Post Office Box 3227, Springfield, Illinois 62708-3227; 2) if requested by BUNN, shipping the defective equipment prepaid to an authorized BUNN service location; and 3) receiving prior authorization from BUNN that the defective equipment is under warranty.

**THE FOREGOING WARRANTY IS EXCLUSIVE AND IS IN LIEU OF ANY OTHER WARRANTY, WRITTEN OR ORAL, EXPRESS OR IMPLIED, INCLUDING, BUT NOT LIMITED TO, ANY IMPLIED WARRANTY OF EITHER MERCHANTABILITY OR FITNESS FOR A PARTICULAR PURPOSE.** The agents, dealers or employees of BUNN are not authorized to make modifications to this warranty or to make additional warranties that are binding on BUNN. Accordingly, statements by such individuals, whether oral or written, do not constitute warranties and should not be relied upon.

If BUNN determines in its sole discretion that the equipment does not conform to the warranty, BUNN, at its exclusive option while the equipment is under warranty, shall either 1) provide at no charge replacement parts and/or labor (during the applicable parts and labor warranty periods specified above) to repair the defective components, provided that this repair is done by a BUNN Authorized Service Representative; or 2) shall replace the equipment or refund the purchase price for the equipment.

**THE BUYER'S REMEDY AGAINST BUNN FOR THE BREACH OF ANY OBLIGATION ARISING OUT OF THE SALE OF THIS EQUIPMENT, WHETHER DERIVED FROM WARRANTY OR OTHERWISE, SHALL BE LIMITED, AT BUNN'S SOLE OPTION AS SPECIFIED HEREIN, TO REPAIR, REPLACEMENT OR REFUND.**

In no event shall BUNN be liable for any other damage or loss, including, but not limited to, lost profits, lost sales, loss of use of equipment, claims of Buyer's customers, cost of capital, cost of down time, cost of substitute equipment, facilities or services, or any other special, incidental or consequential damages.

392, A Partner You Can Count On, AutoPOD, AXIOM, BrewLOGIC, BrewMETER, Brew Better Not Bitter, BrewWISE, BrewWIZARD, BUNN Espresso, BUNN Family Gourmet, BUNN Gourmet, BUNN Pour-O-Matic, BUNN, BUNN with the stylized red line, BUNNlink, Bunn-OMatic, Bunn-O-Matic, BUNNserve, BUNNSERVE with the stylized wrench design, Cool Froth, DBC, Dr. Brew stylized Dr. design, Dual, Easy Pour, EasyClear, EasyGard, FlavorGard, Gourmet Ice, Gourmet Juice, High Intensity, iMIX, Infusion Series, Intellisteam, My Café, Phase Brew, PowerLogic, Quality Beverage Equipment Worldwide, Respect Earth, Respect Earth with the stylized leaf and coffee cherry design, Safety-Fresh, savemycoffee.com, Scale-Pro, Silver Series, Single, Smart Funnel, Smart Hopper, SmartWAVE, Soft Heat, SplashGard, The Mark of Quality in Beverage Equipment Worldwide, ThermoFresh, Titan, trirecta, Velocity Brew, Air Brew, Air Infusion, Beverage Bar Creator, Beverage Profit Calculator, Brew better, not bitter., BUNNSource, Coffee At Its Best, Cyclonic Heating System, Daypart, Digital Brewer Control, Element, Nothing Brews Like a BUNN, Pouring Profits, Signature Series, Tea At Its Best, The Horizontal Red Line, Ultra are either trademarks or registered trademarks of Bunn-O-Matic Corporation. The commercial trirecta® brewer housing configuration is a trademark of Bunn-O-Matic Corporation.

## CONTENTS

Warranty .....	2	Brew Temperature Lockout Feature.....	13
Introduction .....	3	Programming the Dispenser Flow Rate.....	14
User Notices .....	4	Initial Fill & Heat.....	20
Electrical Requirements .....	5	Loading the Concentrate .....	21
CE Requirements .....	5	Priming the Concentrate Lines.....	21
Plumbing Requirements .....	6	Operating the Pull & Hold Dispenser.....	22
Electrical Hook-up.....	6	Operating the Preset Portion Control Dispenser .....	23
Plumbing Hook-up.....	6	Filling Cambros or other large containers .....	23
Initial Set-up .....	7	Cleaning & Preventive Maintenance.....	24
Installing the Drip Tray and Flip Down Cup Tray.....	7	Replacing the Pump Tubing .....	25
Operating Controls & Interface .....	8	Draining the Hot Water.....	26
Selecting the Correct Pump Tubing.....	9	Troubleshooting .....	27
Setting Dispenser Flow Rate .....	10	Field Calibration of the Concentrate Pumps .....	32
Adjusting Mix Ratios.....	11	Dispenser Flow Rate Calibration .....	33
FlavorGard™ Feature.....	12	Field Calibrating the Hot Water Flow Rate .....	33
Rinse Alarm Feature.....	12	Field Calibrating the Empty BIB Warning.....	34
BIB Empty Lockout Feature.....	13	Schematic Wiring Diagrams.....	35

## INTRODUCTION

The Liquid Coffee Ambient Dispenser (LCA-2) and the Liquid Coffee Chilled Dispenser (LCC-2) delivers two types of coffee made from liquid concentrate plus hot water. The dispenser can be set up for continuous draw (by the cup) for self-serve applications, or portion-control to fill carafes and decanters for wait staff. Follow the Concentrate Manufacturer's Storage and Shelf Life recommendations. Product Flavor Profile is extended with chilled product storage cabinet featured in the LCC-2.

This dispenser is designed to operate when ambient temperatures are from 32°F (0°C) minimum to 104°F (40°C) maximum.

## USER NOTICES

Carefully read and follow all notices on the equipment and in this manual. They were written for your protection. All notices are to be kept in good condition. Replace any unreadable or damaged labels.

**⚠ WARNING**

- DO NOT OVERLOAD CIRCUIT.
- ALWAYS ELECTRICALLY GROUND THE CHASSIS OR ADAPTOR PLUG.
- DO NOT DEFORM PLUG OR CORD.
- FOLLOW NATIONAL AND LOCAL ELECTRICAL CODES.
- KEEP COMBUSTIBLES AWAY.

**FAILURE TO COMPLY RISKS EQUIPMENT DAMAGE, FIRE OR SHOCK HAZARD.**

READ THE ENTIRE OPERATING MANUAL  
BEFORE USING THIS PRODUCT

00986.0002E 5/98 ©1994 Bunn-O-Matic Corporation

00986.0002

**As directed in the International Plumbing Code of the International Code Council and the Food Code Manual of the Food and Drug Administration (FDA), this equipment must be installed with adequate backflow prevention to comply with federal, state and local codes. For models installed outside the U.S.A., you must comply with the applicable Plumbing /Sanitation Code for your area.**

00656.0001

**⚠ WARNING**

**To reduce the risk of electric shock, do not remove or open cover. No user-serviceable parts inside. Authorized service personnel only. Disconnect power before servicing.**

37881.0000

**Optional Field Wiring**

208-240 V, 25.8 A, 6200 W  
1PH, 2-Wire + GND, 60HZ

or

120/208-240 V, 25.8 A, 6200 W  
1PH, 3-Wire + GND, 60HZ

28181.0003

⚠ **WARNING HOT LIQUIDS**
⚠ **AVERTISSEMENT LIQUIDES CHAUDS**

11646.0002



00824.0001



00824.0002

**REMINDER!**  
CLEAN AIR FILTER  
WEEKLY

(LOCATED UNDER THE DISPENSER)

**RECORDATORIO!**  
LIMPIAR EL FILTRO DE  
AIRE SEMANALMENTE

(LOCALIZADO DEBAJO  
DEL DISPENSADOR)

**AIR FILTER**  
CLEAN WEEKLY!

(LOCATED UNDER THE DISPENSER)

**FILTRO DE AIRE**  
LIMPIAR  
SEMANTALMENTE!

(LOCALIZADO DEBAJO  
DEL DISPENSADOR)

40054.0000

⚠ **WARNING CENTER LEG OF CUP TRAY ↓ MUST BE SUPPORTED BY THE DRIP TRAY!**

47624.0000

## ELECTRICAL REQUIREMENTS

**CAUTION:** The dispenser must be disconnected from the power source until specified in Electrical Hook-Up.

The LCA-2 and LCC-2 dispensers are supplied with a 120-volt / 15 Amp cord set and require a 2-wire, grounded, individual branch circuit rated for 120 volts AC, 15 amp, single phase, 60Hz. The mating connector must be a NEMA 5-15R.

The LCA-2C and LCC-2C dispensers are supplied with a 120-volt / 20 Amp cord set and require a 2-wire, grounded, individual branch circuit rated for 120 volts AC, 20 amp, single phase, 60Hz. The mating connector must be a NEMA 5-20R.

These dispensers can be Field Wired for 208 or 240 volt applications. This requires a 2 or 3-wire, grounded, individual branch circuit rated for 208/240 volts AC, 30 amp, single phase, 60 Hz.

**NOTE:** The internal terminal block must be rewired for 208/240 applications, (see Optional Field Wiring Diagram).

### FIELD WIRING TERMINAL BLOCK DIAGRAM Models without Master ON/OFF Switch

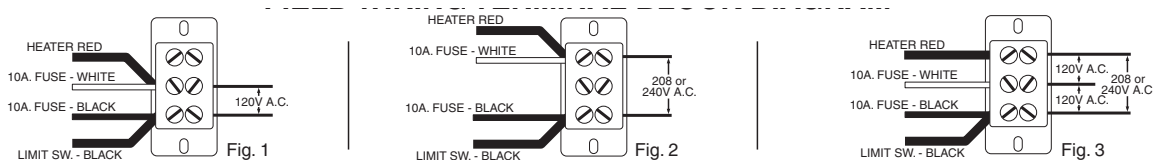

For all 208 - 240 Volt Connections: Use No. 10 AWG Wires suitable for 90°C (194°F)

1. Unit shipped per Fig. 1, wired for 120V A.C./2-Wire.
2. For 208 - 240V A.C./2-Wire per Fig. 2: Move both the Red-Heater wire and the White-Fuse wire to the Top Red Terminal as shown.
3. For 120/208 - 240V A.C./3-Wire per Fig. 3: Move the Red Heater wire to the Top Red Terminal as shown.

### FIELD WIRING TERMINAL BLOCK DIAGRAM Models with Master ON/OFF Switch

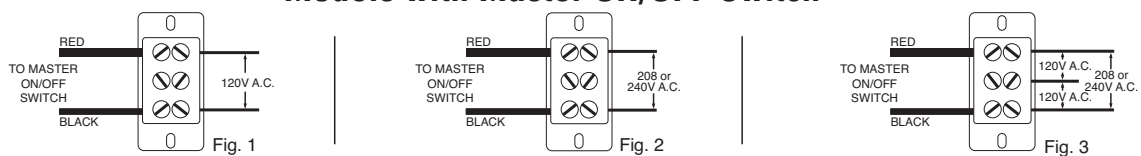

For all 208 - 240 Volt Connections: Use No. 10 AWG Wires suitable for 90°C (194°F)

1. Unit shipped per Fig. 1, wired for 120V A.C./2-Wire.
2. For 208 - 240V A.C./2-Wire per Fig. 2.
3. For 120/208 - 240V A.C./3-Wire per Fig. 3.

The LCA-2A dispenser is internally wired from the factory for 230 Volts AC Single Phase 50/60 Hz. It requires a 2-wire, grounded, individual branch circuit rated for 230 Volts AC.

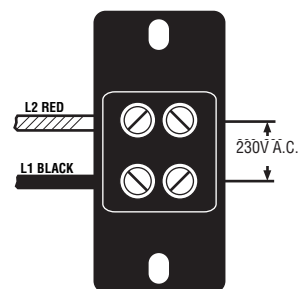

## CE REQUIREMENTS

- This appliance must be installed in locations where it can be overseen by trained personnel.
- For proper operation, this appliance must be installed where the temperature is between 5°C to 35°C.
- Appliance shall not be tilted more than 10° for safe operation.
- An electrician must provide electrical service as specified in conformance with all local and national codes.
- This appliance must not be cleaned by water jet.
- This appliance is not intended for use by persons (including children) with reduced physical, sensory or mental capabilities, or lack of experience and knowledge, unless they have been given instructions concerning use of this appliance by a person responsible for its safety.
- Children should be supervised to ensure they do not play with the appliance.
- If the power cord is ever damaged, it must be replaced by the manufacturer or authorized service personnel with a special cord available from the manufacturer or its authorized service personnel in order to avoid a hazard.
- Machine must not be immersed for cleaning.

## PLUMBING REQUIREMENTS

The dispenser may be connected to a cold or hot water system (140°F Max.) with operating pressure between 20 and 90 psi (138 and 620 kPa) from a 1/2" or larger supply line. A shut-off valve should be installed in the line before the dispenser. Install a regulator in the line when pressure is greater than 90 psi (620 kPa) to reduce it to 50 psi (345 kPa). The water inlet fitting is 3/8" flare. Dispensers set up to deliver to 1.8 Oz./sec. (53.2 ml/sec) per dispense tip, require a water supply source that can deliver a minimum of 1.7 gpm (6.4 lpm) at the inlet fitting. Dispensers set up to deliver 2.6 Oz./sec. (76.9 lpm) per dispense tip, require a water supply source that can deliver a minimum of 2.4 gpm (9.2 lpm) at the inlet fitting.

NOTE: Bunn-O-Matic recommends 3/8" tubing from the 1/2" water supply line. At least 18 inches of FDA approved flexible beverage tubing, such as reinforced braided polyethylene or silicone, before the dispenser will facilitate movement to clean the counter top. Bunn-O-Matic does not recommend the use of a saddle valve to install the dispenser. The size and shape of the hole made in the supply line by this type of device may restrict water flow.

**As directed in the International Plumbing Code of the International Code Council and the Food Code Manual of the Food and Drug Administration (FDA), this equipment must be installed with adequate backflow prevention to comply with federal, state and local codes. For models installed outside the U.S.A., you must comply with the applicable Plumbing /Sanitation Code for your area.**

## ELECTRICAL HOOK-UP

**CAUTION:** Improper electrical installation will damage electronic components.

1. An electrician must provide electrical service as specified in conformance with all local, state and federal electrical codes.
2. Using a voltmeter, check the voltage and color-coding of each conductor at the electrical source.
3. Connect the dispenser to the power source.
4. If plumbing is to be hooked up later, be sure the dispenser is disconnected from the power source. If plumbing has been hooked up, the dispenser is ready for Initial Fill & Heat.

## PLUMBING HOOK-UP

1. Flush the water line to remove any debris or foreign material.
2. Securely attach the water line to the 3/8" flare fitting, on bottom right side of the dispenser.
3. Turn on the water supply and check for leaks.

**NOTE:** Water pipe connections and fixtures directly connected to a potable water supply shall be sized, installed, and maintained in accordance with federal, state, and local codes.

## INITIAL SET-UP

**NOTE:** The LCC-2 (Chilled Unit) weighs approximately 80 lbs. (36.3 kg) and the LCA-2 (Ambient Unit) weighs approximately 70 lbs. (31.8 kg). If necessary, use more than one person when lifting or moving the dispenser.

1. Locate and remove the information packets and tube kits from top of packaging and set aside.
2. Remove foam packing and cut around the bottom of box.
3. Remove the box and the rest of the foam packing.
4. Open the dispenser door and remove the drip tray and the lower splash guard panel.
5. Set dispenser on the counter where it is to be used. **CAUTION: DO NOT LIFT ON THE DOOR.**
6. Confirm the dispenser is level on the counter.

## INSTALLING THE DRIP TRAY AND FLIP DOWN CUP TRAY

- Place the SST Cover in the recessed area of the Drip Pan.
- Slide the Drip Pan under the front of the LCA-2 and align the tabs with the legs.
- Insert the hinge pins of the Cup Tray into the notched bracket on the splash panel and rotate the Tray into place.

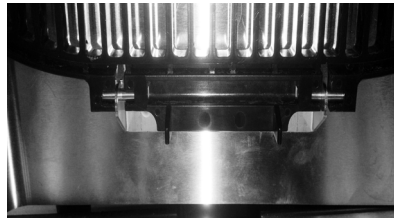

- The Cup Tray should be down for serving individual cups of coffee.
- The Cup Tray can be flipped up out of the way for filling carafe's and/or airpots.

**WARNING:** The center leg of Cup Tray must be supported by the Drip Tray during use. Do not use the Cup Tray if the Dispenser legs have been extended and/or the Drip Tray has been removed. Failure to support the Cup Tray during use can cause damage to the Cup Tray and/or spillage of HOT Liquids.

## OPERATING CONTROLS AND INTERFACE

- 1a. Dispense Handles: Pull and Hold to dispense product.
- 1b. Dispense Switches: Push and Release to dispense product for Portion Control Models.
2. Stop Switch: Momentary switch stops all dispense functions.
- 3a. Hot Water Switch: Push and Hold switch to dispense hot water from the center dispense tip.
- 3b. Push and Release switch for Portion Control Models.
4. Alternate Portion Control Switch: Momentarily pushed to select the Alternate Portion Control Volume #2.
5. Function Selector Switch: Allows the user to set the dispenser into different dispensing modes.
  - a. Rinse: Dispenses hot water only- Flushes the mix chamber and dispense tip.
  - b. Prime: Dispenses concentrates only – Primes the concentrate pump.
  - c. Normal: Normal dispense mode - Dispenses mixed product (concentrate and water).
6. Mode Selector Switch: Allows the user to set the dispenser into different operating modes.
  - a. Run: Normal operating position.
  - b. Off: Turns off all functions including tank heater and chiller.

**WARNING** - The OFF Mode does not remove AC power from the dispenser. Disconnect power source before servicing the dispenser

- c. Night: Anti-pilfering mode that disables dispensing, but keeps the tank heater and chiller (if applicable) operational.
7. Door Interlock Switch: Unit will not dispense product if the door is open.
8. Power LED: Red - illuminates when AC power is applied to dispenser.
9. Ready LED: Green - illuminates when the water is at the preset ready temperature.
10. Portion LED: Yellow - illuminates when the portion dispense option has been selected, (5 second delay).
11. Rinse LED: Yellow - illuminates when the optional preset rinse alarm time has elapsed.
12. Left Refill LED: Yellow - illuminates when the Left Concentrate BIB needs replaced.
13. Right Refill LED: Yellow - illuminates when the Right Concentrate BIB needs replaced.
14. Programming Keypad: Used in conjunction with the LCD display to program and calibrate the dispenser to customer specific requirements. *(Located behind the splash guard panel)*
15. LCD Display: Displays programming menus and fault messages. *(Located behind the splash guard panel)*

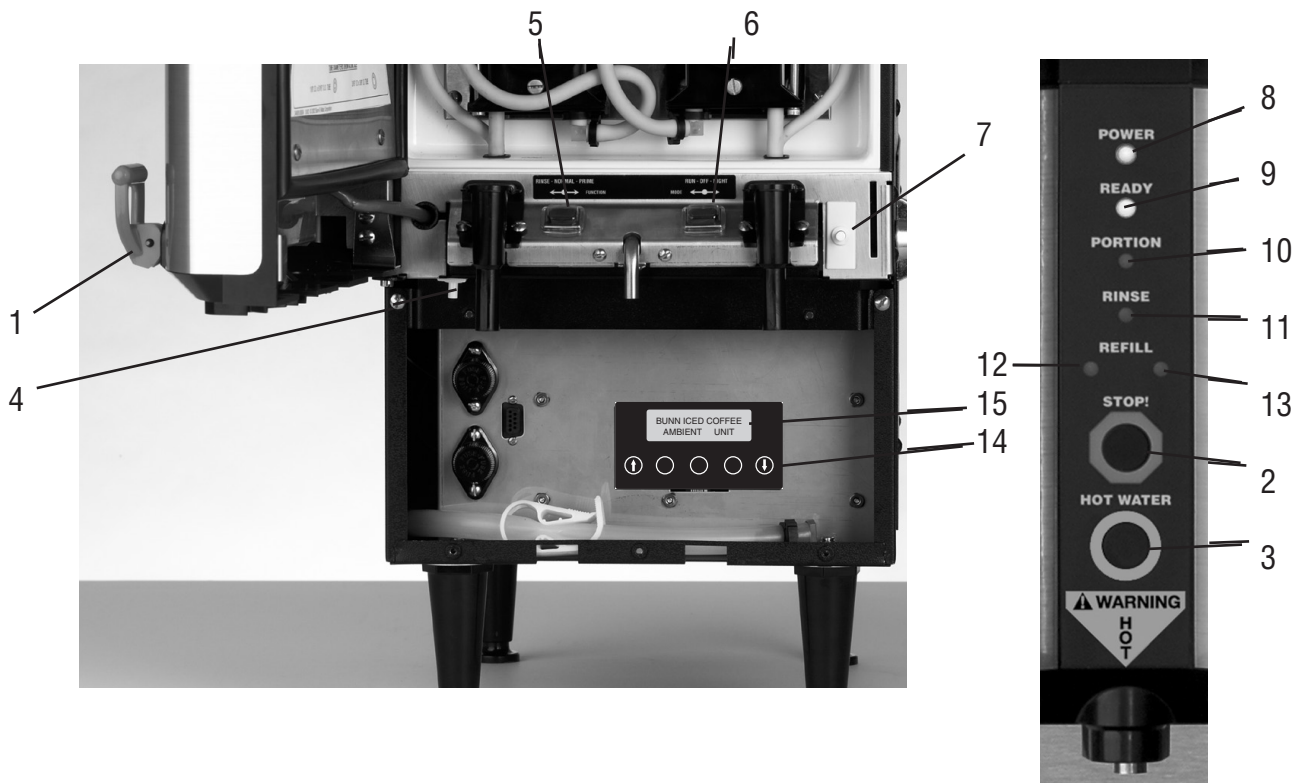



## SELECTING THE CORRECT PUMP TUBING

There are two pump tube sizes available for use with this dispenser. To determine the correct tubing for you application, first determine the dispenser flow rate you intend to use, refer to *Setting Dispenser Flow Rate*. Then look up the recommended tube size for the mix ratio of your concentrate, refer to the *Tube Selection Chart*.

TUBE SELECTION CHART																
Dispense Rate	Concentrate Ratios															
	25	30	35	40	45	50	55	60	65	70	75	80	85	90	95	100
<b>1.8 Oz/sec.</b> (53 ml/sec.)	<b>3/16" I.D. TUBING</b>				<b>1/8" I.D. TUBING</b>											
<b>2.5 Oz/sec.</b> (74 ml/sec.)	<b>3/16" I.D. TUBING</b>								<b>1/8" I.D. TUBING</b>							

Examples:

1. For a Dispenser Flow Rate of 2.5 Oz./sec (74 mL/sec) and a Mix Ratio of 35:1 – use 3/16" I.D. Tubing.
2. For a Dispenser Flow Rate of 1.8 Oz./sec (53 mL/sec) and a Mix Ratio of 60:1 – use 1/8" I.D. Tubing.

Tube kits can be purchased from BUNN-O-MATIC.

Part # 34727.1000 for 3/16" I.D. Tubing or #34728.1000 for 1/8" I.D. Tubing.

**INSTALLING THE PUMP TUBING** (Refer to the *Tubing Installation Instructions* in side the cabinet door for details.)

1. Loosen the thumbscrew securing the tubing retainer plate to the pump housing. Set it and the retainer plate aside.
2. Depress the tension screw and remove it from the notch in the pump body, releasing the spring tension on the pump band.
3. Apply lubricant (BUNN-O-MATIC part number M2531.0001) to the new pump tubing.
4. Insert the tubing onto the mix chamber port and wrap the tubing around the pump rotor, making sure that the elbow and clamps end up on the bottom side of the pump body.
5. Close the compression band reinsert the tension screw into the notch in the pump housing.
6. Replace the tubing retainer plate and tighten the thumbscrew.
7. Reconnect bag connector to the product box.
8. Repeat steps 1 through 7 for the other pump.
9. Prime the pumps. Refer to *Priming the Concentrate Lines* section.

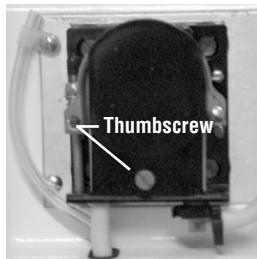

Remove Retaining Plate

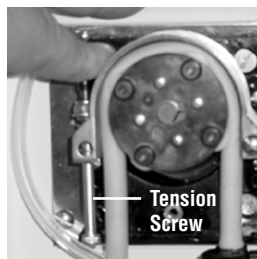

Release Spring Tension

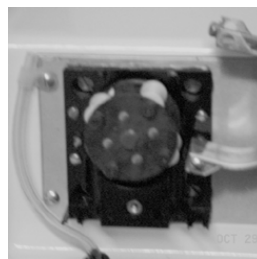

Remove Tubing

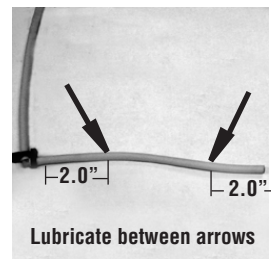

Lubricate New Tube

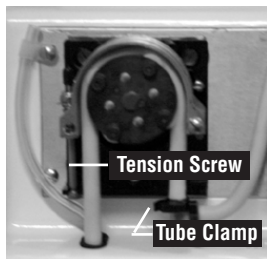

Install New Tubing

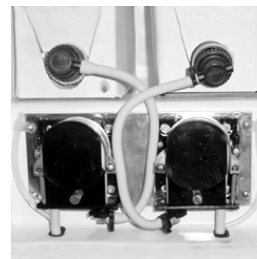

Completed Installation

## SETTING DISPENSER FLOW RATE

The dispenser comes from the factory with flow restrictors in the mix chambers. With the restrictors in place the dispense rate is about 1.8 oz./sec (53.2 ml/sec) and is used primarily for cup at a time dispensing. The flow restrictors can be removed to increase the dispense rate to about 2.5 oz./sec (74 ml/sec) for larger volume dispensing (airpots, carafes, etc.).

**NOTE:** The hot water FlowRate is fixed at approximately 1.7 oz./sec. and can not be adjusted.

### Removing the restrictors:

1. Disconnect the dispenser from the AC power source.
2. Open the Product Cabinet door.
3. Remove the concentrate tube, vent line and grommet from mix chamber ports in side the product cabinet.
4. Remove the two screws that fasten mix chamber to the control panel.
5. Gently pull mix chamber away from dispenser to expose water line connection, (you may have to rotate it slightly).
6. Disconnect FlavorGard™ sensor wire and hot water tubing from the mix chamber.
7. Remove the flow restrictor from the inlet to the mix chamber.
8. Reconnect FlavorGard™ sensor wire and hot water tubing to the mix chamber.
9. Place mix chamber back into position in the dispenser, (you may have to rotate it slightly) and secure it with the two screws
10. Reposition the grommet, vent line and pump tubing onto the mix chamber ports.

**Caution:** Failure to properly replace and secure any of the above components may result leaks and/or cause damage to the dispenser.

If you changed the Dispenser Flow Rate, you will need to reprogram the dispenser to the new rate, see *Programming the Dispenser*.

**CAUTION:** Failure to reprogram the Dispenser Flow Rates will result in inaccurate Mix Ratios.

### Reprogramming the Dispenser Flow Rate:

1. Remove the lower splash guard panel and locate the Programming module.
2. Use the Down Arrow key to enter into the programming function and scroll through the menu's to the "CAL LEFT SIDE?" menu and select "YES".
3. Scroll down to the "CAL LF WTR VOL" menu
4. Use the (+) & (-) keys to enter a volume of 50 Oz. (1478 mL). This will recalibrate the Left dispenser to the new rate.
5. Scroll down to the "CAL RT WTR VOL" menu
6. Use the (+) & (-) keys to enter a volume of 50 Oz. (1478 mL). This will recalibrate the Right dispenser to the new rate.
7. Select "Exit" to leave the programming menu.

**Note:** The default volume of 50 Oz (1478 mL), is the typical Cal Volume for a 2.5 Oz/sec Flow Rate Test, see *Field Calibration of the Concentrate Pumps / Dispenser Flow Rates*.

## ADJUSTING MIX RATIOS

The dispenser comes with the Mix Ratios preset to 35:1. The Left and Right ratios can be set for any ratios between 20:1 and 100:1, (refer the concentrate package or the supplier for the recommended ratio). Once the recommended ratio has been entered, the Ratios can be adjusted to suit local taste preferences (i.e. lighter or darker).

### **Procedure for Adjusting the Mix Ratio to Taste:**

- 1) Set the left and right dispense ratios to the recommended ratios for the concentrate to be used - refer to “PROGRAMMING THE DISPENSER” section in this manual.
- 2) Load the concentrate in the cabinet – refer to “LOADING THE CONCENTRATE” section in this manual.
- 3) Allow the dispenser to fill with water and heat up to the Ready temp – refer to “INITIAL FILL AND HEAT” section in this manual.
- 4) Prime both pumps – refer to “PRIMING THE CONCENTRATE LINES” section in this manual.
- 5) Dispense Product (left and right) for approx. 30 sec and discard. This will finish priming the lines and allow the pumps time to adjust to the target RPM.
- 6) Dispense one full cup of coffee (8 oz minimum) from both sides and evaluate.
  - a) If the coffee is too weak – Decrease the Mix Ratio slightly.
  - b) If the coffee is too strong – Increase the Mix Ratio slightly.
- 7) Repeat steps 5 and 6 until the desired taste profile is achieved

**Note:** Bunn does not recommend adjusting the Mix Ratio more than 20% from the recommended ratio. Contact your product supplier or service agent, if more than a 20 % adjustment is indicated, as there may be an error with the set up of the dispenser.

## FlavorGard™ Feature

FlavorGard™ is a patented feed back control loop that monitors the mixed product and adjusts the concentrate delivery rate to maintain a consistent mix profile, i.e. Flavor Profile. The system consists of a conductance probe mounted in the final stages of the mixing chamber, a metering pump with RPM sensor and a digital controller. Once you have completed the installation of the dispenser, entered the desired mix ratio for your concentrate, dispensed several cups of the mixed product, and are satisfied with the Flavor and Strength being delivered, simply enable FlavorGard™, (refer to FlavorGard™ in *Programming the Dispenser*).

The dispenser will automatically calibrate the system to all the factors that make up your particular mix profile, (e.g. water source, filtration system, Brand of concentrate and mix ratio selected, etc.).

**NOTE:** It is very important that you have dispensed enough product to insure that the dispenser is fully functional and you are satisfied with the Flavor Profile of the mix product before enabling FlavorGard™.

Once FlavorGard™ is enabled, the dispenser will continuously monitor the mix product as it is being dispensed and adjust the metering pump speed to maintain a consistent mixed product, thus eliminating factors such as (settling of the concentrate, tube wear, viscosity changes, liming, etc.).

The system is designed to work with in the range of variations that can be caused by these factors. The factory preset range is (+/- 10 %) and is adjustable to a Max of (+/- 15%). This insures that the FlavorGard™ system is not responding to factors that cannot be corrected by minor adjustments to the speed of the metering pump, (e.g. kinked hoses, low water pressure, severely worn tubes, empty BIB's, etc).

**NOTE:** Changes to Concentrate Ratios or Dispenser Flow Rates will automatically disable FlavorGard™. You will need to re-enable FlavorGard™, once you are satisfied with the new Flavor Profile.

## Rinse Alarm Feature

Periodic rinsing of the mix chambers and dispense tips is essential for proper maintenance and optimum performance of the dispenser. The automated Rinse Alarm feature has three levels of operation, Disabled, Warning Only and Warning with Brew Lockout, see chart for details.

<b>Alarm Level Selected</b>	<b>Alarm Mode</b>
Disabled	None
Warning Only	Rinse LED will come on 4 hrs prior to the selected time interval and remain on until the Rinse procedure has been performed. The dispenser will continue to serve product.
Warning w/ Brew Lockout	Rinse LED will come on 4 hrs prior to the selected time interval and remain on until the Rinse procedure has been performed. The dispenser will Lockout and not continue to serve product once the selected time interval has elapsed.

**NOTE:** The time interval between Rinses is adjustable from 8 to 24 hrs.

The dispenser is shipped with the automated Rinse Alarm disabled, (No Alarm). It is up to the user to determine the Rinse time interval and the level of warning required, based on their application and maintenance procedures. To enable the automated Rinse Alarm feature, refer to RINSE ALARM ? in *Programming the Dispenser*.

#### Rinse Procedure:

1. Open the cabinet door and select **Rinse** on the Function Selector switch – close the door.
  2. Place a 2 Liter (1/2 Gal) container under the Left dispense tip.
  3. Activate the Left dispenser until water flow stops automatically, approximately 20 sec.
  4. Repeat Steps 2 & 3 for the Right dispense tip.
- The Rinse LED will turn OFF, when the Rinse procedure has been satisfied for both sides.
5. Open the cabinet door and select **Normal** on the Function Selector switch – close the door.

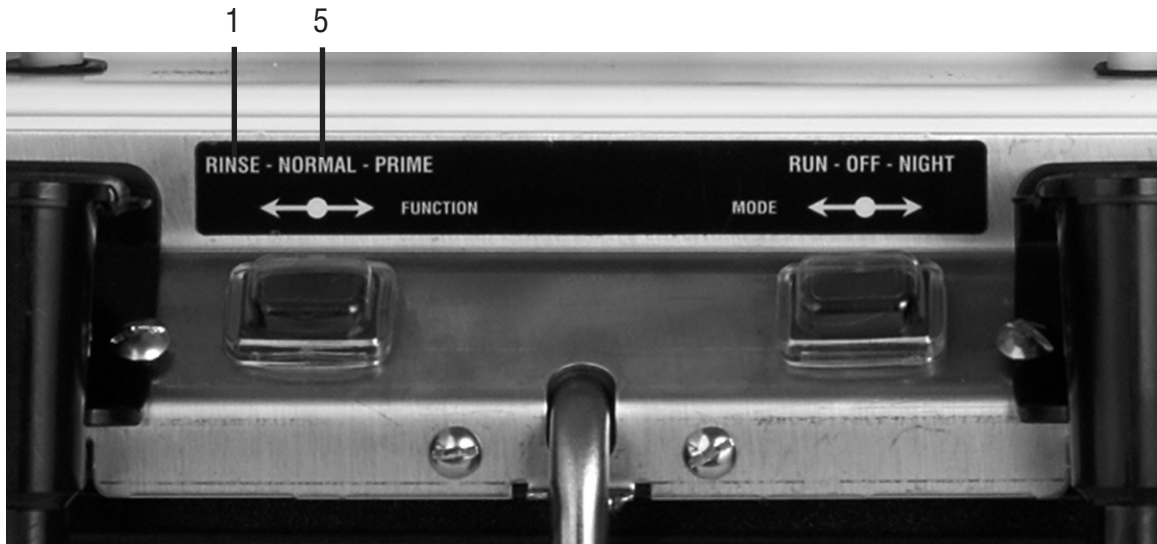

### **BIB Empty Lockout Feature**

The dispenser can be set to not dispense product when the concentrate BIB is empty. To enable this feature, first calibrate the Empty BIB Threshold (*refer to Field Calibrating the Empty BIB Warning*). Then enable the BIB Empty Lockout feature (*refer to the BIB Empty Lockout menu in Programming the Dispenser*). The dispenser will now Lockout dispensing and flash the Right or Left “REFILL LED” corresponding to the empty BIB. Once the BIB has been replaced, PRIME the concentrate line (*refer to Priming the Concentrate Lines*) and then dispense mixed product until the “REFILL LED” goes out. NOTE: If the dispenser fails to clear the BIB Empty Lockout, repeat the Priming operation a second time to insure the concentrate is flowing properly.

### **Brew Temperature Lockout Feature**

The dispenser can be set to not dispense product if the hot water is not up to the preset READY temperature. To enable this feature set the READY temperature to the minimum allowable dispense temperature. Then enable the Brew Lockout feature, refer to READY TEMP and BREW LOCKOUT, in *Programming the Dispenser*.

## PROGRAMMING THE DISPENSER

Remove the lower splash guard assembly to access the digital programming module with LCD display. Press the Down Arrow key to enter the programming menu.

Use the Up and Down Arrow keys to scroll through the menu screens.

Select Exit to leave the programming function and return to normal operations.

**NOTE 1:** Flashing menu items indicate which selection is active.

**NOTE 2:** Values shown below are the factory default values for English units.

**NOTE 3:** Values in [X - X] are the Min. and Max. for that function.

MENU SCREEN	ACTION	DESCRIPTION
<b>TANK TEMP XXX AMBIENT UNIT</b>	Use the Down Arrow Key to enter Programming Functions	Normal Display for LCA models, (No Chiller)
<b>TANK TEMP XXX CABINET TEMP XX</b>	Use the Down Arrow Key to enter Programming Functions	Normal Display for LCC models, (with Chiller)
<b>L DISPENSE RATIO (-) 35:1 (+)</b>	Use the (+) or (-) buttons to adjust the Mix Ratio	Enter the desired Mix Ratio for the concentrate used in the Left dispenser. [20:1 - 100:1]
<b>SET LF TUBE SIZE 1/8 EXIT 3/16</b>	Select tube size.	Enter Pump Tube Size to be used in the Left metering pump, (see <i>Tube Selection Chart</i> )
<b>R DISPENSE RATIO (-) 35:1 (+)</b>	Use the (+) or (-) buttons to adjust the Mix Ratio	Enter the desired Mix Ratio for the concentrate used in the Right dispenser. [20:1 - 100:1]
<b>SET RT TUBE SIZE 1/8 EXIT 3/16</b>	Select tube size.	Enter Pump Tube Size to be used in the Right metering pump, (see <i>Tube Selection Chart</i> )
<b>FLAVOR GUARD ? NO EXIT YES</b>	Select (YES) to activate. Select (NO) to deactivate.	Select Yes, if you are ready to calibrate the Flavor Guard sensor. Select NO, if you do not wish to use this feature, (see <i>Flavor Guard</i> )
If NO - go to LF DISP VOLUME menu.		
<b>LF TASTE OK ? NO EXIT YES</b>	Select (YES) or (NO)	Select YES, if you have dispensed several cups and are satisfied with the Left dispenser flavor. Select NO, if you have not run taste test.
<b>FIND LF TARGET PULL DISPENSE</b>	Place a 16 Oz. (500 mL) cup under the Left dispense tip, then activate the Left dispenser	Calibrates the Left FlavorGard™ sensor to the current MixProfile. The dispenser will shut OFF automatically when finished.
<b>RT TASTE OK ? NO EXIT YES</b>	Select (YES) or (NO)	Select YES, if you have dispensed several cups and are satisfied with the Right dispenser flavor. Select NO, if you have not run taste test.
<b>FIND RT TARGET PULL DISPENSE</b>	Place a 16 Oz. (500 mL) cup under the Right dispense tip, then activate the Right dispenser	Calibrates the Right FlavorGard™ sensor to the current MixProfile. The dispenser will shut OFF automatically when finished.

MENU SCREEN	ACTION	DESCRIPTION
<div style="border: 1px solid black; padding: 5px; text-align: center;"> <b>LOCK FLAVOR ?</b>  <b>EXIT YES</b> </div>	Select (YES) or (EXIT)	Select YES, to Lock In sensor calibration. NOTE: Display will return to "Find LF Target" if sensor calibration is out of range.
<div style="border: 1px solid black; padding: 5px; text-align: center;"> <b>FLAVORS LOCKED</b>  <b>EXIT</b> </div>	NONE	Confirms that sensor calibration was in range and accepted. Scroll down to continue.
<p>▶ Portion Control Settings for Pull and Hold Dispensers</p> <p>▶ For Portion Control Dispensers (LCA-2 PC, LCA-2C PC, LCA-2A PC) go to Full Time Portion Control Settings</p>		
<div style="border: 1px solid black; padding: 5px; text-align: center;"> <b>LF DISP VOLUME</b>  <b>(-) 4.0oz (+)</b> </div>	Use the (+) or (-) buttons to adjust the Left portion volume	Set the volume to be dispensed during a Left Portion controlled dispense to: [0 - 640 Oz.] or [0 - 18.93L]
<div style="border: 1px solid black; padding: 5px; text-align: center;"> <b>RT DISP VOLUME</b>  <b>(-) 4.0oz (+)</b> </div>	Use the (+) or (-) buttons to adjust the Right portion volume	Set the volume to be dispensed during a Right Portion controlled dispense to: [0 - 640 Oz.] or [0 - 18.93L]
<p>▶ Full Time Portion Control Settings</p>		
<div style="border: 1px solid black; padding: 5px; text-align: center;"> <b>LF DISP VOLUME 1</b>  <b>(-) 4.0oz (+)</b> </div>	Use the (+) or (-) buttons to adjust the <b>Normal</b> Left volume	Set the desired portion control volume to be dispensed during a <b>Normal</b> Left dispense to: [0 - 640 Oz.] or [0 - 18.93L]
<div style="border: 1px solid black; padding: 5px; text-align: center;"> <b>LF DISP VOLUME 2</b>  <b>(-) 0.0oz (+)</b> </div>	Use the (+) or (-) buttons to adjust the <b>Alternate</b> Left volume	Set the desired portion control volume to be dispensed during a <b>Alternate</b> Left dispense to: [0 - 640 Oz.] or [0 - 18.93L]
<div style="border: 1px solid black; padding: 5px; text-align: center;"> <b>RT DISP VOLUME 1</b>  <b>(-) 4.0oz (+)</b> </div>	Use the (+) or (-) buttons to adjust the <b>Normal</b> Right volume	Set the desired portion control volume to be dispensed during a <b>Normal</b> Right dispense to: [0 - 640 Oz.] or [0 - 18.93L]
<div style="border: 1px solid black; padding: 5px; text-align: center;"> <b>RT DISP VOLUME 2</b>  <b>(-) 0.0oz (+)</b> </div>	Use the (+) or (-) buttons to adjust the <b>Alternate</b> Right volume	Set the desired portion control volume to be dispensed during a <b>Alternate</b> Right dispense to: [0 - 640 Oz.] or [0 - 18.93L]
<div style="border: 1px solid black; padding: 5px; text-align: center;"> <b>WATER DISP VOL 1</b>  <b>(-) 0.0oz (+)</b> </div>	Use the (+) or (-) buttons to adjust the <b>Normal</b> Hot Water volume	Set the desired portion control volume to be dispensed during a <b>Normal</b> Hot Water dispense: [0 - 640 Oz.] or [0 - 18.93L]
<div style="border: 1px solid black; padding: 5px; text-align: center;"> <b>WATER DISP VOL 2</b>  <b>(-) 0.0oz (+)</b> </div>	Use the (+) or (-) buttons to adjust the <b>Alternate</b> Hot Water volume	Set the desired portion control volume to be dispensed during a <b>Alternate</b> Hot Water dispense: [0 - 640 Oz.] or [0 - 18.93L]

MENU SCREEN	ACTION	DESCRIPTION
TANK TEMP 180 (-) EXIT (+)	Use the (+) or (-) buttons to adjust the target Temp.	Sets the water Tank temperature [120 - 200°F] or [49 - 93°C]
READY TEMP 175 (-) EXIT (+)	Use the (+) or (-) buttons to adjust the target Temp.	Sets the hot water Ready temperature. Typically set to the minimum desired dispense temp.
CABINET TEMP 65 (-) EXIT (+)	Use the (+) or (-) buttons to adjust the target Temp.	LCC Models Only: Sets the Chilled Cabinet target temperature [50 - 75°F] or [4 - 24°C]
LF PRODUCT DISP .OGAL RESET?	Select (RESET) to clear total	Selecting Reset will clear the Current accumulated volume of concentrate dispensed through the Left dispenser. Gal (Liters)
LF PRODUCT DISP .OGAL	NONE	Displays the Total accumulated volume of concentrate dispensed through the Left dispenser. Not Re-settable. Gal (Liters)
RT PRODUCT DISP .OGAL RESET?	Select (RESET) to clear total	Selecting Reset will clear the Current accumulated volume of concentrate dispensed through the Right dispenser. Gal (Liters)
RT PRODUCT DISP .OGAL	NONE	Displays the Total accumulated volume of concentrate dispensed through the Right dispenser. Not Re-Settable. Gal (Liters)

The following functions can be Password Protected. If you wish to prevent others from accessing these functions, enter a 4 digit code of your choice. Record your password code [ \_ \_ \_ \_ ], as you will need it to access these functions in the future.

ENTER PASSWORD (-) 0 (+)	Use the (+) or (-) buttons to enter password.	Enter the access Code to view the remaining functions. Factory Default = 0.
SET PASSWORD ? (-) 0 (+)	Use the (+) or (-) buttons to change the password.	Enter your own Code to prevent access to the remaining functions. [0 to 9999]
SELECT UNITS ENG EXIT METRIC	Select the preferred units	Used to select the preferred units of measurement. (Oz., Gal, deg F) or (mL, L, deg C)
CHILLED UNIT ? NO EXIT YES	Select (YES) or (NO)	LCA Models without Chiller select (NO) LCC Models with Chiller select (YES)
RINSE ALARM ? NO EXIT YES	Select (YES) or (NO)	Selecting Yes will enable the Rinse Alarm function, (see <i>Rinse Alarm</i> )

If NO - go to BIB EMPTY LOCKOUT menu.



MENU SCREEN	ACTION	DESCRIPTION
<b>RINSE TIME ? (-) 12 Hrs (+)</b>	Use the (+) or (-) buttons to adjust Rinse Alarm delay	Enter the desired time between required Rinse Cycles in hours, [8 - 24 hrs.]
<b>RINSE LOCKOUT ? NO EXIT YES</b>	Select (YES) to enable	Select YES to Lockout dispensing until the Rinse Alarm has been cleared. Default is NO
<b>BIB EMPTY LOCKOUT NO EXIT YES</b>	Select (YES) to enable	Select YES to Lockout dispensing until the Concentrate BIB has been replaced. Default is NO
<b>BREW LOCKOUT ? NO EXIT YES</b>	Select (YES) to enable	Select YES to Lockout dispensing until the hot water tank is at READY Temp. Default is NO
<b>DLY REPEAT DISP (-) 0 SEC (+)</b>	Use the (+) or (-) buttons to adjust the Delay Time	Enter the desired time delay before allowing the next dispense to take place, [0 - 10 sec.]

The following functions are for diagnostic and troubleshooting purposes and typically do not have to be adjusted. Contact your local service agent for assistance before making changes to these functions.

<b>CAL LEFT SIDE ? EXIT YES</b>	Select (YES) to enable	Selecting Yes will enable the Left Dispenser Calibration routine, (see <i>Field Calibration</i> before attempting to calibrate the dispenser).
-------------------------------------	------------------------	--

If NO - go to CAL RIGHT SIDE menu.

<b>CAL LEFT PUMP ? PULL DISPENSE</b>	Place a 50 mL (#34843.1000) graduated cylinder under the Left dispense tip, then activate the Left Dispenser	The Left Pump will dispense concentrate for 20 seconds, then shut off automatically. Collect and measure the concentrate dispensed.
<b>CAL LF PUMP VOL (-) 43mL (+)</b>	Use the (+) or (-) buttons to enter volume collected	Enter the volume of concentrate measured from the Left Pump in mL, (not Oz.) regardless of Preferred Units selected.
<b>CAL LF WTR FLOW ? PULL DISPENSER</b>	Place a 64 Oz. (2000 mL) container under the Left dispense tip, then activate the Left Dispenser	The Left Dispenser will dispense hot water for 20 seconds, then shut off automatically. Collect and measure the water dispensed.
<b>CAL LF WTR VOL (-) 36.00Z (+)</b>	Use the (+) or (-) buttons to enter volume collected	Enter the volume of the water measured from the Left dispenser in Oz. (mL).
<b>CAL LEFT SIDE ? EXIT YES</b>	NONE	Scroll down to bypass this screen.
<b>CAL RIGHT SIDE ? EXIT YES</b>	Select (YES) to enable Calibration routine.	Selecting Yes will enable the Right Dispenser Calibration routine, (see <i>Pump Calibration</i> ) prior to calibrating the dispenser.

MENU SCREEN	ACTION	DESCRIPTION
<b>CAL RIGHT PUMP ? PULL DISPENSER</b>	Place a 50 mL (#34843.1000) graduated cylinder under the Right dispense tip, then activate the Right Dispenser	The Right Pump will dispense concentrate for 20 seconds, then shut off automatically. Collect and measure the concentrate dispensed.
<b>CAL RT PUMP VOL (-) 43mL (+)</b>	Use the (+) or (-) buttons to enter volume collected	Enter the volume of concentrate measured from the Right Pump in mL(not Oz.) regardless of Preferred Units selected.
<b>CAL RT WTR FLOW PULL DISPENSER</b>	Place a 64 Oz. (2000 mL) container under the Right dispense tip, then activate the Right Dispenser	The Right Dispenser will dispense hot water for 20 seconds, then shut off automatically. Collect and measure the water dispensed.
<b>CAL RT WTR VOL (-) 36.00Z (+)</b>	Use the (+) or (-) buttons to enter volume collected	Enter the volume of the water measured from the Right dispenser in Oz. (mL)
<b>CAL RIGHT SIDE ? EXIT YES</b>	NONE	Scroll down to bypass this screen.
For Portion Control Dispensers (LCA-2 PC, LCA-2C PC, LCA-2A PC) only		
<b>CAL HOT WTR FLO ? PULL DISPENSE</b>	Place a 64 Oz. (2000 mL) container under the Hot Water dispense tip, then activate the Hot Water Dispenser	The Hot Water Dispenser will dispense for 20 seconds, then shut off automatically. Collect and measure the water dispensed.
<b>CAL HOT WTR VOL (-) 34.00Z (+)</b>	Use the (+) or (-) buttons to enter volume collected	Enter the volume of the water measured from the Hot Water Dispenser in Oz. (mL)
<b>XXX CAL -&gt; XXX (-) TankTemp (+)</b>	Use the (+) or (-) buttons to adjust temperature reading	Adjust the display reading to match a calibrated probe inserted next to the Tank Sensor, °F (°C).
<b>FlvrGrdRange 10% (-) EXIT (+)</b>	Use the (+) or (-) buttons to adjust % value	Used to set the maximum adjustment the Flavor Guard feature is allowed to make, [3 - 15%].
<b>LfFlvrGrdTargets RPM XXX-CON XXX</b>	NONE	Displays the Left Dispenser target RPM and Conductance Reading, (Diagnostics Only)
<b>RtFlvrGrdTargets RPM XXX-CON XXX</b>	NONE	Displays the Right Dispenser target RPM and Conductance Reading, (Diagnostics Only)

If NO - skip to next menu.

For Portion Control Dispensers (LCA-2 PC, LCA-2C PC, LCA-2A PC) only

MENU SCREEN	ACTION	DESCRIPTION
<b>BIB EMPTY -&gt; 500</b> <b>(-) EXIT (+)</b>	Use the (+) or (-) buttons to adjust empty BIB threshold	Used to set the Conductance Threshold for the Empty BIB warning. Default is 500
<b>XX REFILL -&gt; 155</b> <b>(-) EXIT (+)</b>	Use the (+) or (-) buttons to adjust Refill threshold	Used to set the Conductance Threshold for the Tank Refill Probe.
<b>WTR START DELAY</b> <b>(-) .15SEC (+)</b>	Use the (+) or (-) buttons to adjust delay time	Dispense Valve ON Delay. Eliminates weak mix at the beginning of a dispense.
<b>WTR STOP DELAY</b> <b>(-) .15SEC (+)</b>	Use the (+) or (-) buttons to adjust delay time	Dispense Valve OFF Delay. Flushes the mix chamber at the end of a dispense.
<b>TEST LED'S ?</b> <b>NO EXIT YES</b>	Select (YES) or (NO)	LED diagnostics. Selecting YES will light all Front Door LED's.
<b>TEST SWITCHES ?</b> <b>UseSwitchToTest</b>	NONE	Switch Diagnostic: Activate switches separately to test. Display will indicate which Switch has been activated. NOTE: Door Interlock switch must be held closed.
<b>TEST REFILL ?</b> <b>EXIT YES</b>	Momentarily depress (YES)	Refill Valve Diagnostic: Press YES to momentarily energize the Solenoid. CAUTION: Inlet Valve will open and water will flow, if connected and turned ON.
<b>TEST HEATER ?</b> <b>EXIT YES</b>	Momentarily depress (YES)	Tank Heater Diagnostic: Press YES to momentarily energize the Tank Heater Circuit. CAUTION: AC power will be applied to the Tank Heater Circuit.
<b>ENTER ASSET #</b> <b>(-) 000000 (+)</b>	Use the (+) or (-) buttons to adjust the ASSET NUMBER	Allows the user the option of entering an Asset Number. Default is 000000
<b>SERIAL #</b> <b>LCA 0000000</b>	NONE	Displays the manufacture's Serial Number (should be identical to the Serial Number on the machine Data Plate)
<b>VIEW FAULTS?</b> <b>(-) EXIT (+)</b>	Select (+) to view Fault Conditions	This unit stores the last 3 Fault Conditions in memory for diagnostic purposes.
<b>LATEST FAULT</b> <b>NO FAULTS</b>	Use (+) or (-) to scroll through the Faults	Displays up to 3 FAULT Conditions or NO FAULTS, if nothing has failed since the last "Reset Factory Defaults".
<b>FACTORY DEFAULTS</b> <b>NO YES</b>	Select (YES) or (NO)	CAUTION: Selecting YES will RESET all Programming Functions to the Factory Default settings. NOTE: On LCC Models the Chiller will have to be reset to the ON condition, (see <i>Chilled Unit</i> programming function).

## INITIAL FILL & HEAT

1. Select **Normal** on the Function Selector Switch and **Run** on the Mode Selector Switch.
  2. Confirm the water supply is on.
  3. Connect the dispenser to the power source. The Red POWER LED will illuminate and water will begin flowing into the tank. The dispenser will automatically stop filling when the tank is full. The dispenser will not begin heating the water until after the tank is filled. Dispenser models with product chillers will begin to cool the cabinet at this time.
  4. The Green READY LED will illuminate when the tank temperature reaches the preset ready temperature.
- Note:** The time required to heat the water initially will vary depending on the *AC Power* supplied to the dispenser.

While the tank is heating, the dispenser may be readied for use as described in *Programming Functions & Basic Operations*.

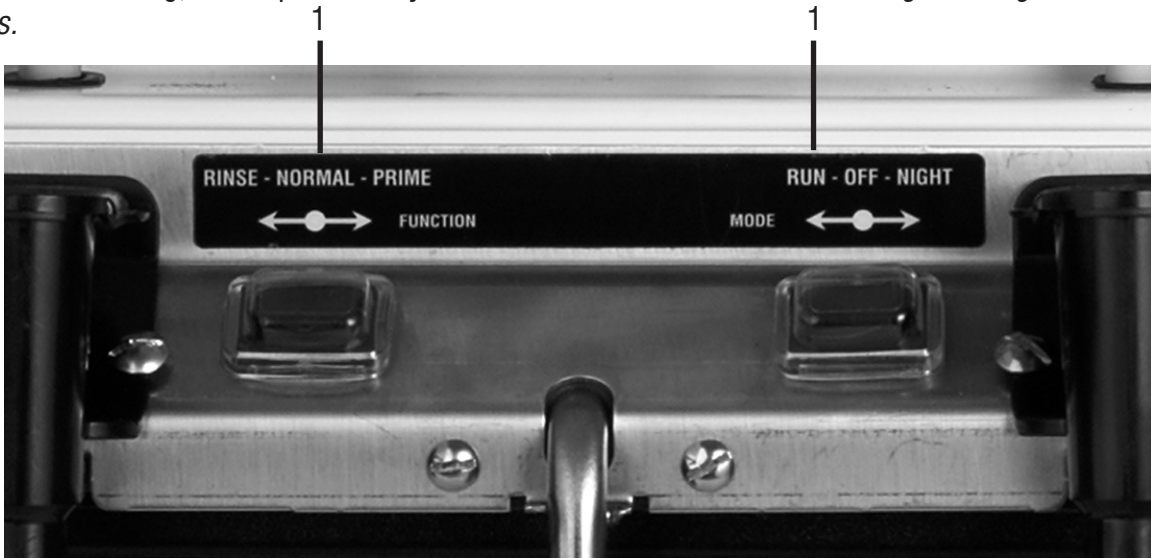

## LOADING THE CONCENTRATE

1. Thoroughly mix concentrate by vigorously shaking the product Bag-In-Box (BIB).
2. Pull the BIB connector through the hole provided in the box and place it on the drip tray with the connector facing up. (See Fig. 1)
3. Open the dispenser door and locate the appropriate left or right BIB Adapter fitting.
4. Pull the Adapter fitting down and connect it to the BIB. (See Fig. 2)
5. Place the BIB upright in the machine, rotating it into position with the connector facing forward.
6. Rotate the BIB Adapter to avoid sharp bends in the tubing and allow it to be routed between the two pumps.  
Refer to the *Tube Installation Decal* on the door for proper routing. (See Fig. 3)
7. Close the cabinet door.

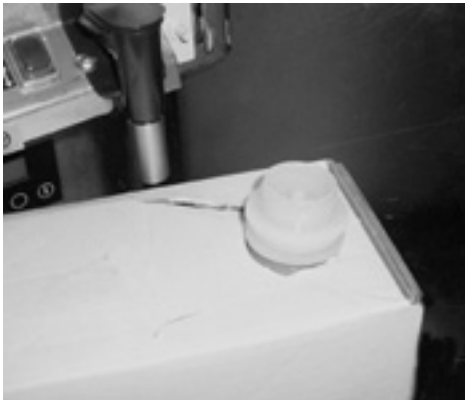

Fig. 1

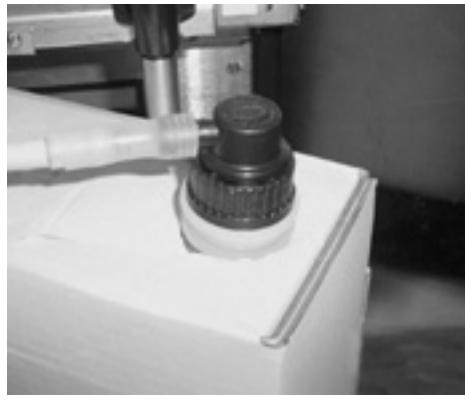

Fig. 2

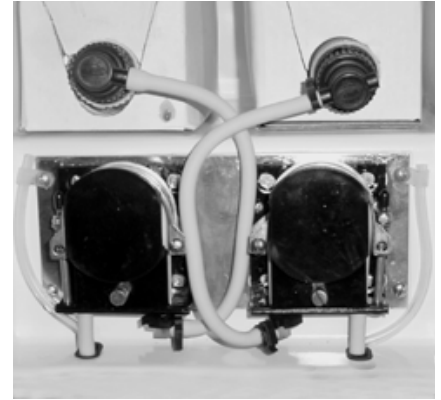
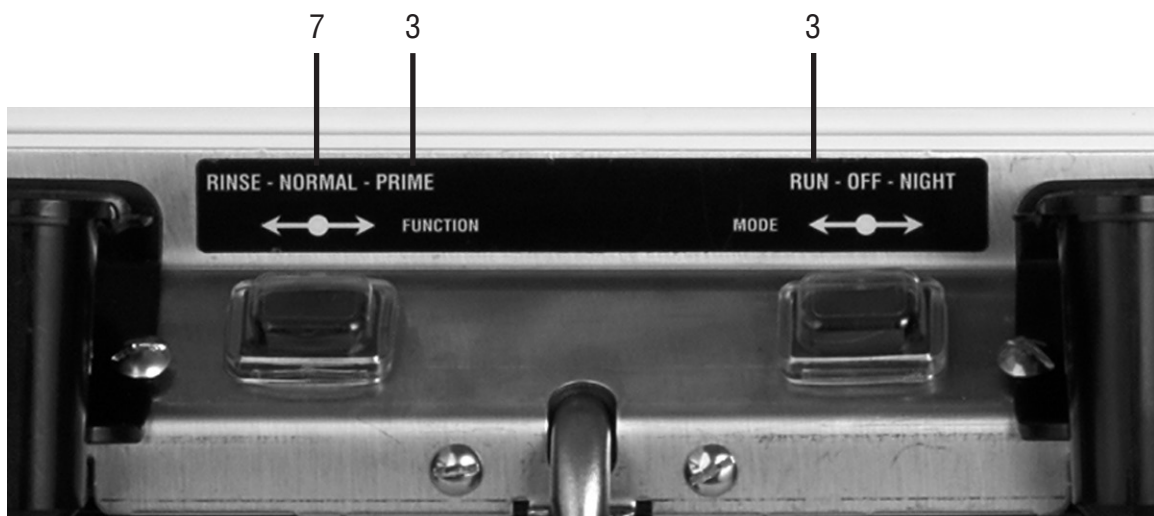

Fig. 3

## PRIMING THE CONCENTRATE LINES

1. Open the dispenser door.
2. Load concentrate per instructions in the section titled *Loading the Concentrate*.
3. Select **Prime** on the Function Selector Switch and **Run** on the Mode Selector Switch.
4. Close the dispenser door.
5. Place a container under the appropriate dispense tip.
6. Activate the appropriate dispenser until concentrate flows from the dispense nozzle. Priming may take 5 to 10 seconds.
7. Open the dispenser door, select **Normal** on the Function Selector Switch, and then close door.

**Note:** Concentrate may continue to drip out of dispense tip. The user may wish to run a Rinse Cycle (refer to *Rinsing*) after Priming the dispenser to clean out the remaining concentrate.



## OPERATING THE PULL & HOLD DISPENSER

(Models LGA-2, LGA-2C, LGA-2A, LCC-2, LCC-2C, LCC-2A)

Set the Function Selector Switch to **Normal** and the Mode Selector Switch to **Run**.

1. Pull and Hold Dispense Mode (Cup at a time)
  - a. Place cup on the cup tray beneath the desired dispensing tip. For a large container, flip the cup tray up and place the container on top of the drip tray.
  - b. Pull and Hold the corresponding dispense handle until the cup or other container is full.
  - c. Remove cup or container.
2. Portion Dispense Mode (Preset volume dispensing) Refer to *Programming Functions* on how to set this volume.
  - a. Place the appropriate size container beneath the desired dispensing tip. For large containers, flip the cup tray up and place the container on top of the drip tray.
  - b. Momentarily press the Portion Switch. The Portion LED will illuminate for 5 seconds after the Portion Switch is pressed.
  - c. Momentarily pull the corresponding dispense handle, then release. If the user waits longer than 5 seconds to pull the handle, the dispenser will default back to the Pull & Hold Mode. Portion Dispense Mode can be disabled at any time during the portion dispense by either momentarily pulling the Dispense Handle again or pressing the Stop button.
  - d. Wait for container to fill and the dispenser to quit dispensing, then remove container.
3. Hot Water Dispense
  - a. Place container under the hot water dispenser (center of machine). For large containers, flip the cup tray up and place the container on top of the drip tray.
  - b. Push and hold the Hot Water Switch until the water reaches the desired level, then release.
  - c. Remove container.

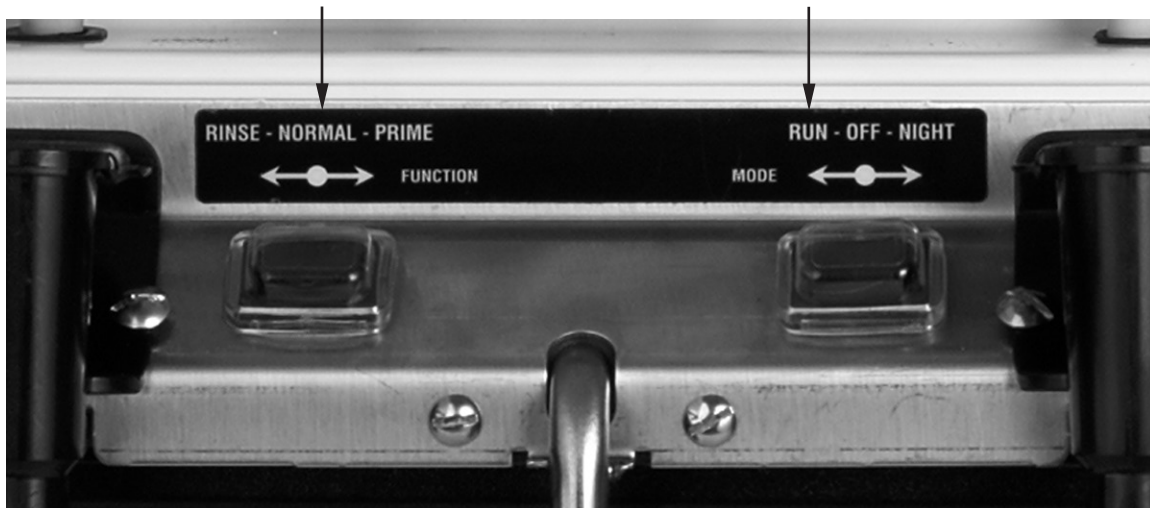

### Filling Cambros or other large containers:

The dispenser is designed primarily for cups or other small containers that will fit under the dispense tips. However, it may be used to fill larger containers (up to 2 Gal) by use of an extension hose on the dispense tip. Removing the Flow Restrictors will increase the dispenser flow rate to 2.5 Oz/sec. (74 mL/sec.) and reduce the time to fill larger containers, (see *Setting Dispenser Flow Rate*.)

Care must be taken to insure that the mixed product flows freely from the dispense tip into the container.

1. Use a 5/8" I.D. or larger, NSF (National Sanitation Foundation) approved hose.
2. Use as short a hose as possible with no loops, bends or kinks in it.
3. Insure that the outlet of the hose is below the dispense tip and that the mixed product flows freely into the container

A properly sized and positioned hose will not run full or back up into the dispense tip. Failure to follow these directions can alter the mix ratio and/or cause flooding of the vent tube.

**NOTE:** The temperature of the product being dispensed will start to drop after ~2 gal. continuous draw.

Recovery time will be dependent on the temperature of the supply water and the voltage at which the heater coil is being operated.

## OPERATING THE PRESET PORTION CONTROL DISPENSER

(Models LCA-2 PC, LCA-2C PC, LCA-2A PC)

Set the Function Selector Switch to Normal and the Mode Selector Switch to Run.

### Dispensing Preset Portions of Coffee or Hot Water

1. Primary Volume Portion Dispense Mode. (Volume 1) Refer to *Programming Functions* on how to set this amount.
  - a. Place cup on the cup tray beneath the desired dispensing tip. For a large container, flip the cup tray up and place the container on top of the drip tray.
  - b. Momentarily press the appropriate dispense switch. The dispenser will automatically dispense the beverage at the preset amount. Allow the mix chamber to drain at the end of the cycle.
  - c. Remove cup or container.
2. Alternate Volume Portion Dispense Mode. (Volume 2) Refer to *Programming Functions* on how to set this volume.
  - a. Place the appropriate size container beneath the desired dispensing tip. For large containers, flip the cup tray up and place the container on top of the drip tray.
  - b. Momentarily press the Portion Switch. The Portion LED will illuminate for 5 seconds after the Portion Switch is pressed.
  - c. Momentarily press the corresponding Dispense Switch. If the user waits longer than 5 seconds to push the switch, the dispenser will default back to the Primary Volume preset amount. Alternate Portion Dispense Mode can be disabled at any time during the portion dispense by either momentarily pushing the Dispense Switch again or pressing the Stop button.
  - d. Wait for the container to fill and the dispenser to quit dispensing, then remove the container.

### Push and Hold Dispensing of Coffee or Hot Water

Push and Hold Dispense Mode. See *Programming Functions* on how to set the Preset Volume to Zero.

- a. Place cup on the cup tray beneath the desired dispensing tip. For a large container, flip the cup tray up and place the container on top of the drip tray.
- b. Push and hold the corresponding dispense switch until the container is full.
- c. Remove cup or container.

### Filling Cambros or other large containers:

The dispenser is designed primarily for cups or other small containers that will fit under the dispense tips. However, it may be used to fill larger containers (up to 5 Gal) by use of an extension hose on the dispense tip. Removing the Flow Restrictors will increase the dispenser flow rate to 2.5 Oz/sec. (74 mL/sec.) and reduce the time to fill larger containers, (see *Setting Dispenser Flow Rate*.)

Care must be taken to insure that the mixed product flows freely from the dispense tip into the container.

1. Use a 5/8" I.D. or larger, NSF (National Sanitation Foundation) approved hose.
2. Use as short a hose as possible with no loops, bends or kinks in it.
3. Insure that the outlet of the hose is below the dispense tip and that the mixed product flows freely into the container

A properly sized and positioned hose will not run full or back up into the dispense tip. Failure to follow these directions can alter the mix ratio and/or cause flooding of the vent tube.

**NOTE:** The temperature of the product being dispensed will start to drop after ~2 gal. continuous draw. Recovery time will be dependent on the temperature of the supply water and the voltage at which the heater coil is being operated.

## CLEANING & PREVENTATIVE MAINTENANCE

### General Cleaning and Sanitizing Procedures

**Note:** The BUNN® Liquid Coffee Dispenser incorporates a “user selectable” rinse reminder feature, which lights the Rinse LED on the front panel and disables dispensing when it is time to rinse. See *Programming Functions* to activate this feature.

### Daily: RINSING

1. Open the dispenser door.
2. Select **Rinse** on the Function Selector Switch and **Run** on the Mode Selector Switch.
3. Close the dispenser door.
4. Place a 1/2 gal (2 liter) container under the appropriate dispense nozzle or nozzles.
5. Activate the Dispenser of the appropriate side or sides for approximately twenty seconds or until the hot water is clear or has no concentrate coloring in it.
6. Open the dispenser door, select **Normal** on the Function Selector Switch, and then close door.

**Note:** To clear the “Rinse” alarm, activate each dispenser until the flow stops automatically (approx. 20 seconds for each tip). The “Rinse” alarm LED will turn off when the Rinse Procedure has been satisfied for both sides.

### Daily: PARTS WASHING

1. Remove and wash the drip tray, drip tray cover, and cup tray in a mild detergent solution. Rinse thoroughly.
2. Wipe splash panel, area around dispense nozzles, door, and cabinet with a clean damp cloth.

### Weekly: SANITIZING

1. Open the dispenser door.
2. Select **Prime** on the Function Selector Switch and **Run** on the Mode Selector Switch.
3. Remove the bag connector from the product box and disassemble or prop open the internal valve to allow free flow of product through the connector. **NOTE:** Cutting the mating fittings from an empty bag makes an excellent “free flowing” connector for this purpose.
4. Place the bag connector into a one-gallon (3.8 liter) container of warm soapy tap water 140°F (60°C).
5. Place an empty container under dispense tip and activate the corresponding Dispenser until the clean soapy water is dispensed from the dispense tip.
6. Repeat steps 4 and 5 with warm tap water 140°F (60°C) to rinse the soapy water from the pump tubing. Continue dispensing until the water is clear, and no soapy water is being dispensed.
7. Prepare 2.5 gallons (9.46L) of sanitizing solution by dissolving 1 packet of Kay 5 sanitizer into 2.5 gallons (9.46L) of 120°F (48.9°C) water to ensure 100 ppm of available chlorine.
8. Again, repeat steps 4 and 5 with the sanitizing solution. Once sanitizing solution is visible, continue to dispense for 1 minute. Release handle and allow solution to sit for 5 minutes.
9. After soaking for 5 minutes, activate the dispense switch a second time, this time for 2 minutes. After 2 minutes, release the dispense switch.
10. Repeat step 6 to flush out the sanitizing solution from the pump tubing.
11. Remove the mating connector from the bag connector.
12. Reattach the bag connector to product box.
13. Select **Normal** on the Function Selector Switch and **Run** on the Mode Selector Switch.
14. Activate the Dispenser until concentrate/water mixture appears. Then dispense one 12 ounce (354.9 ml) glass of concentrate/water mixture and discard.
15. Repeat steps 1 through 14 for other dispense head.
16. Wipe internal and external surfaces with a clean, damp cloth.



## PREVENTIVE MAINTENANCE

Bunn-O-Matic® Corporation recommends that preventive maintenance be performed at regular intervals. Maintenance should be performed by a qualified service technician. For Technical Service, contact Bunn-O-Matic® Corporation at 1-800-286-6070.

**NOTE: Replacement parts or service caused by failure to perform required maintenance is not covered by warranty. Replace pump hoses every 6-Months or as needed.**

## REPLACING THE PUMP TUBING

The pumps and tubing used in the dispenser are designed to give maximum performance and long life. However, the tubes are a wear item and must be replaced periodically. How long the tubes last is dependent on usage and properties of the concentrate. Excessive wear will reduce the output of the pumps resulting in a weak mixed beverage. **Bunn-O-Matic recommends replacing the Pump Tubing a minimum of once every 6 months or sooner if warranted.**

Refer to the *Tube Replacement Instruction* on the Cabinet door for details.

1. Rinse the pump tubing with warm tap water (Refer to steps 1 - 5 of the *Weekly Sanitizing instructions*) prior to removing the tubes to avoid concentrate spills.
2. Loosen the thumbscrew securing the tubing retainer plate to the pump housing. Set it and the retainer plate aside.
3. Depress the tension screw and remove it from the notch in the pump housing, releasing the spring tension on the pump band.
4. Open the compression band and gently pull the pump tube from around the pump's rotor.
5. Inspect the pump bands for signs of wear. Replace if necessary.
6. Apply lubricant (BUNN-O-MATIC part number M2531.0001) to the new pump tubing's rotor side.
7. Insert the tube onto the mix chamber port, then wrap the new tubing around the pump rotor, making sure that the elbow and clamps end up on the bottom side of the pump housing.
8. Depress the tension screw and insert it in the notch in the pump body, reapplying spring tension on the pump band.
9. Replace the tubing retainer plate and tighten the thumbscrew.
10. Repeat steps 1 through 9 for the other pump.

**Note:** Replacement Tube/Adapter Kits can be purchased from BUNN-O-MATIC.

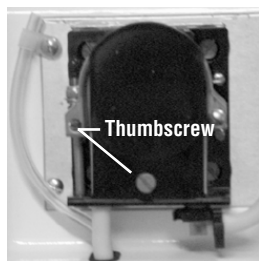

Remove Retaining Plate

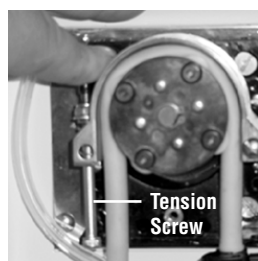

Release Spring Tension

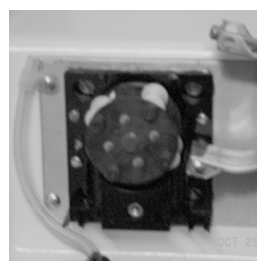

Remove Tubing

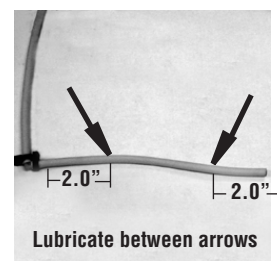

Lubricate New Tube

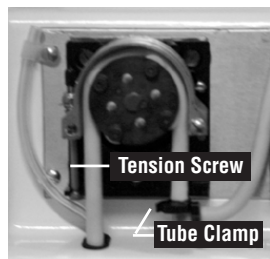

Install New Tubing

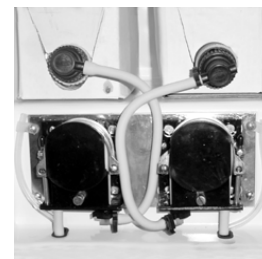

Completed Installation

## DRAINING THE HOT WATER TANK

**CAUTION:** The dispenser must be disconnected from the power source throughout these steps.

1. Disconnect the dispenser from the power source.
2. Shut off and disconnect the incoming water supply.
3. Remove the front splash panel.
4. Pull out drain tube to empty into a sink or a container with a minimum of five-gallon capacity.
5. Make sure drain clamp is closed. Then, remove drain plug.
6. Direct tube into sink or container and open drain clamp. Continue draining tank until ALL of the water is out. Be very careful with the draining water because it can be very hot.
7. Close drain clamp, insert drain plug, place drain tube back into machine, and replace splash panel.

**Note:** The dispenser must be refilled using the *Initial Fill & Heat* steps before reconnecting the power source.

## Troubleshooting

A troubleshooting guide is provided to suggest probable causes and remedies for the most likely problems encountered. If the problem remains after exhausting the troubleshooting steps, contact the Bunn-O-Matic Technical Service Department.

- Only qualified service personnel should perform inspection, testing, and repair of electrical equipment.
- Shorting the terminals or the application of external voltages to electronic components may result in component or circuit board failure.
- Intermittent operation of electronic circuit boards is unlikely. board failure will normally be permanent. If an intermittent condition is encountered, the cause will likely be a switch contact or a loose wire connection at a terminal or crimp.
- Solenoid removal requires interrupting the water supply to the valve. Damage may result if solenoids are energized for more than ten minutes without a supply of water.
- The use of two wrenches is recommended whenever plumbing fittings are tightened or loosened. This will help avoid twists and kinks in the tubing.
- Make certain that all plumbing connections are sealed and all electrical connections are tight and isolated.
- This dispenser is heated at all times. Keep away from combustibles.

### **WARNING:**

- Exercise extreme caution when servicing electrical equipment.
- Disconnect the brewer from the power source when servicing, except when electrical tests are specified. The red “Power LED” on the door indicates that the unit is connected to AC Power.
- Follow recommended service procedures.
- Replace all protective shields or safety notices.

### **Front Panel LED Display Messages**

<b>Power LED “OFF”</b> No AC Power	Dispenser Not plugged in. AC Circuit Breaker OFF	Check Power Cord Check the AC Power Circuit Breaker Service Required
<b>Ready LED “OFF”</b> Water Temp. Too Low	Usage has exceeded the capacity of the Tank Heater	Check Tank Temp Setting Check Ready Temp. Setting Service Required: Change the Supply Voltage, see <i>Optional Field Wiring</i>
<b>Rinse LED “ON”</b> Rinse Timer	Rinse Cycle Required	Rinse Dispenser, see <i>Rinse Procedure</i>
<b>Rinse LED “FLASHING”</b> Rinse Lockout Enabled	Dispenser Locked Out Rinse Cycle Required	Rinse Dispenser, see <i>Rinse Procedure</i>
<b>Portion LED “ON”</b> Portion Dispense Enabled	Alternate Portion Dispenser Volume #2 has been selected	Activate the Dispenser within 5 sec. to dispense the pre-selected volume.

## Troubleshooting (Continued)

<p><b>Left Refill LED “ON”</b> Left BIB Empty</p>	<p>Concentrate BIB is Empty. BIB Not properly connected Tubing kinked or blocked Empty BIB warning set too high</p>	<p>Replace BIB, see <i>Loading the Concentrate</i> Check BIB Connector Fittings Check Tubing Installation Check Threshold, see <i>Field Calibrating the Empty BIB Warning</i></p>
<p><b>Right Refill LED “ON”</b> Right BIB Empty</p>	<p>Concentrate BIB is Empty. BIB Not properly connected Tubing kinked or blocked Empty BIB Warning set too high</p>	<p>Replace BIB, see <i>Loading the Concentrate</i> Check BIB Connector Fittings Check Tubing Installation Check Threshold, see <i>Field Calibrating the Empty BIB Warning</i></p>
<p><b>Left Refill LED “FLASHING”</b> Empty BIB Lockout Enabled</p>	<p>Left Dispenser will not operate</p>	<p>Replace BIB, see <i>loading the Concentrate</i></p>
<p><b>Right Refill LED “FLASHING”</b> Empty BIB Lockout Enabled</p>	<p>Right Dispenser will not operate</p>	<p>Replace BIB, see <i>loading the Concentrate</i></p>
<p><b>All LED’s “FLASHING”</b> Fault Detected</p>	<p>The Dispenser has detected an Internal Fault</p>	<p>Remove the lower splash guard to view the Fault message, See Diagnostics. After the fault has been repaired or corrected - Hold the “Stop” button for 10 seconds to clear the message.</p>

## Troubleshooting (Continued)

### Dispenser Diagnostics-LCD Display

Screen Displayed	Possible Cause	Troubleshooting Procedures
LF TARGET RPM TOO HIGH !! ↑↓	1. The Tube Size selected for the Left Hand Dispenser is too small for the application.	Refer to “Selecting the Correct Pump Tubing” section of the manual.
TUBE TOO SMALL CHECK DISP RATIO	2. The Ratio selected for the Left Hand Dispenser is not correct for the application.	Refer to recommended Dispense Ratio on the product label.
RT TARGET RPM TOO HIGH !! ↑↓	1. The Tube Size selected for the Right Hand Dispenser is too small for the application.	Refer to “Selecting the Correct Pump Tubing” section of the manual.
TUBE TOO SMALL CHECK DISP RATIO	2. The Ratio selected for the Right Hand Dispenser is not correct for the application.	Refer to recommended Dispense Ratio on the product label.
LF TARGET RPM TOO LOW !! ↑↓	1. The Tube Size selected for the Left Hand Dispenser is too large for the application.	Refer to “Selecting the Correct Pump Tubing” section of the manual.
TUBE TOO LARGE CHECK DISP RATIO	2. The Ratio selected for the Left Hand Dispenser is not correct for the application.	Refer to recommended Dispense Ratio on the product label.
RT TARGET RPM TOO LOW !! ↑↓	1. The Tube Size selected for the Right Hand Dispenser is too large for the application.	Refer to “Selecting the Correct Pump Tubing” section of the manual.
TUBE TOO LARGE CHECK DISP RATIO	2. The Ratio selected for the Right Hand Dispenser is not correct for the application.	Refer to recommended Dispense Ratio on the product label.
LEFT BIB EMPTY!  REPLACE PRODUCT  CHECK THRESHOLD	1. Concentrate BIB is Empty. 2. BIB Not properly connected. 3. Tubing kinked or blocked. 4. Empty BIB Warning set too high.	Replace BIB, <i>see loading the Concentrate</i> Check BIB Connector Fittings Check Tubing installation Check Threshold, <i>see Field Calibrating the Empty BIB Warning</i>
RIGHT BIB EMPTY!  REPLACE PRODUCT  CHECK THRESHOLD	1. Concentrate BIB is Empty. 2. BIB Not properly connected. 3. Tubing kinked or blocked. 4. Empty BIB Warning set too high.	Replace BIB, <i>see loading the Concentrate</i> Check BIB Connector Fittings Check Tubing installation Check Threshold, <i>see Field Calibrating the Empty BIB Warning</i>

## Troubleshooting (Continued)

Screen Displayed	Possible Cause	Troubleshooting Procedures
OVERFLOW CUP FULL. EMPTY CUP	<ol style="list-style-type: none"> <li>1. Refill valve stuck open</li> <li>2. Faulty refill probe</li> <li>3. Faulty overflow switch</li> </ol>	<p>Service Required</p> <p>Service Required</p> <p>Service Required</p>
HEATING TIME TOO LONG ↑↓ CHECK HEATING CIRCUIT	<ol style="list-style-type: none"> <li>1. Tank Heater failure</li> <li>2. Triac failure</li> <li>3. Tank Temp. sensor failure</li> </ol>	<p>Service Required</p> <p>Service Required</p> <p>Service Required</p>
FILL TIME TOO LONG ↑↓ CHECK WATER SUPPLY	<ol style="list-style-type: none"> <li>1. Water shut off to dispenser</li> <li>2. Inlet Solenoid Valve failure</li> </ol>	<p>Check water supply shut-off</p> <p>Service Required</p>
TANK TEMP SENSOR OUT OF RANGE ↑↓ CHECK FOR BAD CONNECTIONS	<ol style="list-style-type: none"> <li>1. Corresponding Temperature Sensor Probe wire(s) broken or disconnected</li> </ol>	<p>Service Required</p>
COOL TEMP SENSOR OUT OF RANGE ↑↓ CHECK FOR BAD CONNECTIONS	<ol style="list-style-type: none"> <li>1. Corresponding Temperature Sensor Probe wire(s) broken or disconnected.</li> <li>2. Product cabinet temperature too low.</li> </ol>	<p>Service Required</p> <p>Service Required</p>
EVAP TEMP SENSOR OUT OF RANGE ↑↓ CHECK FOR BAD CONNECTIONS	<ol style="list-style-type: none"> <li>1. Corresponding Temperature Sensor Probe wire(s) broken or disconnected.</li> <li>2. Evaporator temperature too low.</li> </ol>	<p>Service Required</p> <p>Service Required</p>
TANK TEMP SENSOR OUT OF RANGE ↑↓ CHECK WIRE FOR SHORTS	<ol style="list-style-type: none"> <li>1. Corresponding Temperature Sensor Probe wire(s) shorted to housing, or to each other.</li> </ol>	<p>Service Required</p>
COOL TEMP SENSOR OUT OF RANGE ↑↓ CHECK WIRE FOR SHORTS	<ol style="list-style-type: none"> <li>1. Corresponding Temperature Sensor Probe wire(s) shorted to housing, or to each other.</li> <li>2. Product cabinet temperature too high.</li> </ol>	<p>Service Required</p> <p>Service Required</p>

## Troubleshooting (Continued)

Screen Displayed	Possible Cause	Troubleshooting Procedures
EVAP TEMP SENSOR OUT OF RANGE ↑↓ CHECK WIRE FOR SHORTS	1. Corresponding Temperature Sensor Probe wire(s) shorted to housing, or to each other.  2. Evaporator temperature too high.	Service Required  Service Required
LEFT PUMP FAULT! CHK PUMP WIRING ↑↓ CHK RPM SENSOR CHK TUBING AREA	1. Motor failure  2. RPM Sensor failure	Service Required  Service Required
RT PUMP FAULT! CHK PUMP WIRING ↑↓ CHK RPM SENSOR CHK TUBING AREA	1. Motor failure  2. RPM Sensor failure	Service Required  Service Required
COOLER FAULT! EVAP TEMP TOO HI ↑↓ CHECK EVAP FAN CHK EVAP SENSOR	1. Cabinet circulating fan failure  2. Ice build up on evaporator coils  3. Evaporator sensor failure	Service Required  Service Required  Service Required
COOLING TIME TOO LONG ↑↓ CHECK AIR FILTER CHECK COOLING UNIT	1. Air intake filter clogged  2. Wiring failure  3. Compressor failure	Clean Air Filter  Check wiring harness for breaks, shorts, open connectors  Service Required
COND PROBE FAULT CHECK COND PROBES ↑↓ CHK DISP SWITCHES CHK CONNECTIONS	1. Concentrate buildup on probes  2. Machine dispensing continuously  3. Water flowing continuously	Check pump & tubing for proper installation. Clean probes Dispense switch failure, Service Required Dispense valve leaking, Service Required
JUMPER FAULT! CONFIG NOT VALID ↑↓ CHECK J-18 ON CONTROL BOARD	1. Invalid wire harness configuration	Service Required

## Field Calibration of the Concentrate Pumps / Dispenser Flow Rates

The factory set Default Values for the Pump & Dispenser Flow Rates are very accurate and typically do not need to be field calibrated. However, if the mix ratio accuracy is ever in question, this procedure can be used to recalibrate the unit in the field.

Equipment Required:

50 to 100 ml graduated cylinder, with 1 ml graduations.

64 Oz (2000 ml) graduated container.

Remove the lower splash guard assembly to access prior to starting this procedure

**NOTE:** You can calibrate either the Concentrate Pump or the Dispenser Flow Rate independently. Simply scroll through the menu screen to the desired section and perform only those steps.

### Calibrating the Left Side Dispenser

#### Concentrate Pump Calibration

1. Select PRIME on the Function Selector Switch. (refer to *Priming the Concentrate Lines*).
2. Place a container under the Left Dispense Tip and prime the concentrate lines until a steady stream of concentrate comes out the tip (approximately 10 seconds).
3. Stop the Priming and allow the tip to stop dripping. Discard the concentrate collected.
4. Select NORMAL on the Function Selector Switch.
5. Locate the programming module and use the Arrow Down key to scroll through LCD screens until CAL LEFT SIDE appears and press the YES button.
6. The CAL LEFT PUMP menu screen will be displayed. Place a 50 ml graduated cylinder under Left Dispense Tip and activate the Left Dispenser momentarily. The dispenser will run the Left Concentrate Pump for 20 seconds and then shut OFF automatically.
7. Keep the graduated cylinder under dispense tip until all the concentrate has dripped out.
8. Measure the volume of concentrate collected in the graduated cylinder.

Acceptable ranges for the volume collected

<u>Tubing Size</u>	<u>Volume Collected</u>
3/16" tubing	40 - 47 ml.
1/8" tubing	16 - 22 ml

9. If the amount collected is not within the acceptable range, empty the graduated cylinder and repeat STEPS 6 – 8.
10. If the amount collected is still not within range, replace the pump tubing with a new Tube Kit, (refer to the *Tube Replacement Instructions*).
11. When satisfied with the volume of concentrate collected, press the Down Arrow Key
12. The CAL LF PUMP VOL menu screen will be displayed. Use the (-) / (+) keys to adjust number displayed to the amount measured in STEP 8.

(Continued Next Page)



## **Field Calibration of the Concentrate Pumps / Dispenser Flow Rates (Continued)**

### Dispenser Flow Rate Calibration

13. Press Down Arrow Key to display the CAL LF WTR FLO menu screen.
14. Place a 64 Oz (2000 ml) graduated container under Left Dispense Tip and Pull the Left Dispense Handle momentarily. The dispenser will dispense water for 20 seconds and then shut OFF automatically.
15. Keep the graduated container under dispense tip until all the water stops dripping.
16. Measure the volume of water collected in the graduated container.

Acceptable ranges for the volume collected

<u>Dispenser Flow Rate</u>	<u>Volume Collected</u>
1.8 Oz/sec (53 ml/sec) w/ flow restrictor	32 - 38 Oz, (946 - 1124 ml)
2.5 Oz/sec (74 ml/sec) w/o flow restrictor	46 - 52 Oz ,(1360 - 1538 ml)

17. If the amount collected is not within the acceptable range, empty the graduated container and repeat STEPS 14 – 16
18. If the amount collected is still not within range, inspect the dispense valves, tubing and mix chamber for lime, kinks or other obstructions.
19. When satisfied with the volume of concentrate collected, press the Down Arrow Key.
20. The CAL LF WTR VOL screen will be displayed. Use the (-) / (+) keys to adjust number displayed to the amount measured in STEP 16.
21. Press Down Arrow Key again to exit the CAL LEFT SIDE functions.

### **Calibrating the Right Side Dispenser**

Repeat STEPS 1-21 above for the “CAL RIGHT SIDE” menus.

### **Field Calibrating the Hot Water Flow Rate**

1. Locate the programming module and use the Arrow Down key to scroll through the LCD screen until “CAL HOT WTR FLO?” appears.
2. Place a 64 Oz (2000 ml) graduated container under Hot Water Tip and press the hot water switch. The unit will dispense Hot Water for 20 seconds and then shut OFF automatically. Keep the graduated container under the dispense tip until all the water stops dripping.
3. Measure the volume of water collected in the graduated container. The acceptable range for the volume collected is 32 - 38 Oz. (946 - 1124 ml).
4. If the amount collected is not within the acceptable range, empty the container and repeat steps 2 & 3.
5. If the amount collected is still not within range, inspect the hot water valve, tubing and fittings for lime, kinks, or other obstructions.
6. When satisfied with the volume of concentrate collected, press the Down Arrow Key.
7. The “CAL HOT WTR VOL” screen will be displayed. Use the (-) / (+) keys to adjust number displayed to the amount measured in step 3.
8. Press Down Arrow Key again to exit this function.

## **Field Calibrating the Empty BIB Warning**

The dispenser will automatically turn on the Left or Right “REFILL LED”, see *Operating Controls and Interface*, when the corresponding BIB is Empty. The Refill message is triggered when the FlavorGard™ sensor reading drops below the minimum setting. The factory set minimum is 500 and should be correct for most locations. However, in some areas the hardness of the local water supply may effect this reading. If the Refill message doesn't come on when the BIB is empty or the message comes on too early and there is still concentrate left in the BIB, use the following procedure to find the correct Empty BIB threshold.

### **Calibrating The Empty BIB Threshold**

1. Remove the lower splash guard assembly to access the digital programming module with LCD display.
2. Open the cabinet door and set the Function Switch to the “Rinse” position. Close the door.
3. Place a large container under the Left dispenser tip, then activate and hold the left dispenser.
4. Dispense long enough to rinse all the concentrate out of the mix chamber and for the Conductance reading to stabilize and stop dropping.
5. Record the nominal Conductance value displayed. (NOTE: It is typical for this value fluctuate (+/- 25) points about the nominal value}. This is the conductance reading of the water in your area.
6. Repeat steps 3, 4 & 5 for the Right dispenser.
7. Add 100 points to the larger of the Left or Right side Conductance value. This is the new Empty BIB threshold value for your dispenser.
8. Enter this new value into the Empty BIB Alarm threshold, see *Programming the Dispenser*.

# SCHEMATIC WIRING DIAGRAM

## LCA-2/LCA-2, PC/LCA-2C/LCA-2C, PC/LCC-2/LCC-2C

(Older models may not have the Master Sw., 10 Amp Fuses or Product Cabinet Fan)

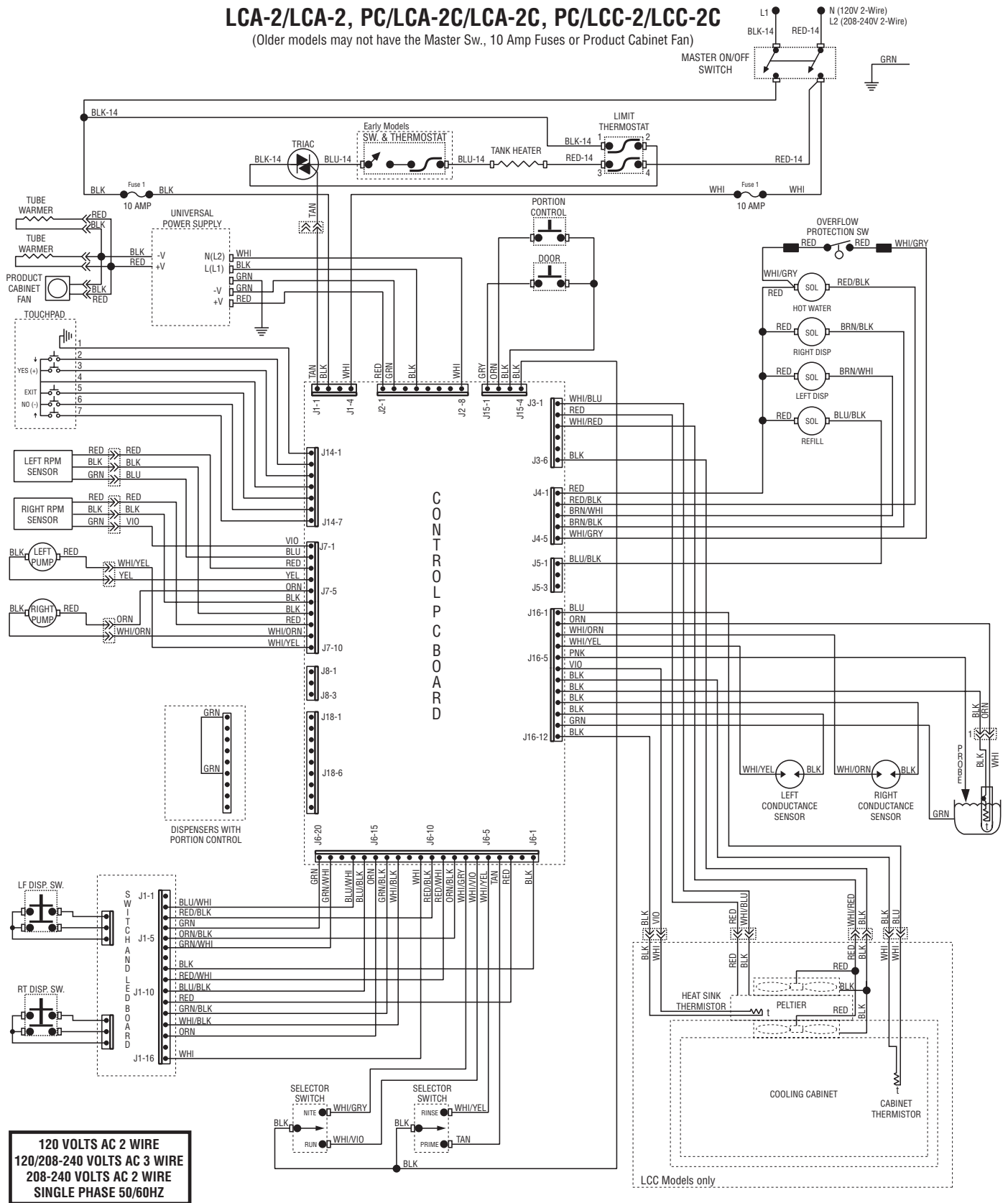

# SCHEMATIC WIRING DIAGRAM LCC-2A/LCA-2A/LCA-2A, PC

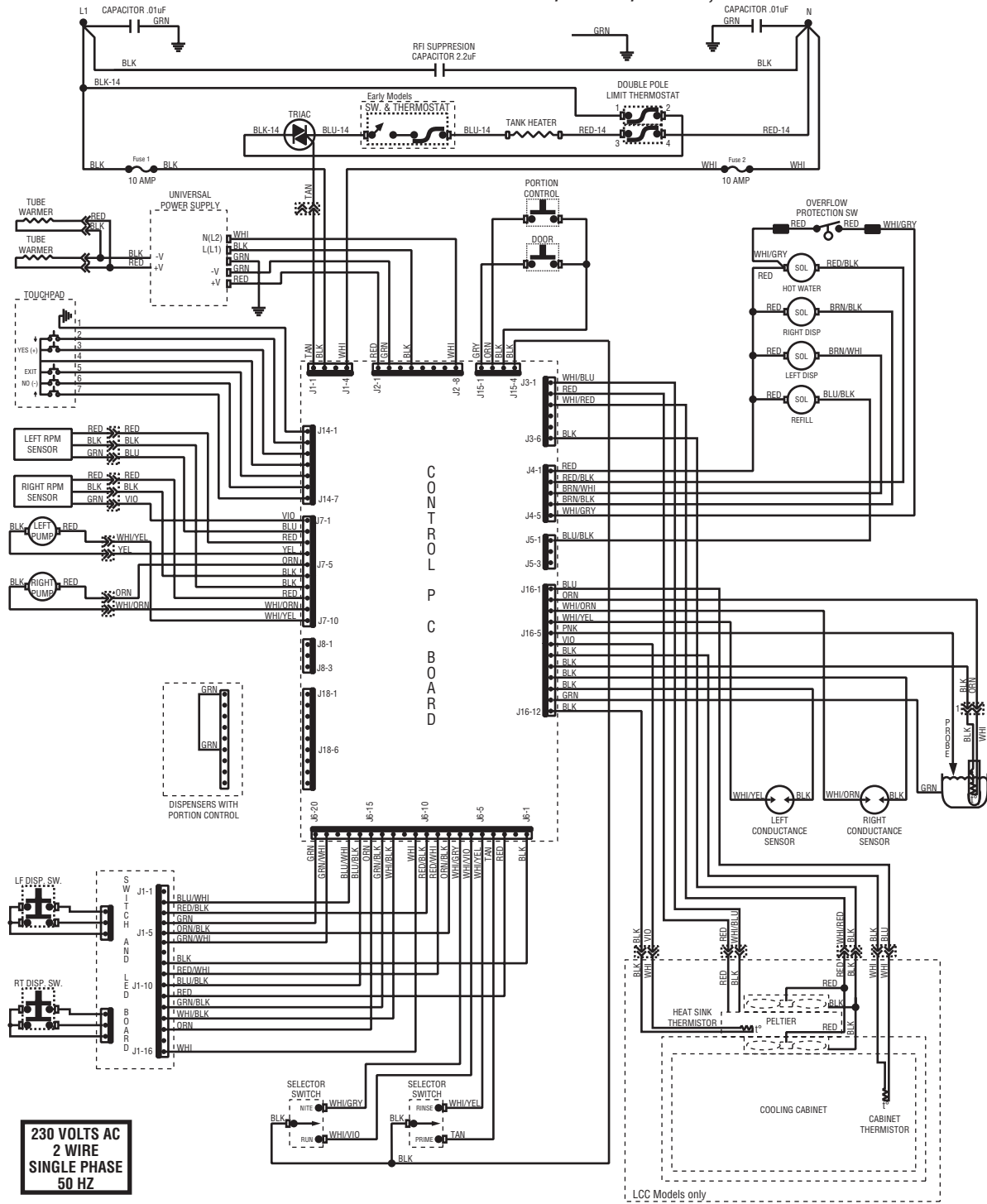

**230 VOLTS AC**  
**2 WIRE**  
**SINGLE PHASE**  
**50 HZ**